



1	Information Brochure	2	Application Brochure	3	Rough In Wiring	4	Wiring Brochure	5	Data Brochure	6	Job Record
	Choose controls to match application		Design your mechanical applications		Rough-in wiring instructions		Wiring and installation of specific control		Control settings and sequence of operation		Record settings & wiring details for future reference

Introduction

The tekmarNet®4 thermostat 543 operates two stages of heating equipment. The 543 can operate as a stand alone device, or communicate with a group of tekmarNet®4 thermostats.

Features

- tN4 Compatible
- 2 Auxiliary Temperature Sensor Input
- Pulse Width Modulation
- Programmable Setback Scheduling
- Scenes

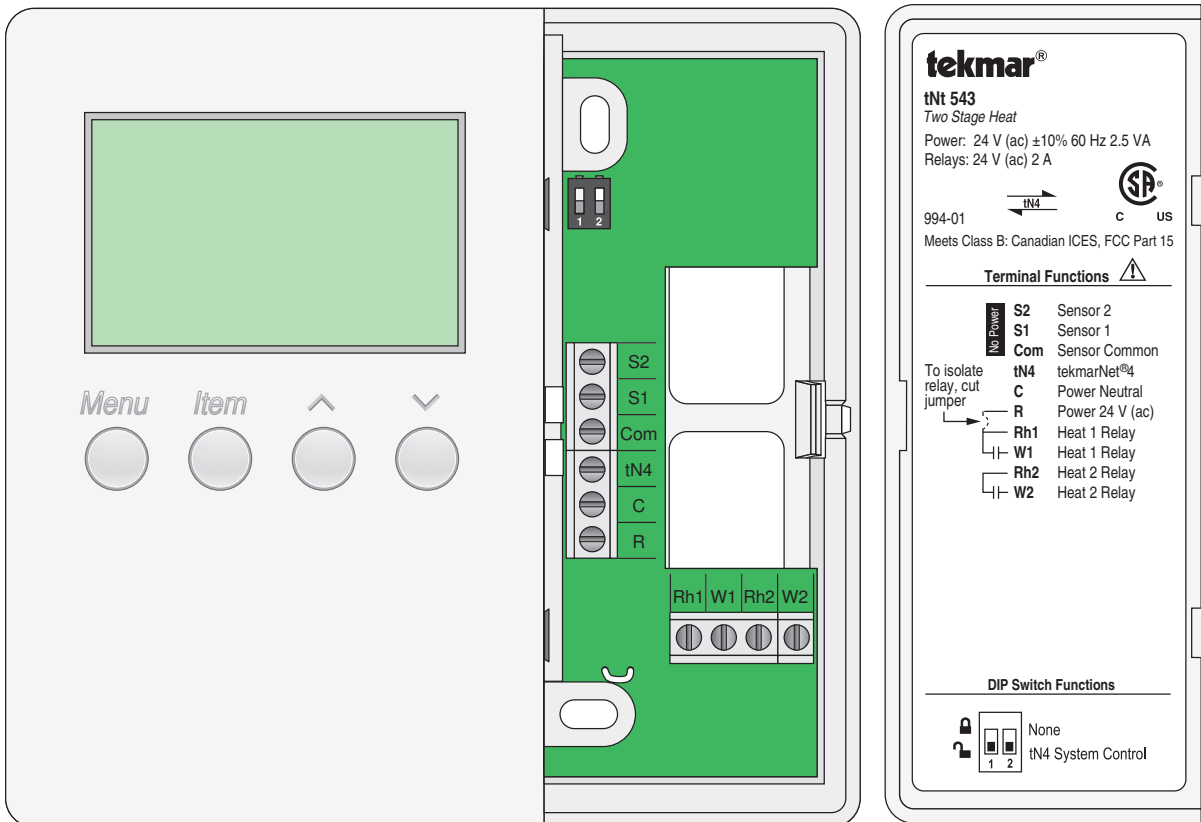

Table of Contents

Table of Contents.....	2	Cycles Per Hour	18
Display and DIP Switches	2	Heating Terminal Units	20
Dip Switches	2	Heating Operation	21
Access Levels	3	Cool Groups	23
Display and Symbols Description.....	3	Time Clock.....	23
User Interface	4	Setting the Schedule.....	24
Setup	5	Optimum Start / Stop	25
View Menu	5	Scenes	25
Adjust Menu	6	Away Hold	27
Time Menu.....	10	Offset	27
Scene Menu.....	11	Units of Temperature	27
Schedule Menu	12	Backlight	27
Miscellaneous Menu	15	tN4 Address	27
Thermostat Operation	17	Pump Exercising	27
Auxiliary Sensors	17	Error Messages	28
Mode of Operation	17	Cleaning the Thermostat	31
Adjusting the Temperature	18	Warranty	32

Display and DIP Switches

Dip Switches

tN4 System Control (DIP Switch #2)

A tN4 System Control is a control, not a thermostat, that the 543 thermostat connects to through the tN4 bus. All tN4 compatible Outdoor Reset Modules are tN4 System Controls.

- If the thermostat is connected to a tN4 System Control, set the tN4 System Control DIP switch to tN4 System Control (down position).
- If the thermostat is not connected to a tN4 System Control, set the tN4 System Control DIP switch to None (up position).

Lock / Unlock (DIP Switch #1)

Use the Lock/Unlock DIP switch to lock or unlock the Access Level of the 543.

- To unlock the Access Level, set the DIP switch to the unlocked (down) position.
- To lock the Access Level, set the DIP switch to the locked (up) position. Once locked, a padlock is displayed in the lower right corner of the display and the Access Level cannot be changed.

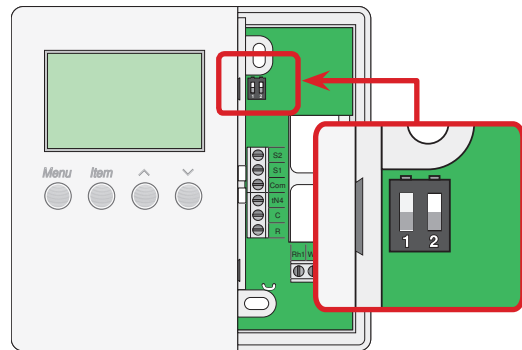

Note: The tN4 System Control's Lock/Unlock DIP switch overrides the Lock/Unlock DIP switch on the 543. Set the tN4 System Control's Lock/Unlock DIP switch to the Unlock position before Access Levels can be changed on the thermostat.

Access Levels

The Access Level restricts the number of Menus, Items and Adjustments that can be accessed by the user. The Access Level setting is found in the Miscellaneous (MISC) menu. Select the appropriate access level for the people who work with the thermostat on a regular basis.

The 543 has five Access Levels:

- Advanced (ADV): access to all settings
- Installer (INST): settings required for installation
- User (USER): for property owners
- Limited (LTD): limited temperature adjustment
- Secure (SEC): for commercial and public installations

For more information, see the Misc (Miscellaneous) Menu section.

In the following menu tables, the access level the item is visible in is shown in the access column.





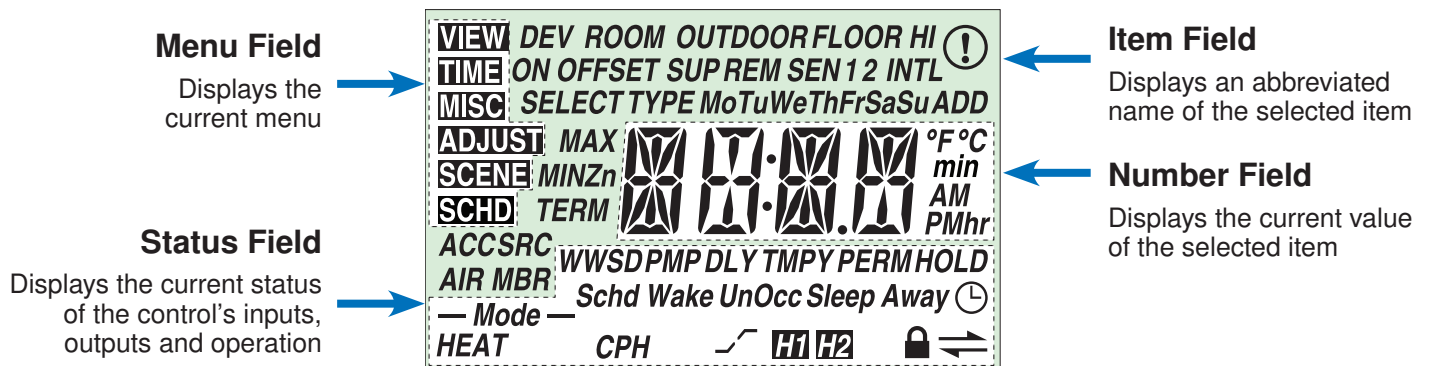

To adjust the Access Level:

1. Set the Unlock/Lock DIP switch to the unlock position. If a tN4 System Control is connected to the 543, the Unlock/Lock DIP switch on the tN4 System Control must be set to the unlock position.
2. Use the Menu button to select the Misc menu.
3. Use the Item button to select the Access menu item.
4. Use the Up and Down button to select the required Access Level.

Display



Symbols Description

— Mode — HEAT	MODE OF OPERATION Displays whether the device is in heating or off mode.		LOCK The Access Levels are locked. A menu option is visible but not adjustable.
	FIRST STAGE HEAT First stage heating is operating.		OPTIMUM START / STOP The Optimum Start or Optimum Stop feature is active.
	SECOND STAGE HEAT Second stage heating is operating.		WARNING An error is present.
	SCHEDULE MASTER Indicates that this thermostat is a schedule master.	TMPY HOLD	TEMPORARY HOLD The temperature has been temporarily adjusted from the scheduled event.
	tN4 COMMUNICATION A tN4 network is detected.	Wake UnOcc Sleep Away	SCHEDULED EVENT Displays the current scheduled event.

User Interface

Use the User Interface available on the Liquid Crystal Display (LCD) to setup and monitor the operation of the thermostat. Use the four push buttons below the LCD (Menu, Item, Up, Down) to select settings. As you enter settings, record the settings in the Job Record J543.

Menu

The menus display in the Menu Field at the left of the LCD.

Six menus are available:

- View
- Adjust
- Time
- Scene
- Schedule
- Miscellaneous

To select a menu, press and release the Menu button.

Item

In each menu, a group of items can be selected. The abbreviated name of the selected item displays in the Item field of the LCD display.

- To view the next available item, press and release the Item button.
- To view the previous item, hold down the Item button and press and release the Up button.

Adjusting a Setting

To adjust a setting:

1. Use the Menu button to select the appropriate menu.
2. Use the Item button to select a menu item.
3. Use the Up or Down button to adjust the setting.

Default Item

- To set the default item in the View Menu, display the item for more than five seconds.

After navigating menus, the display reverts back to the default item after 60 seconds of button inactivity.

Copy Settings

To save time in setting thermostats, you can copy the settings from one tN4 thermostat to a second tN4 thermostat.

Refer to the COPY item in the Misc menu on page 16.

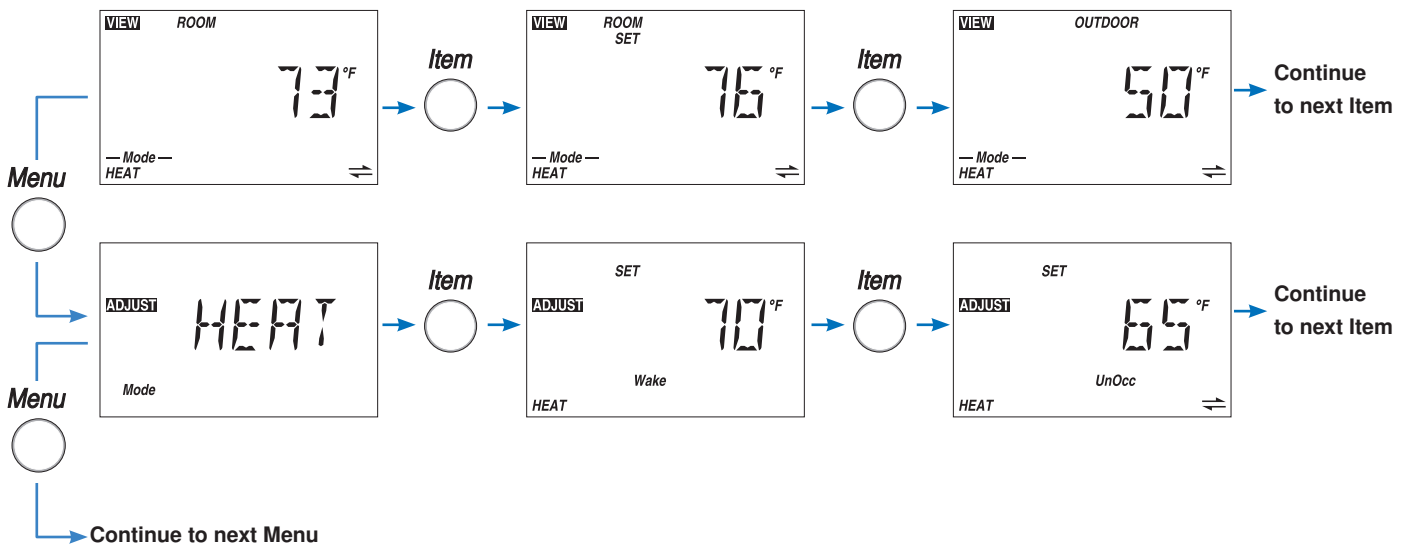

Display Menus

View Menu (1 of 2)

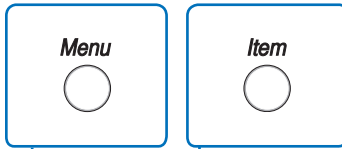

The View menu items display the current operating temperatures and status information of the system.

VIEW MENU

Item Field	Range	Access	Description
	-58 to 212°F (-50.0 to 100.0°C)	SEC LTD USER INST ADV	ROOM SECTION A Current air temperature in the room. Note: This item is only available when the Room Sensor is set to On or Sensor 1 or 2 is set to Room.
	---, 40 to 95°F (---, 4.5 to 35.0°C)	USER INST ADV	ROOM SET SECTION A Selected room temperature. Note: This item is only available when the Room Sensor is set to On or Sensor 1 or 2 is set to Room.
	--- (if no recent message), -58 to 212°F (-50.0 to 100.0°C)	SEC LTD USER INST ADV	OUTDOOR SECTION A Current temperature at the outdoor sensor. Note: This item is only available when an outdoor sensor is connected to the tN4 network.
	-76 to 149°F (-60.0 to 65.0°C)	USER INST ADV	OUTDOOR HIGH SECTION A Records the highest outdoor temperature. Press Up and Down buttons to clear. Note: This item is only available when an outdoor sensor is connected to the tN4 network.
	-76 to 149°F (-60.0 to 65.0°C)	USER INST ADV	OUTDOOR LOW SECTION A Records the lowest outdoor temperature. Press Up and Down buttons to clear. Note: This item is only available when an outdoor sensor is connected to the tN4 network.
	-58 to 212°F (-50.0 to 100.0°C)	SEC LTD USER INST ADV	FLOOR SECTION A Current floor temperature. Note: This item is only available when Sensor 1 or 2 is set to Floor.
	-58 to 212°F (-50.0 to 100.0°C)	USER INST ADV	REMOTE SENSOR SECTION A Current temperature at the remote sensor location. Note: This item is only available when Sensor 1 is set to Remote.

Continued on next page.

View Menu (2 of 2)

VIEW MENU

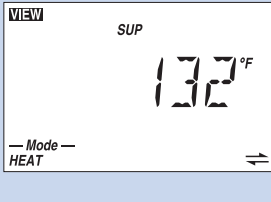
Item Field	Range	Access	Description
	-22 to 266 °F (-30.0 to 130.0 °C)	INST ADV	SUPPLY TEMPERATURE OF TN4 BUS SECTION F Actual water temperature of the tN4 bus for the first stage of heat. Note: This item is only available when the thermostat is connected to an Outdoor Reset Module and the DIP switch is set to tN4 System Control.

After the last item, the control returns to the first item in the menu.

Adjust Menu (1 of 4)

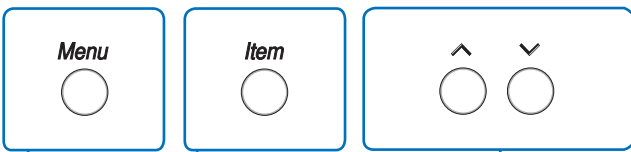

The Adjust Menu items are the programmable settings used to operate the mechanical equipment.

ADJUST MENU

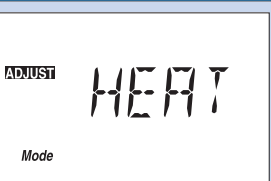
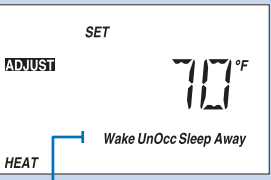
Item Field	Range	Access	Description
	OFF, HEAT, Default = HEAT	USER INST ADV	MODE OF OPERATION SECTION B Mode of operation of the thermostat.
	40 to 95 °F (4.5 to 35.0 °C)	LTD USER INST ADV	SET HEAT SECTION C Selected air heating temperature for each event. Note: At the Limited Access Level, you can only adjust the temperature +/-3 °F (1.5 °C) from the last setting. Away is only available when Scenes are turned on.
Wake	Default = 70 °F (21.0 °C)		
UnOccupied	Default = 62 °F (16.5 °C)		
Occupied	Default = 70 °F (21.0 °C)		
Sleep	Default = 62 °F (16.5 °C)		
Away	Default = 62 °F (16.5 °C)		

Continued on next page.

Adjust Menu (2 of 4)





ADJUST MENU

Item Field	Range	Access	Description
<p>FLOOR</p> <p>ADJUST MIN 70°F</p> <p>Wake UnOcc Sleep Away</p>	<p>OFF, 40 to 122°F (OFF, 4.5 to 50.0°C)</p>	<p>LTD USER INST ADV</p>	<p>FLOOR MINIMUM SECTION A</p> <p>Select the minimum floor temperature for each event.</p> <p>Note: This item is only available when Sensor 1 or 2 is set to Floor. At the Limited Access Level, you can only adjust the temperature +/-3°F (1.5°C) from the last setting.</p>
<p>Wake</p>	<p>Default = 70°F (21.0°C)</p>		
<p>UnOccupied</p>	<p>Default = OFF</p>		
<p>Occupied</p>	<p>Default = 70°F (21.0°C)</p>		
<p>Sleep</p>	<p>Default = OFF</p>		
<p>FLOOR</p> <p>ADJUST MAX 85°F</p>	<p>40 to 122°F (4.5 to 50.0°C) Default = 85°F (29.5°C)</p>	<p>ADV</p>	<p>FLOOR MAXIMUM SECTION A</p> <p>Maximum floor temperature.</p> <p>Note: This item is only available when Sensor 1 or 2 is set to Floor.</p>
<p>SEN 1</p> <p>ADJUST OFF</p>	<p>OFF, ROOM, FLOR (Floor), REM (Remote) Default = OFF</p>	<p>INST ADV</p>	<p>SENSOR 1 SECTION A</p> <p>Select the type of sensor connected to the auxiliary sensor input 1.</p>
<p>SEN 2</p> <p>ADJUST OFF</p>	<p>OFF, ROOM, FLOR (Floor), OUT (Outdoor) Default = OFF</p>	<p>INST ADV</p>	<p>SENSOR 2 SECTION A</p> <p>Select the type of sensor connected to auxiliary sensor input 2.</p>
<p>ROOM SEN</p> <p>ADJUST ON</p>	<p>OFF, ON Default = ON</p>	<p>INST ADV</p>	<p>ROOM SENSOR SECTION A</p> <p>Selects whether the built-in room sensor is functional.</p>
<p>ADJUST AUTO</p> <p>HEAT CPH</p>	<p>SYNC, AUTO 2 to 12 Default = AUTO</p>	<p>ADV</p>	<p>HEAT CYCLES PER HOUR SECTION D</p> <p>Select the number of heating cycles per hour. SYNC results in 5 CPH. All tN4 thermostats that are connected and have the SYNC setting selected synchronize their cycle to the same starting time.</p> <p>Note: This item is only available when the tN4 System Control DIP switch is set to None.</p>
<p>ADJUST CTRL</p> <p>TERM</p>	<p>CTRL, HRF1, HRF2, COIL, CONV, RAD, BASE, OTHR Default =CTRL</p>	<p>INST ADV</p>	<p>HEAT 1 TERMINAL SECTION E</p> <p>Select the type of heating terminal.</p> <p>Note: If CTRL is selected, the terminal unit selected on the tN4 System Control is used.</p>

Continued on next page.

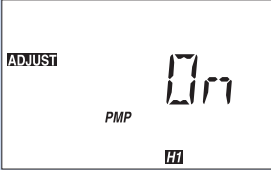
Adjust Menu (3 of 4)

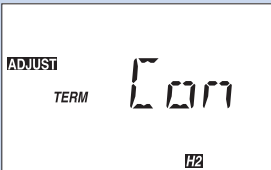
ADJUST MENU

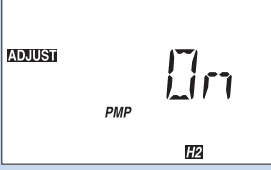
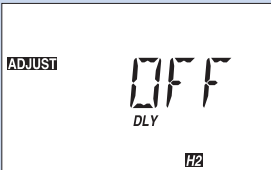
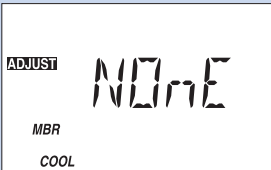
Item Field	Range	Access	Description
	OFF, ON Default = ON	INST ADV	HEAT 1 PUMP SECTION F Select whether the system, primary, or mixing pump on a tN4 System Control must operate while the heat is operating. Note: This item is only available when the H1 Terminal item is set to CTRL, HRF1, HRF2, Fan Coil, Convector, Radiator, or Baseboard.
	OFF, ON Default = OFF	INST ADV	HEAT 1 DELAY SECTION F Select whether the system, primary, or mixing pump on a tN4 System Control is delayed to allow a thermal motor zone valve to open. Select On for thermal motor, select Off for zone pump or motorized zone valve. Note: This item is only available when the H1 Terminal item is set to CTRL, HRF1, HRF2, Fan Coil, Convector, Radiator, or Baseboard.
	None, CTRL, HrF1, HrF2, COIL, Con, RAD, bASE, OTHr Default = CON	INST ADV	HEAT 2 TERMINAL SECTION E Select the type of heating terminal for second stage heat. If NONE is selected, the second stage heat is disabled. Note: If CTRL is selected, the terminal unit selected on the tN4 System Control is used.
	BOIL, MIX1, MIX2, MIX3 Default = BOIL	ADV	HEAT 2 SOURCE SECTION F Select the tN4 bus on which the second stage heat zone operates. This setting determines water temperature and system pump operation. Note: This item is only available when the H2 Terminal item is set to CTRL, HRF1, HRF2, Fan Coil, Convector, Radiator, or Baseboard.
	OFF, ON Default = ON	INST ADV	HEAT 2 PUMP SECTION F Select whether the system, primary, or mixing pump on a tN4 System Control must operate while the second stage heat is operating. Note: This item is only available when the H2 Terminal item is set to CTRL, HRF1, HRF2, Fan Coil, Convector, Radiator, or Baseboard.
	OFF, ON Default = OFF	INST ADV	HEAT 2 DELAY SECTION F Select whether the system, primary, or mixing pump on a tN4 System Control is delayed to allow a second stage heat thermal motor zone valve to open. Select On for thermal motor, select Off for zone pump or motorized zone valve. Note: This item is only available when the H2 Terminal item is set to CTRL, HRF1, HRF2, Fan Coil, Convector, Radiator, or Baseboard.
	NONE, 1 to 16 Default = NONE	ADV	COOL MEMBER SECTION G Select the cool group of which this thermostat is a member. Select None if this thermostat is not a cool group member. Note: This item is only available when the thermostat is connected to a tN4 network.

Continued on next page.

Adjust Menu (4 of 4)

ADJUST MENU

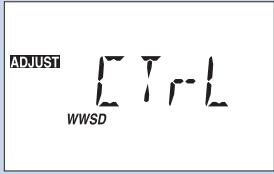
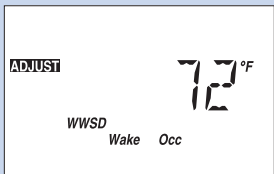
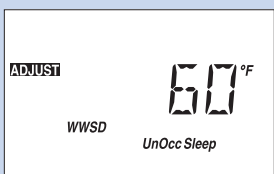
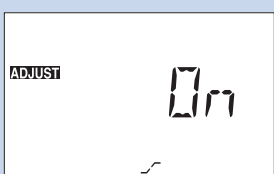
Item Field	Range	Access	Description
 <p>ADJUST WWSDD CTRL</p>	<p>NONE, ZONE, CTRL Default = CTRL</p>	<p>ADV</p>	<p>WARM WEATHER SHUT DOWN SECTION N Set the outdoor temperature at which warm weather shutdown occurs. Select whether the thermostat follows the tN4 System Control's or the zone's WWSDD for scheduled events.</p>
 <p>ADJUST WWSDD Wake Occ 72°F</p>	<p>40 to 100°F, OFF (4.5 to 38.0°C, OFF) Default = 72°F (22.0°C)</p>	<p>INST ADV</p>	<p>WWSDD OCCUPIED AND WAKE SECTION N Set the Warm Weather Shut Down (WWSDD) temperature during Occupied and Wake events. Note: This item is only available when WWSDD is set to Zone.</p>
 <p>ADJUST WWSDD UnOcc Sleep 60°F</p>	<p>40 to 100°F, OFF (4.5 to 38.0°C, OFF) Default = 60°F (15.5°C)</p>	<p>INST ADV</p>	<p>WWSDD UNOCCUPIED AND SLEEP SECTION N Set the Warm Weather Shut Down temperature during Unoccupied and Sleep events. Note: This item is only available when WWSDD is set to Zone.</p>
 <p>ADJUST On</p>	<p>ON, OFF Default = ON</p>	<p>INST ADV</p>	<p>OPTIMUM START / STOP SECTION J Select whether to use Optimum Start/Stop for heating. Note: This item is only available when a heating schedule is selected.</p>

- After the last item, the control returns to the first item in the menu.

Time Menu (1 of 1)



TIME MENU

Item Field	Range	Access	Description
	SUNDAY, MONDAY, TUESDAY, WEDNESDAY, THURSDAY, FRIDAY, SATURDAY Default = MONDAY	USER INST ADV	CURRENT TIME AND DAY SECTION H Displays the current time and day of the week. The time and date flash if the time is not set.
	12:00 to :59 Default = :12:00 AM	USER INST ADV	CLOCK MINUTES SECTION H Set the minutes.
	12:00 AM to 11:59 PM or 00:00 to 23:59 Default = 12:00 AM	USER INST ADV	CLOCK HOURS SECTION H Set the hours.
	SUNDAY ... WEDNESDAY ... SATURDAY Default = SUNDAY	USER INST ADV	DAY OF THE WEEK SECTION H Set the day of the week.
	12 hr to 24 hr Default = 12	ADV	MODE SECTION H Select whether time should be displayed using a 12 or a 24 hour clock.

• After the last item, the control returns to the first item in the menu.

Scene Menu (1 of 2)

Menu



Item

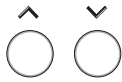

The Scene Menu items set the current scene as well as the scene settings.

SCENE MENU

Item Field	Range	Access	Description
	Occ, Away PERM1, PERM Away 2 PERM UnOcc 3, PERM 4, PERM5 TMPY Occ 6 TMPY 7, TMPY 8 Default = Occ PERM 1	USER INST ADV	SELECT SECTION K Select the scene for the building. Note: Only Occ and AWAY are available when no schedule is selected.
	INF, 1 to 180 days Default = INF	USER INST ADV	AWAY HOLD SECTION K Set the number of days for the Permanent Away 2 scene. When the scene is selected, the thermostat remains in that scene for the set number of days then reverts to the last permanent scene.
	Schd Wake Occ UnOcc Sleep Away Default = SCHD	INST ADV	SET PERMANENT 1 SECTION K Select an action for the Permanent 1 scene. Note: This item is only available when SCENE menu is set to ON and a schedule has been selected.
	Schd Wake Occ UnOcc Sleep Away Default = SCHD	INST ADV	SET PERMANENT 4 SECTION K Select an action for the Permanent 4 scene. Note: This item is only available when SCENE menu is set to ON and a schedule has been selected.
	Schd Wake Occ UnOcc Sleep Away Default = SCHD	INST ADV	SET PERMANENT 5 SECTION K Select an action for the Permanent 5 scene. Note: This item is only available when SCENE menu is set to ON and a schedule has been selected.
	Schd Wake Occ UnOcc Sleep Away Default = SCHD	INST ADV	SET TEMPORARY 7 SECTION K Select an action for the Temporary 7 scene. The scene lasts for 4 hours before reverting to the previous permanent scene. Note: This item is only available when SCENE menu is set to ON and a schedule has been selected.
	Schd Wake Occ UnOcc Sleep Away Default = SCHD	INST ADV	SET TEMPORARY 8 SECTION K Select an action for the Temporary 8 scene. The scene lasts for 8 hours before reverting to the previous permanent scene. Note: This item is only available when SCENE menu is set to ON and a schedule has been selected.

Continued on next page.

Scene Menu (2 of 2)

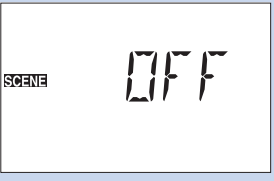
Item Field	Range	Access	Description
	1:00 to 10:00 hr (½ hr intervals) Default = 3:00	USER INST ADV	TEMPORARY ZONE HOLD SECTION C Select the number of hours the temporary hold affects this zone.
	OFF, ON Default = OFF	INST ADV	SCENE MENU SECTION K Select the Scene feature of the thermostat.

After the last item, the control returns to the first item in the menu.

Schedule Menu (1 of 4)

Menu
○

Item
○

^
○ ○
v

The Schedule menu items set the schedule type, the number of events per day, and the event times.

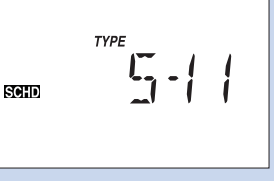
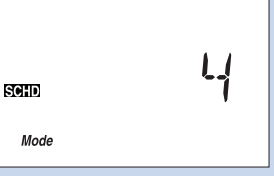
Item Field	Range	Access	Description
	NONE, ZONE, MST1, MST2, MST3, MST4, MBR1, MBR2, MBR3, MBR4 Default = NONE	USER INST ADV	HEAT SCHEDULE SECTION I If a schedule is not required, select NONE. If the schedule is only used by this thermostat, select ZONE. If the schedule is shared with other thermostats, select MST1 to MST4. If the schedule is set on another thermostat, select MBR1 to MBR4. Note: This item can be viewed in the USER and INST access levels but can only be adjusted in the ADV access level.
	24 hr, 5-2, 5-11, 7dAY Default = 5-11	USER INST ADV	SCHEDULE TYPE SECTION I Select the type of schedule. Note: This item is only available when the Heat Schedule is set to ZONE or MST1 to MST4.
	2 (Occ, UnOcc), 4 (Wake, UnOcc, Occ, Sleep) Default = 4	USER INST ADV	SCHEDULE MODE SECTION I Select the number of events per day. Note: This item is only available when the Heat Schedule is set to ZONE or MST1 to MST4.

Continued on next page.

Schedule Menu (2 of 4)

Item Field	Range	Access	Description
	--:-- to 11:50 PM or --:-- to 23:50	USER INST ADV	ALL DAYS OF THE WEEK SECTION I Select the times for the scheduled events. Note: This item is only available when the Schedule Type is set to 24 hr.
Wake	Default = 6:00 AM		
UnOccupied	Default = 8:00 AM		
Occupied	Default = 6:00 PM		
Sleep	Default = 10:00 PM		
	--:-- to 11:50 PM or --:-- to 23:50	USER Inst Adv	MONDAY THROUGH FRIDAY SECTION I Select the time for the scheduled events. Note: This item is only available when the Heat or Cool Schedule is set to Zone, to a Schedule Master and Schedule Type is set to 5-2 or 5-11.
Wake	Default = 6:00 AM		
UnOccupied	Default = 8:00AM		
Occupied	Default = 6:00 PM		
Sleep	Default = 10:00 PM		
	--:-- to 11:50 PM or --:-- to 23:50	USER INST ADV	SATURDAY AND SUNDAY SECTION I Select the times for the scheduled events. Note: This item is only available when the Schedule Type is set to 5-2.
Wake	Default = 6:00 AM		
UnOccupied	Default = 8:00 AM		
Occupied	Default = 6:00 PM		
Sleep	Default = 10:00 PM		
	--:-- to 11:50 PM or --:-- to 23:50	USER INST ADV	SATURDAY SECTION I Select the times for the scheduled events. Note: This item is only available when the Schedule Type is set to 5-11 or 7dAY.
Wake	Default = 6:00 AM		
UnOccupied	Default = 8:00 AM		
Occupied	Default = 6:00 PM		
Sleep	Default = 10:00 PM		

SCHEDULE MENU

Continued on next page.

Schedule Menu (3 of 4)

SCHEDULE MENU

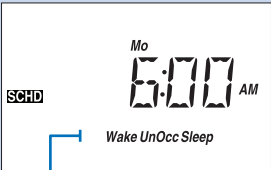
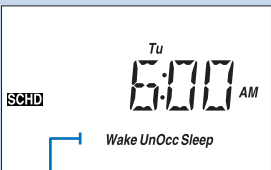
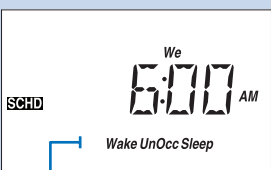
Item Field	Range	Access	Description
	--:-- to 11:50 PM or --:-- to 23:5	USER INST ADV	SUNDAY SECTION I Select the times for the scheduled events. Note: This item is only available when the Schedule Type is set to 5-11 or 7dAY.
Wake	Default = 6:00 AM		
UnOccupied	Default = 8:00 AM		
Occupied	Default = 6:00 PM		
Sleep	Default = 10:00 PM		
	--:-- to 11:50 PM or --:-- to 23:50	USER INST ADV	MONDAY SECTION I Select the times for the scheduled events. Note: This item is only available when the Schedule Type is set to 7dAY.
Wake	Default = 6:00 AM		
UnOccupied	Default = 8:00 AM		
Occupied	Default = 6:00 PM		
Sleep	Default = 10:00 PM		
	--:-- to 11:50 PM or --:-- to 23:50	USER INST ADV	TUESDAY SECTION I Select the times for the scheduled events. Note: This item is only available when the Schedule Type is set to 7dAY.
Wake	Default = 6:00 AM		
UnOccupied	Default = 8:00 AM		
Occupied	Default = 6:00 PM		
Sleep	Default = 10:00 PM		
	--:-- to 11:50 PM or --:-- to 23:50	USER INST ADV	WEDNESDAY SECTION I Select the times for the scheduled events. Note: This item is only available when the Schedule Type is set to 7dAY.
Wake	Default = 6:00 AM		
UnOccupied	Default = 8:00 AM		
Occupied	Default = 6:00 PM		
Sleep	Default = 10:00 PM		

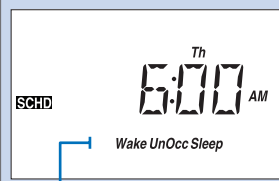
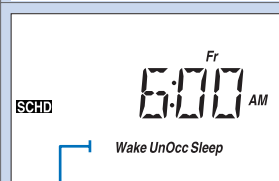

Continued on next page.

Schedule Menu (4 of 4)

Item Field	Range	Access	Description
	--:-- to 11:50 PM or --:-- to 23:50	USER INST ADV	THURSDAY SECTION I Select the times for the scheduled events. Note: This item is only available when the Schedule Type is set to 7dAY.
Wake	Default = 6:00 AM		
UnOccupied	Default = 8:00 AM		
Occupied	Default = 6:00 PM		
Sleep	Default = 10:00 PM		
	--:-- to 11:50 PM or --:-- to 23:50	USER INST ADV	FRIDAY SECTION I Select the times for the scheduled events. Note: This item is only available when the Schedule Type is set to 7dAY.
Wake	Default = 6:00 AM		
UnOccupied	Default = 8:00 AM		
Occupied	Default = 6:00 PM		
Sleep	Default = 10:00 PM		



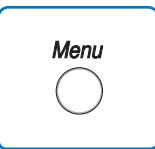
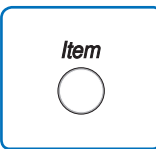
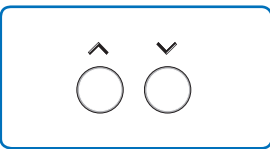



• After the last item, the control returns to the first item in the menu.

Misc (Miscellaneous) Menu (1 of 2)

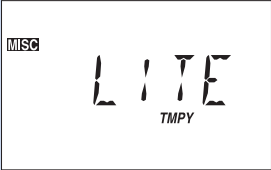
			<div style="border: 1px solid black; padding: 5px;"> The Miscellaneous menu items set display and control options such as access level and temperature units. </div>
Item Field	Range	Access	Description
	SEC, LTD, USER, INST, ADV Default = USER	SEC LTD USER INST ADV	ACCESS LEVEL The access level of the thermostat. The access column shows which items are visible in each access level. Note: This item is only available when the Lock/Unlock DIP switch on the thermostat and the tN4 system control are set to Unlock.
	°F, °C Default = °F	USER INST ADV	UNITS SECTION O Select Fahrenheit or Celsius as the temperature units.

• Continued on next page.

Misc (Miscellaneous) Menu (2 of 2)

Item Field	Range	Access	Description
	ON, TMPY, OFF Default = TMPY	USER INST ADV	BACKLIGHT SECTION P Select whether the backlight displays permanently, temporarily, or is off. The temporary backlight lasts for 30 seconds.
	-5.0 to +5.0°F in 0.1°F increments (-3.0° to +3.0°C in 0.1°C increments) Default = 0.0°F	ADV	OFFSET SECTION M Fine tune the current room temperature. Adjustments are in tenths of a degree.
	---, -bus#:01, ... bus#:24, DEF Default = ---	INST ADV	COPY SETTINGS Copy settings from another thermostat to this thermostat. <ol style="list-style-type: none"> 1. Select the address of the thermostat to copy from. Select DEF to load the factory default settings. 2. Wait for 3 seconds and then press the Up and Down buttons for 1 second. 3. The thermostat will show the percentage of progress. 4. Displays DONE if successful or WARN if only part of the settings were copied.
	1 to 24	ADV	NUMBER OF DEVICES Number of tN4 devices connected to this tN4 bus. Note: This item is only available when the thermostat is connected to a tN4 bus.
	AUTO, -bus#:01, ... bus#:24 Default = AUTO	SEC LTD USER INST ADV	ADDRESS SECTION Q The tN4 bus address of this thermostat. Auto allows the tN4 system to automatically assign an address to the thermostat. To manually set the address, use the Up or Down buttons while in the ADV or INST access level. Note: This item is only available when the thermostat is connected to a tN4 bus.
	543, Software Version	SEC LTD USER INST ADV	TYPE Product number of this thermostat. Hold the Up button to view the software version.

MISC MENU

After the last item, the control returns to the first item in the menu.

Thermostat Operation

Auxiliary Sensors

Section A

The thermostat has a built-in sensor to measure air temperature at the thermostat. In addition to the built-in sensor, the thermostat has terminals to connect up to two separate auxiliary sensor. This sensor can either be room sensors, floor sensors, a remote sensor, or an outdoor sensor.

If the auxiliary sensor is installed, you must make the appropriate sensor input setting before the thermostat will recognize the sensor.

- Locate the Sensor 1 and 2 settings in the Adjust menu.

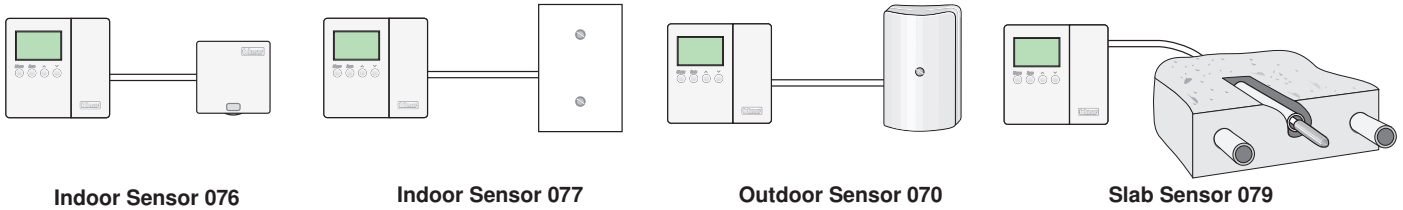

Room Sensor

A room sensor measures the air temperature in the zone that the thermostat controls. This measurement is used to calculate on times for heating and cooling operations. Up to two auxiliary sensor inputs can be configured for a room sensor. If additional room sensors are installed, the thermostat averages the room sensor readings and uses the average as the current room temperature.

If a built-in sensor reading is not required, the built-in sensor can be turned off. This removes the built-in sensor from the temperature average.

Floor Sensor

A floor sensor measures floor temperature in the zone that the thermostat controls. Floor temperature operates in a range between the Floor Minimum and Floor Maximum settings.

- Locate the Floor Minimum and the Floor Maximum settings in the Adjust Menu.

Remote Sensor

A single remote sensor can be connected to the thermostat. The temperature measured by a remote sensor does not affect the heating and cooling operation and is only used for display purposes.

- Locate the Remote sensor under the Sensor 1 item in the Adjust menu.

Outdoor Sensor

An outdoor sensor can be connected to the thermostat. The temperature measured by an outdoor sensor is displayed on the thermostat. The thermostat communicates the outdoor temperature to all other devices on the tN4 network.

- Locate the Outdoor sensor under the Sensor item in the Adjust menu.

Mode of Operation

Section B

You can operate the thermostat in either the heating or off modes by manually setting the Mode item to Heat or Off. The Mode item is found in the Adjust menu. When Mode is set to Off, the thermostat does not operate except to provide freeze protection.

- Locate the Mode item in the Adjust menu.

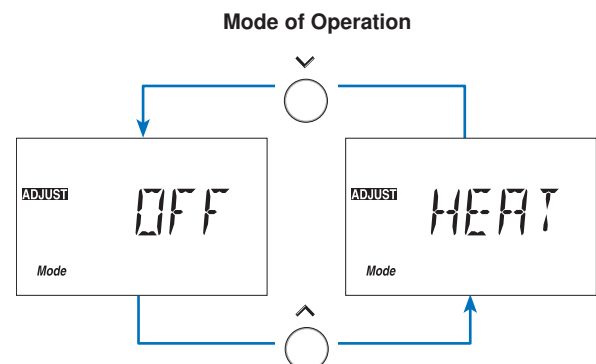

Adjusting the Room Set Temperature (No Schedule)

Section C1

If no schedule is being used, the heating temperature can be permanently adjusted from the View menu when viewing either the “Room” or “Room Set” items.

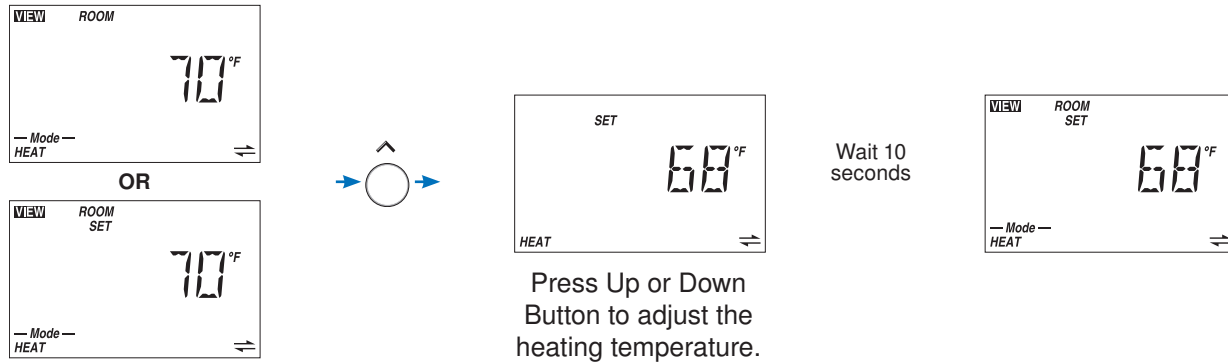

Adjusting the Room Set Temperature (Schedule)

Section C2

When using a schedule, the heating temperature for each schedule event can be permanently changed from the Adjust menu. There will be one “Set Heat” item in the Adjust menu for each scheduled event.

In a two event schedule, the events are:

- Occ (Occupied)
- UnOcc (UnOccupied)

In a four event schedule, the events are:

- Wake
- UnOcc
- Occ
- Sleep

When scenes are used, an additional ‘Away’ event is available.

If a schedule is not in use, only the Set Heat Occ setting is available.

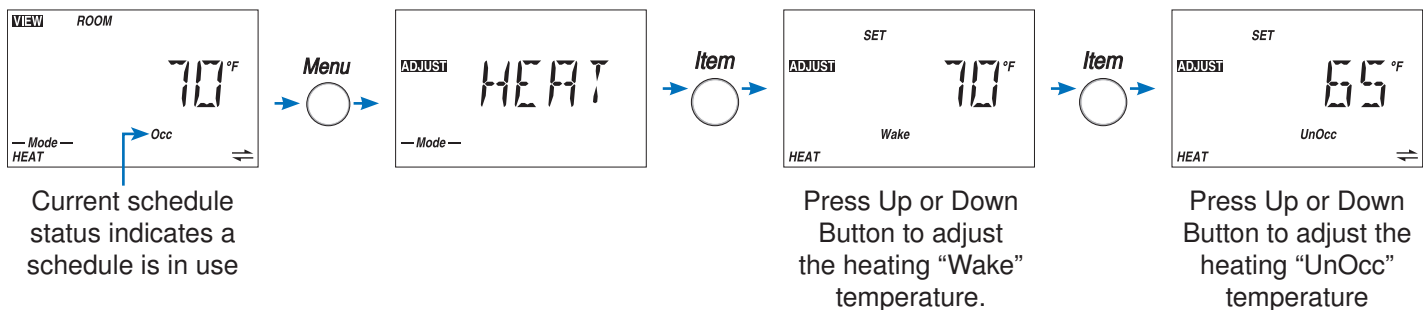

Pressing the up or down button while viewing the Room or Room Set temperature during scheduled operation allows for a temporary change in temperature. When the temporary change is in effect, the words “TMPY HOLD” are shown on screen.

By default, the temporary change lasts for 3 hours. This duration can be changed by going to the “Temporary Zone Hold” item in the Scene menu.

The temporary change can be cancelled before it expires by pressing the Up and Down buttons at the same time.

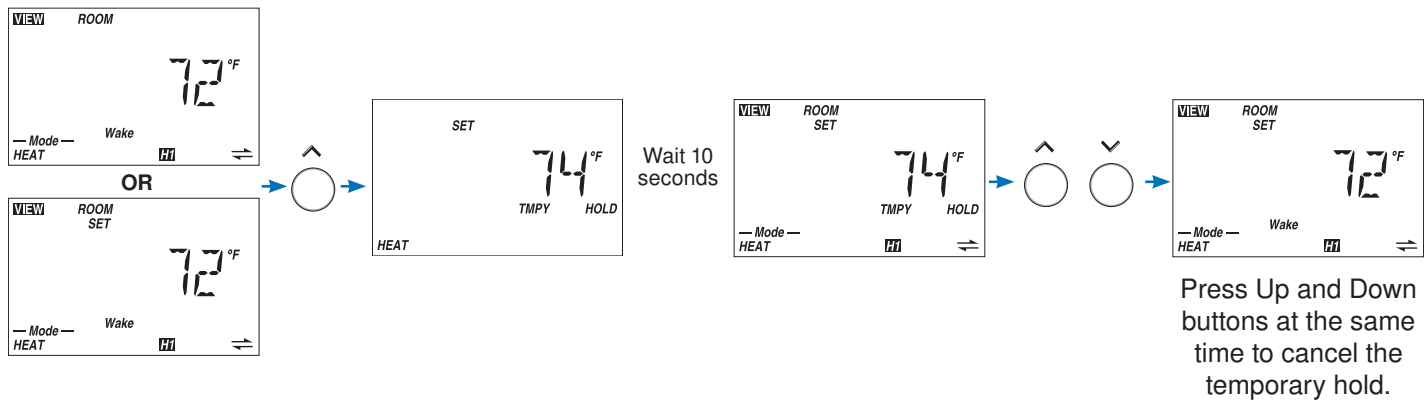

Cycles Per Hour

Section D

You can set the number cycles per hour (CPH) for the heating operation. The default setting for heating cycles per hour is automatic.

Heating CPH:

- When the thermostat is connected to a tN4 System Control, the thermostat uses the CPH setting on the tN4 System Control for the Heating CPH.
- To manually set the cycles per hour when the thermostat is not connected to a tN4 System Control, go to the Adjust menu and select the Heat CPH item.
- When the thermostat is connected to a tN4 system with only thermostats, the SYNC setting synchronizes the operation of all the thermostats to 5 CPH.

This thermostat supports Outdoor Reset characterized heating curves when used in hydronic heating systems. By setting the correct terminal unit setting, the thermostat can improve the operation of the heating system. Each stage of heat has its own terminal unit setting.

Control (CTRL)

Selecting Control as the terminal unit setting on the thermostat causes the thermostat to adopt the tN4 System Control's terminal unit setting.

Hydronic Radiant Floor 1 (HRF1)

Terminal type for a heavy, or high mass, hydronic radiant floor system. This type of a hydronic radiant floor is embedded in either a thick concrete or gypsum pour. This heating system has a large thermal mass and is slow acting.

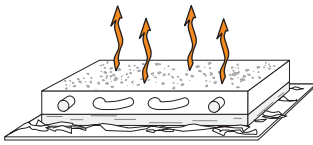

Hydronic Radiant Floor 2 (HRF2)

Terminal type for a light, or low mass, hydronic radiant floor system. Most commonly, this type of radiant heating system is either attached to the bottom of a wood sub floor, suspended in the joist space, or sandwiched between the subfloor and the surface. This type of radiant system has a relatively low thermal mass and responds faster than a high mass system.

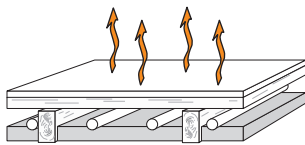

Fancoil (COIL)

A fancoil terminal unit or air handling unit (AHU) consists of an hydronic heating coil and either a fan or blower. Air is forced across the coil at a constant velocity by the fan or blower and is then delivered into the building space.

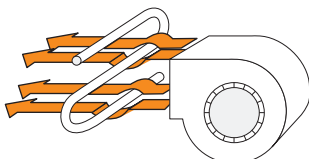

Fin-tube Convector (CONV)

A convector terminal unit is made up of a heating element with fins on it. This type of terminal unit relies on the natural convection of air across the heating element to deliver heated air into the space. The amount of natural convection is dependant on the supply water temperature to the heating element and the room air temperature.

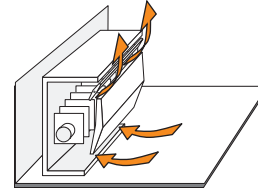

Radiator (RAD)

A radiator terminal unit has a large heated surface that is exposed to the room. A radiator provides heat to the room through radiant heat transfer and natural convection.

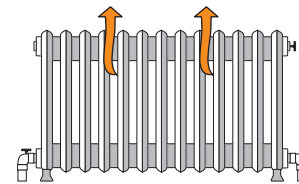

Baseboard (BASE)

A baseboard terminal unit is similar to a radiator, but has a low profile and is installed at the base of the wall. The proportion of heat transferred by radiation from a baseboard is greater than that from a fin-tube convector.

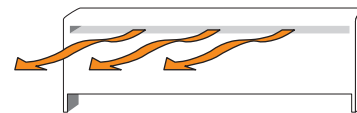

Other (OTHR)

In applications where a non-hydronic heating system (furnace, electric baseboard, etc.) is installed, set the terminal unit to other.

Indoor Temperature Feedback

Indoor feedback applies when the thermostat is connected to a tN4 network with a tN4 System Control. Indoor temperature feedback fine tunes the water temperature of the system based on the requirements of the thermostats.

Each thermostat tells the tN4 System Control the water temperature that it requires to heat its zone.

- If the zone is becoming too cool, the thermostat asks for a higher water temperature.
- If the zone is becoming too warm, the thermostat asks for a cooler water temperature.

The tN4 System Control provides the highest water temperature required by all of the thermostats.

- The thermostat with the highest water temperature requirement stays on 100% of its cycle.
- The remaining thermostats stay on for a percentage of their cycles.

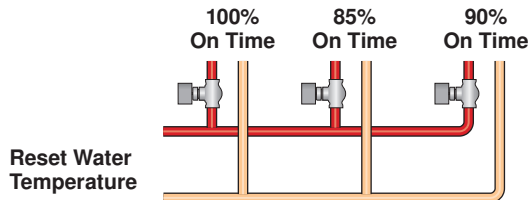

One Stage Heating

Room Sensor Only

When operating with only an room sensor, the on time for the Heat relay is calculated to satisfy the requirements of the room sensor.

Floor Sensor Only

When operation with only a floor sensor, the on time for the Heat relay is calculated to satisfy the requirements of the floor sensor. The floor temperature varies between the floor minimum and the floor maximum settings.

Note: Operation with only a floor sensor can lead to either overheating or underheating of the space.

Room and Floor Sensor

When operating with both a room and floor sensor, the thermostat calculates an on time for the Heat relay to satisfy the floor sensor and an on time to satisfy the room sensor. The Heat relay operates for the longer of these two on times.

During light heating loads, overheating can occur due to the minimum floor temperature setting.

During heavy heating loads, the maximum floor temperature setting limits the on time of the Heat relay. In this situation, underheating can occur.

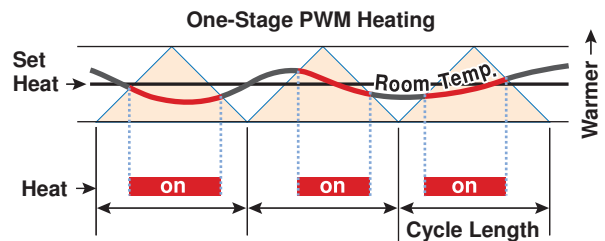

Two Stage Heating

The temperature in a two stage zone is controlled by varying the on time of the Heat 1 and Heat 2 relays during a cycle. Under light loads, the Heat 1 relay is cycled on and off. As the load increases, the Heat 1 relay on time is increased until it reaches the maximum of the cycle length or, if a floor sensor is used, the slab temperature reaches the floor maximum setting. The Heat 2 relay is then cycled and its on time is increased as the load increases.

When the heating load decreases, the on time of the Heat 2 relay is reduced until the Heat 2 relay is turned off completely. The thermostat then reduces the on time of the Heat 1 relay.

Note: When using a floor sensor, the Heat 2 relay may be on while the Heat 1 relay is off if the floor temperature has reached the floor maximum setting.

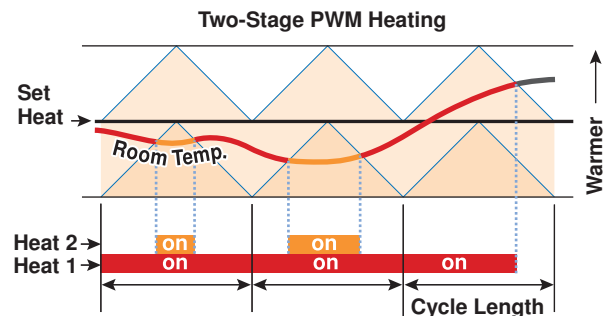

Room Sensor Only

When operating with only an air sensor, the on times for the Heat 1 and Heat 2 relays are calculated to satisfy the requirements of the room sensor.

Floor Sensor Only

When operating with only a floor sensor, the on times for the Heat 1 and Heat 2 relays are calculated to satisfy the requirements of the floor sensor. The thermostat operates to maintain the floor at the minimum floor temperature setting.

Note: Operating with only a floor sensor can lead to either overheating or underheating of the space.

Room and Floor Sensor

When operating with both room and floor sensors, the thermostat calculates an on time for the Heat 1 relay to satisfy the floor sensor's requirements and on times for the Heat 1 and Heat 2 relays to satisfy the room sensor's requirements. The thermostat operates the Heat 1 relay for the longer of these two on times.

While the minimum floor temperature is satisfied, the on times of the Heat 1 and Heat 2 relays are calculated to satisfy the room temperature requirements.

During heavy loads, the maximum floor temperature setting limits the on time of the Heat 1 relay. In this situation, the Heat 2 relay may be on while the Heat 1 relay is off.

Note: During light heating loads, overheating can occur due to the minimum floor temperature requirements.

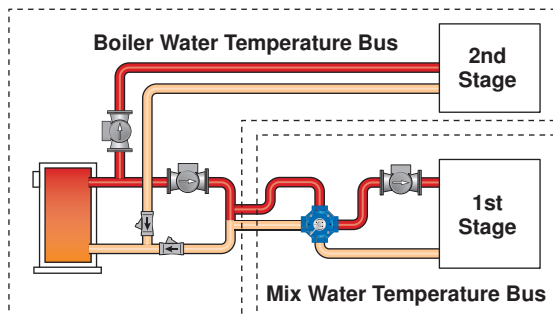

Second Stage Heat Source

The tN4 System Control needs to know whether second stage heating operates a non-hydronic heating system, a boiler water temperature zone, or a mixed water temperature zone.

- If using non-hydronic, set to None.
- If using boiler temperature water, set to Boil.
- If using a mix water temperature, enter the correct Mix bus number.

System Pump Operation

When a tN4 System Control is used, each tN4 bus has a system pump.

- If the tN4 bus's system pump must turn on when the Heat 1 relay is on, set the H1 Pump setting in the Adjust menu to On.
- If the tN4 bus's system pump must turn on when the Heat 2 relay is on, set the H2 Pump setting in the Adjust menu to On.

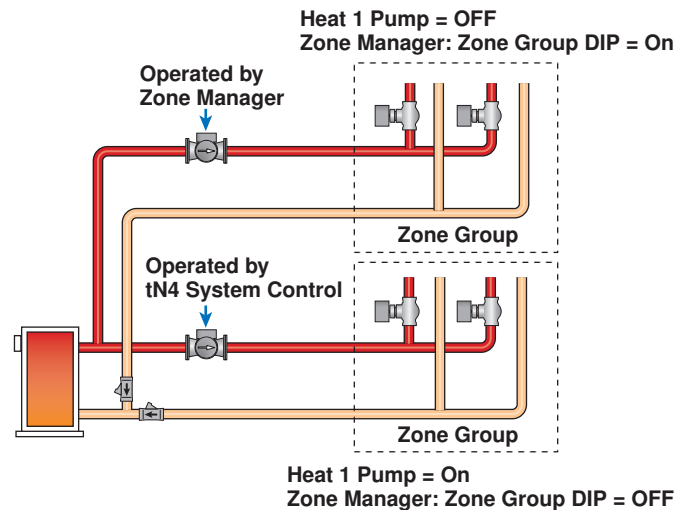

Thermal Motor Zone Valves

When using a thermal motor zone valve, system pump operation must be delayed to allow the thermal motor zone valve to fully open.

- When thermal motor zone valves are used set the Heat Delay setting to On.

The thermostat can operate with other thermostats on a tN4 network in a cool group. When operating as a cool group, the air temperature readings of all the thermostats in the group are averaged. A single thermostat controls the operation of the cooling equipment and is called the cool group master. This operation is based on the averaged temperature of all the thermostats in the cool group.

In a cool group, one thermostat is assigned as the cool group master. The cool group master operates the cooling equipment for the group. The other thermostats are assigned as members of the cool group. Cool groups are assigned using a number 1 through 16 and there can be up to a maximum of 16 cool groups on the entire tN4 network.

Each Cool Group can have up to 24 members.

- To assign a thermostat as the cool group master of group 1, go to the Adjust menu. Select Cool Master and set to 01.
- To assign a thermostat as a cool group member of group 1, go to the Adjust menu. Select Cool Member item and set to 01.
- Repeat the same steps to set up additional cooling groups.

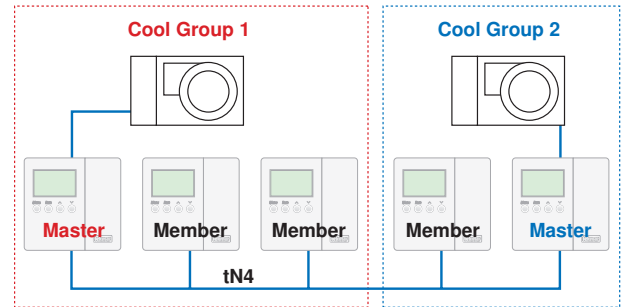

The thermostat has a built-in time clock to allow the thermostat to operate on a schedule. A battery less backup allows the thermostat to keep time for up to 4 hours without power.

- Use the Time menu to set the correct time.

To provide greater energy savings, you can operate the thermostat on a programmable schedule. The schedule is stored in memory and is not affected by loss of power to the thermostat. A single thermostat zone or multiple devices on the network can be assigned to follow the schedule of one thermostat.

Zone Schedule

A zone schedule only applies to the thermostat on which the schedule is programmed. The thermostat follows the zone schedule and the events are not communicated to other thermostats.

Master Schedule

If the thermostat is connected to other thermostats, then the thermostat can operate on a master schedule. You can set up a maximum of four master schedules on the tN4 network. A master schedule is available to all devices on the tN4 network. Master schedules simplify installation since one master schedule may be used by multiple devices.

To create a master schedule:

1. Assign a thermostat as a schedule master by setting the Heat Schedule or Cool Schedule item in the Schedule menu to Master (MST) 1 to 4.

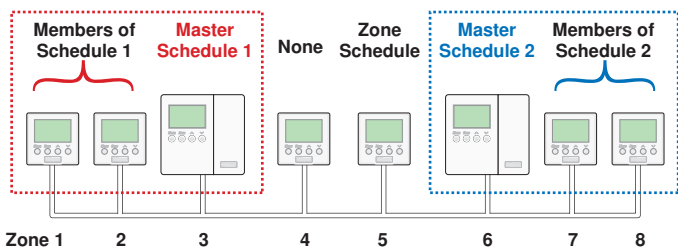

To follow a master schedule:

1. Assign a thermostat to follow a master schedule, by setting the Heat Schedule menu item in the Schedule menu to Member (MBR) 1 to 4.

Once a thermostat is the master schedule, a clock symbol and number appear on the display in the View menu. The number identifies the master schedule number. This helps you locate the master schedule if you need to change the schedule.

Schedule Types

The schedule type determines when the schedule repeats itself. This thermostat includes four schedule types:

- 24 Hour: Repeats every 24 hours.
- 5-2: Repeats on a weekly basis. However, it breaks the week into the weekend and weekdays. This reduces the amount of schedule event settings.
- 5-11: Repeats on a weekly basis. However, it breaks the week into Saturday and Sunday followed by the weekdays. This reduces the amount of schedule event settings.
- 7 Day: Repeats on a weekly basis and allows for separate event times for each day.

	Schedule Type			
Day	24 Hour	5-2	5-11	7 day
Sa			•	•
Su		•	•	•
Mo				•
Tu	•			•
We		•	•	•
Th				•
Fr				•

Schedule Mode

The schedule mode can have either 4 or 2 events per day. An event is a time at which the thermostat changes the set temperature. The event time can be set to the nearest 10 minutes. If you wish to have the thermostat skip the event, enter “- -: -” as the time. The “- -: -” time is found between 11:50 PM and 12:00 AM. See the table, Schedule Mode, for more details regarding types of events.

Schedule Mode	Event	24Hr	Sat	Sun	Mon	Tue	We	Thu	Fri
4 events per day	Wake	6:00 AM	6:00 AM	6:00 AM	6:00 AM	6:00 AM	6:00 AM	6:00 AM	6:00 AM
	Unoccupied	8:00 AM	8:00 AM	8:00 AM	8:00 AM	8:00 AM	8:00 AM	8:00 AM	8:00 AM
	Occupied	6:00 PM	6:00 PM	6:00 PM	6:00 PM	6:00 PM	6:00 PM	6:00 PM	6:00 PM
	Sleep	10:00 PM	10:00 PM	10:00 PM	10:00 PM	10:00 PM	10:00 PM	10:00 PM	10:00 PM
or									
2 events per day	Occupied	6:00 AM	6:00 AM	6:00 AM	6:00 AM	6:00 AM	6:00 AM	6:00 AM	6:00 AM
	Unoccupied	10:00 PM	10:00 PM	10:00 PM	10:00 PM	10:00 PM	10:00 PM	10:00 PM	10:00 PM

When using a schedule, there is a time lag as one event transitions to another. The four possible transitions are:

- Wake to Unoccupied
- Unoccupied to Occupied
- Occupied to Sleep
- Sleep to Wake

When an outdoor temperature measurement is available, the Optimum Start/Stop feature predicts how long the temperature transition takes. This allows the thermostat to operate the heating or cooling system before the scheduled event in order to have the room at the desired temperature at the scheduled event time.

When an outdoor temperature measurement is not available, then the Optimum Start/Stop feature operates slightly differently. First, the thermostat predicts how long the transition takes when changing from a low temperature to a high temperature. It does not track transitions where the temperature setting drops from a high temperature to a low temperature.

- Locate the Optimum Start/Stop setting in the Adjust menu.

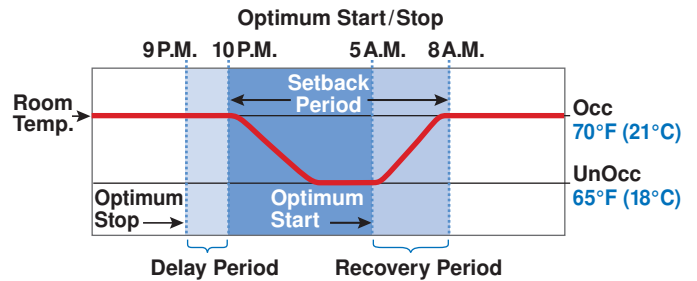
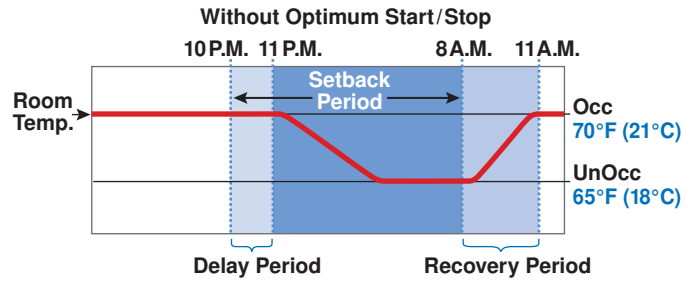

Scenes

Section K

Scenes are a function that is available on the thermostat.

- To use the scene function, go to the Scene menu and set the Scene setting to On.

Scenes are a method of changing the temperature throughout an entire building from a single thermostat. A permanent scene remains in place until another scene is selected. When a temporary scene is selected (Scenes 6, 7, 8), a timer counts down and when it times out, devices return to the last permanent scene selected.

See the Scene table for details regarding the timing of Scenes. There are a total of eight Scenes available.

- Default Scene: The default scene is Permanent 1. In a typical installation, the thermostat will be set to follow the scheduled event in the Permanent 1 scene.
- Factory Set Scenes: Scenes 2, 3 and 6 are factory set and force the thermostat to the Away, Unoccupied or the Occupied temperature respectively.
- Customized Scenes: You can customize Scenes 1, 4, 5, 7, and 8 to either follow the scheduled event, or the temperature can be forced to the Wake, Unoccupied, Occupied, Sleep, or the Away temperature.

Note: If no schedule is available, the Scene menu selections are limited to Occupied and Away.

Scene	Description	Thermostat Operation
1	Permanent 1	Scheduled event, Wake, Unoccupied, Occupied, Sleep, Away
2	Permanent Away 2	Away DHW demands are ignored (applies to outdoor reset modules) Setpoint demands operate (applies to outdoor reset modules)
3	Permanent Unoccupied 3	Unoccupied
4	Permanent 4	Scheduled event, Wake, Unoccupied, Occupied, Sleep, Away
5	Permanent 5	Scheduled event, Wake, Unoccupied, Occupied, Sleep, Away
6	Temporary Occupied 6	Occupied for 3 hours
7	Temporary 7	Scheduled event, Wake, Unoccupied, Occupied, Sleep, Away for 4 hours
8	Temporary 8	Scheduled event, Wake, Unoccupied, Occupied, Sleep, Away for 8 hours

Example 1:

A house is normally in scene Permanent 1. There is a master bedroom that operates on a schedule and there is a guest bedroom that is normally set to Unoccupied. When a guest arrives, the scene changes to Permanent 4. Scene 4 has been pre-programmed to change the guest room to operate on the schedule.

Master bedroom thermostat:

Scene Permanent 1 is set to Schedule.

Scene Permanent 4 is set to Schedule.

Guest bedroom thermostat:

Scene Permanent 1 is set to Unoccupied.

Scene Permanent 4 is set to Schedule.

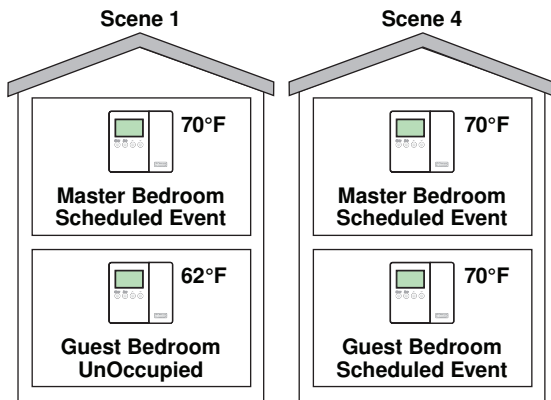

Example 2:

A house is normally in scene Permanent 1. There are bedrooms upstairs and the entertainment area is downstairs. The occupants are entertaining guests for an evening and scene Temporary 7 is selected. This causes the upstairs thermostats to operate at the Unoccupied temperature and the downstairs to operate and the Occupied temperature for four hours.

Upstairs thermostats:

Scene Permanent 1 is set to Schedule.

Scene Temporary 7 is set to Unoccupied.

Downstairs thermostats:

Scene Permanent 1 is set to Schedule.

Scene Temporary 7 is set to Occupied.

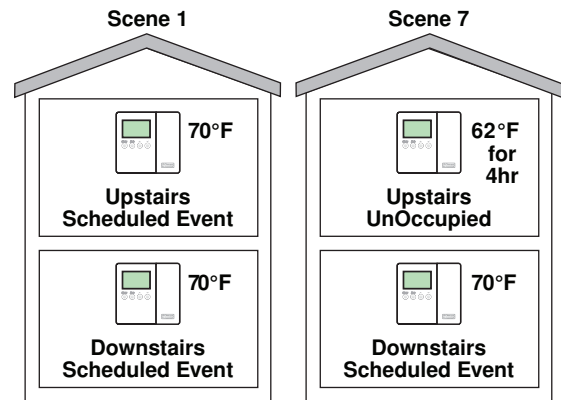

Away Hold

Section L

To set the temperature while the occupants are away, use the Permanent Away 2 scene. This scene changes all thermostats on the network to the Away temperature setting. If there is an Outdoor Reset Module on the tN4 communication bus, the boiler no longer responds to domestic hot water calls for heat. Setpoint demands continue to operate as in the Occupied mode.

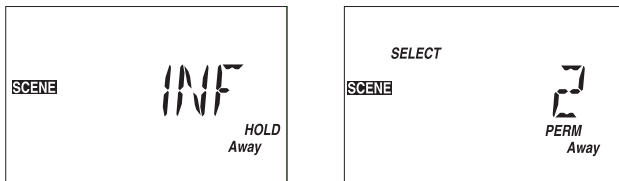

Away Temperatures

An Away temperature setting exists for both heating and cooling. By default, the Set Heat Away temperature is set to 62°F (16.5°C) and the Set Cool Away temperature is set to 85°F (29.5°C).

- To set the Away temperature, go to the Adjust menu and select the Set Heat Away and the Set Cool Away items. The Access Level must be set to Installer or Advanced.

Length of Time Away

The Away Hold feature allows you to set the number of days the Away temperature applies.

- To set the number of days away, go to the Scene menu and select Away Hold.

When set to Infinite, the Permanent Away 2 scene remains until a new scene is selected. If you know in advance how long the building occupant will be away, you can adjust Away Hold to the number of days. Once the number of days have elapsed, the thermostat automatically changes from the Permanent Away 2 scene to previous permanent scene.

Example: The home occupants are traveling for 14 days. They want the home to be at the Away temperatures for 14 days and then automatically return to the normal schedule.

- Away Hold is set to 14 days.
- Scene is changed to Permanent Away 2.

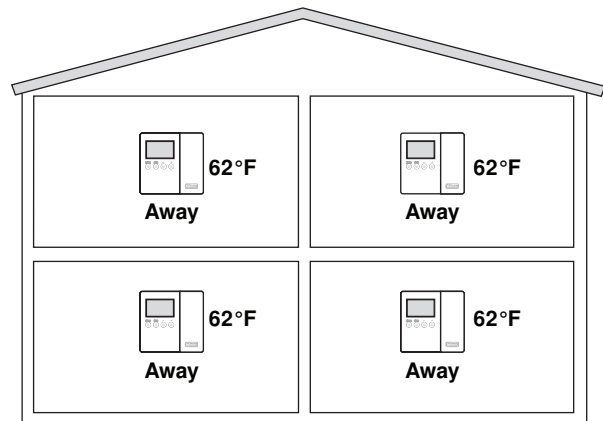

Offset

Section M

This thermostat uses a high quality temperature thermistor and is calibrated to accurately read the room temperature. However, if you wish to fine tune the measured room

temperature, use the Offset feature to increase or decrease room temperature in tenths of degrees.

- Locate the Offset setting in the Misc menu.

Warm Weather Shut Down

Section N

The Warm Weather Shut Down (WWSD) feature prevents the heating system (including floor minimum temperatures) from operating after the outdoor temperature exceeds the WWSD temperature setting. You can follow the tN4 System

Control's WWSD or you can set WWSD temperatures for the Wake and Occupied events, and for the Unoccupied and Sleep events.

- Locate the WWSD setting in the Adjust menu.

Units of Temperature

Section O

The thermostat can display temperatures in either Fahrenheit (°F) or in Celsius (°C).

- Locate the units setting in the Misc menu.

Backlight

Section P

Use the thermostat's backlight to increase the visibility of the display. You can set the backlight to On, Temporary, or Off. If you select On, the backlight remains permanently on. If you select Temporary, the backlight comes on for 30

seconds when a button is pressed. If you select Off the backlight remains permanently off. By default, the backlight is set to Temporary.

- Locate the Backlite setting in the Misc menu.

tN4 Address

Section Q

When connected to other tN4 devices through a tN4 bus, the thermostat is automatically assigned a network address. The tN4 address is useful when trying to correct bus error open and short circuits.

The address includes the bus water temperature designation and a device number. The bus water temperature designations available are Boiler, Mix 1, Mix 2, etc. The device number can range from 1 to 24. If the thermostat is operating as a member of a thermostat-only network, the thermostat does not have an address and the address item in the MISC menu is not available.

The device number determines the heating priority for each zone. A thermostat with device number 1 has a higher priority

than device number 24. The tN4 address allows the tN4 system control to shut off low priority zones when the heat source is unable to heat all zones simultaneously. In some cases, the installer may want to change the thermostat's address in order to change the thermostat's priority relative to other thermostats.

Note: Keep track of manually set tN4 addresses. When a tN4 address is manually set, tN4 thermostats using the Auto Address setting will automatically be assigned new addresses.

If two thermostats are manually set to the same address, an error message will appear. The error remains until one of the addresses is manually changed to a vacant address.

Pump Exercising

Section R

When connected to a tN4 system control, the thermostat exercises the pump relays for 10 seconds every 3 days. Exercising helps prevent pump seizure. While the thermostat is exercising, the display shows "Test".

Exercising does not occur when:

- Mode of Operation is set to Off.
- Heat Source is set to Other.
- DIP switch 2 is set to None.

Error Messages

Local Errors and Device Errors

Error messages are used to indicate a problem somewhere in the system. There are two types of error messages: Local Errors and Device Errors.

A Local Error indicates an error specific to a device. For example, a thermostat with a sensor short circuit will show a Sensor Short Error on its display. No other devices will show this specific error (unless they also have a sensor short circuit).

A Device Error is used to indicate that there is a local error somewhere else on the system. For example, if a thermostat has a sensor short circuit, that thermostat will show a Local Error indicating specifically what the problem is. All other devices on the network will show Device Errors, indicating the address of the device with the Local Error. In other words, Device Errors are nothing more than pointers, showing you that there is a local error somewhere on the system and where to find it.

Error Priority

Only one error can be shown on a particular device at a time. If there is more than one error on the system, the highest priority error will be the one that is shown. The table on pages 37 and 38 lists error messages in order of high priority to low priority.

How to Locate an Error Message

If the warning symbol (flashing circle with exclamation mark) is visible on screen, this indicates that there is an error somewhere on the system. To view the error message, you must first put the control into the Advanced or Installer access level (available in MISC menu). When an error message is present, it is available as an item in the VIEW menu.

While in the View Menu, press the item button until the error message is displayed. You may have to advance through several View Menu items before the message is displayed.

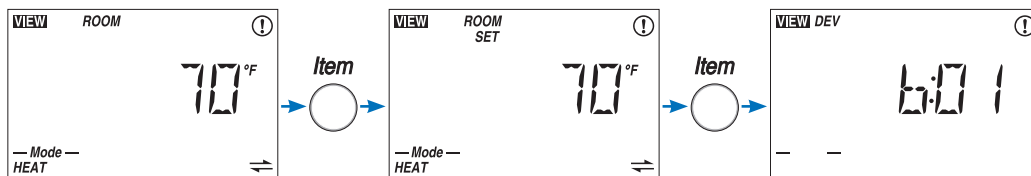

If the error message is a Device Error (if “DEV” or “DEV ERR” is shown on screen), read the address shown and go to the device with that address. That device will have a Local Error indicating specifically what the problem is. When the problem is corrected, the error message will automatically clear.

Access Levels

In some cases, it is not desirable to let day-to-day users view error messages. In these cases, by lowering the access level of the thermostat or setpoint device to ‘User’ or lower, error messages cannot be seen in the View menu and the warning symbol only appears if there is a local error or a device error caused by a critical error on another device. If there is an error message on the system that you cannot find on a particular thermostat, make sure that the access level on that thermostat is set to Installer or Advanced.

Sensor Temperature Errors

If a control is unable to display a temperature due to a sensor malfunction or communication problem, the word “Err” is displayed in place of the temperature. This usually indicates that there is an error somewhere on the system but is not the actual error message. Keep looking through the View menu to find the actual error message.

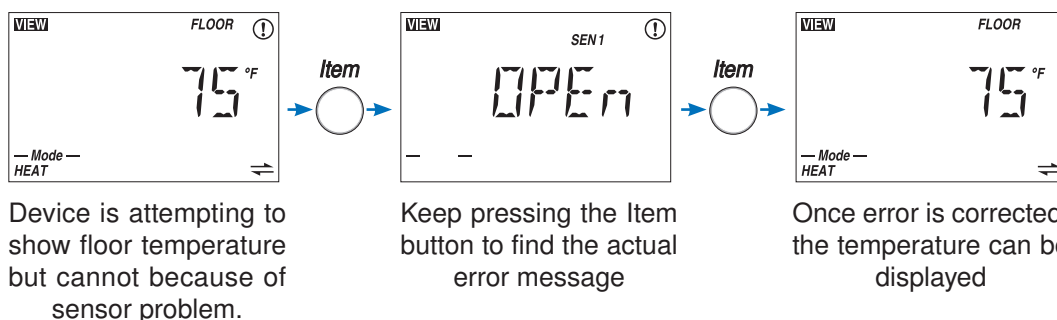

Error Messages

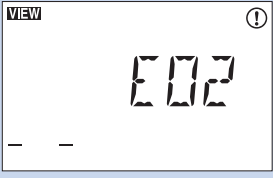
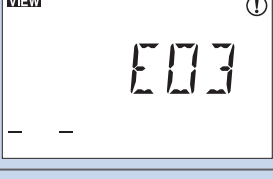
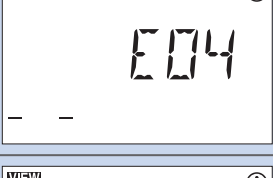
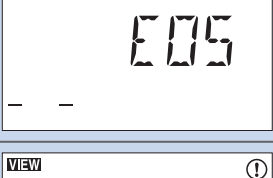
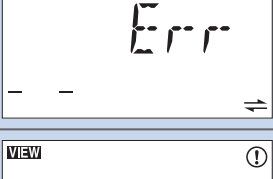
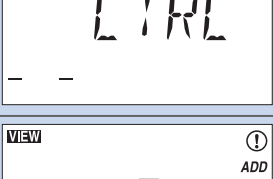
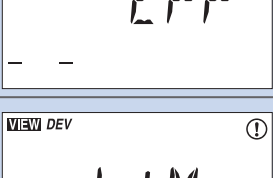
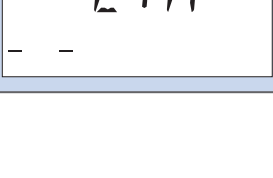

Error Messages (1 of 3)

Error Message	Description
 <p>VIEW !</p> <p style="text-align: center;">E01</p> <p>— —</p>	<p>ADJUST ERROR</p> <p>The thermostat failed to read the Adjust menu settings from memory and has reloaded the factory default settings. Operation stops until you check the Adjust menu settings. The thermostat provides freeze protection only until you check the Adjust menu items.</p> <p>Note: To clear the error, the access level must be set to Advanced before checking the settings in the Adjust menu.</p>
 <p>VIEW !</p> <p style="text-align: center;">E02</p> <p>— —</p>	<p>TIME ERROR</p> <p>The thermostat failed to read the Time menu settings from memory and has reloaded the factory default settings. The thermostat continues to operate while displaying this error.</p> <p>Note: To clear the error, the access level must be set to Advanced before checking the settings in the Time menu.</p>
 <p>VIEW !</p> <p style="text-align: center;">E03</p> <p>— —</p>	<p>SCENE ERROR</p> <p>The thermostat failed to read the Scene menu settings from memory and has reloaded the factory default settings. The thermostat continues to operate while displaying this error.</p> <p>Note: To clear the error, the access level must be set to Advanced before checking the settings in the Scene menu.</p>
 <p>VIEW !</p> <p style="text-align: center;">E04</p> <p>— —</p>	<p>SCHEDULE ERROR</p> <p>The thermostat failed to read the Schedule menu settings from memory and has reloaded the factory default settings. The thermostat continues to operate while displaying this error.</p> <p>Note: To clear the error, the access level must be set to Advanced before checking the settings in the Schedule menu.</p>
 <p>VIEW !</p> <p style="text-align: center;">E05</p> <p>— —</p>	<p>MISCELLANEOUS ERROR</p> <p>The thermostat failed to read the Miscellaneous menu settings from memory and has reloaded the factory default settings. The thermostat continues to operate while displaying this error.</p> <p>Note: To clear the error, the access level must be set to Advanced before checking the settings in the Miscellaneous menu.</p>
 <p>VIEW !</p> <p style="text-align: center;">Err</p> <p>— — ⇐</p>	<p>tN4 BUS ERROR</p> <p>Due to a short or open circuit, communication is lost with the tN4 bus. Check wires for damage. Check 'C' and 'R' wires for polarity. All devices on the tN4 bus will display this error if there is a short circuit. If the error is only on this device, check for an open circuit between the thermostat and Zone Manager. Once the error is corrected press any button to clear the error.</p>
 <p>VIEW !</p> <p style="text-align: center;">CTRL</p> <p>— —</p>	<p>NO tN4 SYSTEM CONTROL</p> <p>The tN4 System Control DIP switch is set to tN4 System Control and the thermostat does not detect the tN4 System Control. Once the tN4 System Control is detected, this error will clear automatically.</p> <p>Note: If a tN4 System Control is not installed, set the tN4 System Control DIP switch to None.</p>
 <p>VIEW !</p> <p style="text-align: center;">Err</p> <p>— — ADD</p>	<p>ADDRESS ERROR</p> <p>Two thermostats have been manually set to the same address. The thermostat continues to operate with this error but does not communicate with the tN4 bus. To clear this error select an unused address. This can be done automatically by setting the Address item to Auto.</p>
 <p>VIEW DEV !</p> <p style="text-align: center;">LIM</p> <p>— —</p>	<p>DEVICE LIMIT</p> <p>You have installed more than 24 devices on the tN4 bus. You must remove the additional devices and move them to a different bus if possible.</p>

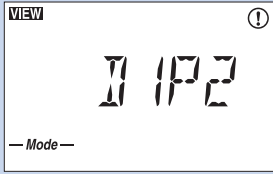
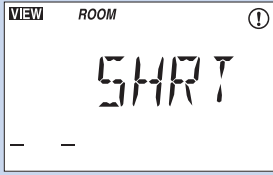
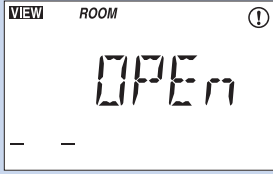
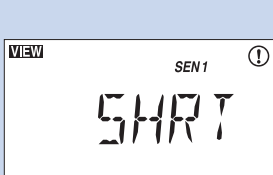
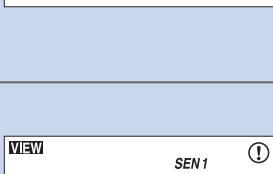
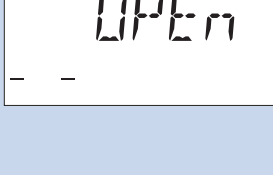
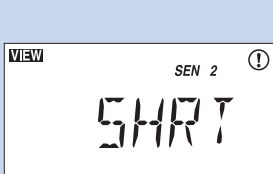
Error Messages (2 of 3)

Error Message	Description
	<p>DIP SWITCH 2 MODE</p> <p>The tN4 System Control DIP switch is set to None and the thermostat has detected a tN4 System Control. The thermostat does not operate until this error is corrected. The tN4 System Control DIP switch must be set to tN4 System Control.</p>
	<p>ROOM SENSOR SHORT CIRCUIT</p> <p>Due to a short circuit, the thermostat failed to read the built-in sensor. If either Sensor 1 or 2 is set to ROOM, or the thermostat is connected to a tN4 System Control, the thermostat continues to operate. Otherwise, the thermostat stops operation. To clear the error, press either the Menu or Item button. If the error does not clear, contact your tekmar sales representative.</p>
	<p>ROOM SENSOR OPEN CIRCUIT</p> <p>Due to an open circuit, the thermostat failed to read the built-in sensor. If either Sensor 1 or 2 is set to ROOM, or the thermostat is connected to a tN4 System Control, the thermostat continues to operate. Otherwise, the thermostat stops operation. To clear the error, press either the Menu or Item button. If the error does not clear, contact your tekmar sales representative.</p>
	<p>SENSOR 1 SHORT CIRCUIT</p> <p>Due to a short circuit, the thermostat failed to read the Sensor 1. The thermostat displays the error and continues to operate unless:</p> <ul style="list-style-type: none"> No other Room sensors are available and the thermostat is not connected to a tN4 System control. Then the thermostat stops operation. No other Floor sensors are available and the Floor Maximum is not set to Off, then the H1 contact no longer operates. <p>Locate and repair the problem as described in the Data Brochure D070. Once the error is corrected, press any button to clear the error.</p>
	<p>SENSOR 1 OPEN CIRCUIT</p> <p>Due to an open circuit, the thermostat failed to read the Sensor 1. The thermostat displays the error and continues to operate unless:</p> <ul style="list-style-type: none"> No other Room sensors are available and the thermostat is not connected to a tN4 System control. Then the thermostat stops operation. No other Floor sensors are available and the Floor Maximum is not set to Off, then the H1 contact no longer operates. <p>Locate and repair the problem as described in the Data Brochure D070. Once the error is corrected, press any button to clear the error.</p>
	<p>SENSOR 2 SHORT CIRCUIT</p> <p>Due to a short circuit, the thermostat failed to read Sensor 2. The thermostat displays the error and continues to operate unless:</p> <ul style="list-style-type: none"> No other Room sensors are available and the thermostat is not connected to a tN4 System control. Then the thermostat stops operation. No other Floor sensors are available and the Floor Maximum is not set to Off, then the H1 contact no longer operates. <p>Locate and repair the problem as described in the Data Brochure D070. Once the error is corrected, press any button to clear the error.</p>
	<p>SENSOR 2 OPEN CIRCUIT</p> <p>Due to an open circuit, the thermostat failed to read Sensor 2. The thermostat displays the error and continues to operate unless:</p> <ul style="list-style-type: none"> No other Room sensors are available and the thermostat is not connected to a tN4 System control. Then the thermostat stops operation. No other Floor sensors are available and the Floor Maximum is not set to Off, then the H1 contact no longer operates. <p>Locate and repair the problem as described in the Data Brochure D070. Once the error is corrected, press any button to clear the error.</p>

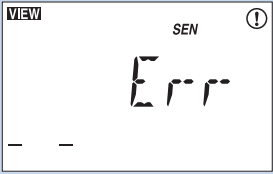
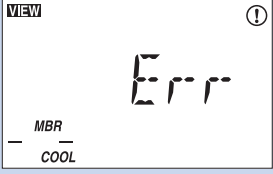
Error Messages (3 of 3)

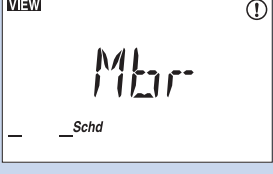
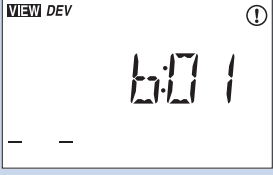
Error Message	Description
	<p>SENSOR ERROR</p> <p>All of the sensors have been set to Off or None including the built-in sensor and the tN4 System Control DIP switch is set to None. The thermostat stops operation.</p> <p>Turn on at least one sensor or connect the thermostat to a tN4 system control and set the tN4 System Control DIP switch to tN4 System Control.</p>
	<p>COOL GROUP MEMBER ERROR</p> <p>The thermostat can no longer detect its cool group master. Check the communication connections for open or short circuits. Once the cool group master has been detected, the error message clears.</p>
	<p>SCHEDULE MASTER ERROR</p> <p>Two thermostats have been set to the same SCH MSTR setting. Select a different SCH MSTR setting for the thermostat. The thermostat operates in the Occupied mode while this error message is present. The error message clears automatically once the error is corrected.</p>
	<p>SCHEDULE MEMBER ERROR</p> <p>The thermostat can no longer detect its schedule master. Check the communication connections for open or short circuits. Once the schedule master has been detected, the error message clears.</p>
	<p>DEVICE ERROR AT ADDRESS #:##</p> <p>#:## is the address of the device with the error. The bus number displays before the colon, and the device number displays after. Go to the device with the address displayed.</p> <p><u>Possible Addresses:</u></p> <ul style="list-style-type: none"> 01 to 24 - Device Error on Thermostat only network b:01 to b:24 - Device Error on Boiler Bus 1:01 to 1:24 - Device Error on Bus 1 2:01 to 2:24 - Device Error on Bus 2 3:01 to 3:24 - Device Error on Bus 3 CTRL - Device Error on System Control MIX1 - Device Error on Mixing Expansion Module (See System Control for local error) MIX2 - Device Error on Mixing Expansion Module (See System Control for local error) MIX3 - Device Error on Mixing Expansion Module (See System Control for local error)

Cleaning the Thermostat

The thermostat's exterior can be cleaned using a damp cloth. Moisten the cloth with water and wring out prior to wiping the control. Do not use solvents or cleaning solutions.

Limited Warranty and Product Return Procedure

Limited Warranty *The liability of tekmar under this warranty is limited. The Purchaser, by taking receipt of any tekmar product ("Product"), acknowledges the terms of the Limited Warranty in effect at the time of such Product sale and acknowledges that it has read and understands same.*

The tekmar Limited Warranty to the Purchaser on the Products sold hereunder is a manufacturer's pass-through warranty which the Purchaser is authorized to pass through to its customers. Under the Limited Warranty, each tekmar Product is warranted against defects in workmanship and materials if the Product is installed and used in compliance with tekmar's instructions, ordinary wear and tear excepted. The pass-through warranty period is for a period of twenty-four (24) months from the production date if the Product is not installed during that period, or twelve (12) months from the documented date of installation if installed within twenty-four (24) months from the production date.

The liability of tekmar under the Limited Warranty shall be limited to, at tekmar's sole discretion: the cost of parts and labor provided by tekmar to repair defects in materials and / or workmanship of the defective product; or to the exchange of the defective product for a warranty replacement product; or to the granting of credit limited to the original cost of the defective product, and such repair, exchange or credit shall be the sole remedy available from tekmar, and, without limiting the foregoing in any way, tekmar is not responsible, in contract, tort or strict product liability, for any other losses, costs, expenses, inconveniences, or damages, whether direct, indirect, special, secondary, incidental or consequential, arising from ownership or use of the product, or from defects in workmanship or materials, including any liability for fundamental breach of contract.

The pass-through Limited Warranty applies only to those defective Products returned to tekmar during the warranty period. This Limited Warranty does not cover the cost of the parts or labor to remove or transport the defective Product, or to reinstall the repaired or replacement Product, all such costs and expenses being subject to Purchaser's agreement and warranty with its customers.

Any representations or warranties about the Products made by Purchaser to its customers which are different from or in excess of the tekmar Limited Warranty are the Purchaser's sole responsibility and obligation. Purchaser shall indemnify and hold tekmar harmless from and against any and all claims, liabilities and damages of any kind or nature which arise out of or are related to any such representations or warranties by Purchaser to its customers.

The pass-through Limited Warranty does not apply if the returned Product has been damaged by negligence by persons other than tekmar, accident, fire, Act of God, abuse or misuse; or has been damaged by modifications, alterations or attachments made subsequent to purchase which have not been authorized by tekmar; or if the Product was not installed in compliance with tekmar's instructions and / or the local codes and ordinances; or if due to defective installation of the Product; or if the Product was not used in compliance with tekmar's instructions.

THIS WARRANTY IS IN LIEU OF ALL OTHER WARRANTIES, EXPRESS OR IMPLIED, WHICH THE GOVERNING LAW ALLOWS PARTIES TO CONTRACTUALLY EXCLUDE, INCLUDING, WITHOUT LIMITATION, IMPLIED WARRANTIES OF MERCHANTABILITY AND FITNESS FOR A PARTICULAR PURPOSE, DURABILITY OR DESCRIPTION OF THE PRODUCT, ITS NON-INFRINGEMENT OF ANY RELEVANT PATENTS OR TRADEMARKS, AND ITS COMPLIANCE WITH OR NON-VIOLATION OF ANY APPLICABLE ENVIRONMENTAL, HEALTH OR SAFETY LEGISLATION; THE TERM OF ANY OTHER WARRANTY NOT HEREBY CONTRACTUALLY EXCLUDED IS LIMITED SUCH THAT IT SHALL NOT EXTEND BEYOND TWENTY-FOUR (24) MONTHS FROM THE PRODUCTION DATE, TO THE EXTENT THAT SUCH LIMITATION IS ALLOWED BY THE GOVERNING LAW.

Product Warranty Return Procedure All Products that are believed to have defects in workmanship or materials must be returned, together with a written description of the defect, to the tekmar Representative assigned to the territory in which such Product is located. If tekmar receives an inquiry from someone other than a tekmar Representative, including an inquiry from Purchaser (if not a tekmar Representative) or Purchaser's customers, regarding a potential warranty claim, tekmar's sole obligation shall be to provide the address and other contact information regarding the appropriate Representative.



tekmar Control Systems Ltd., Canada
tekmar Control Systems, Inc., U.S.A.
Head Office: 5100 Silver Star Road
Vernon, B.C. Canada V1B 3K4
(250) 545-7749 Fax. (250) 545-0650
Web Site: www.tekmarcontrols.com

