

Zoning

Replaces:01/09

Installation & Operation Manual

Introduction

The tekmarNet[®]4 Thermostat 537 provides operation for:

- One Stage Heat

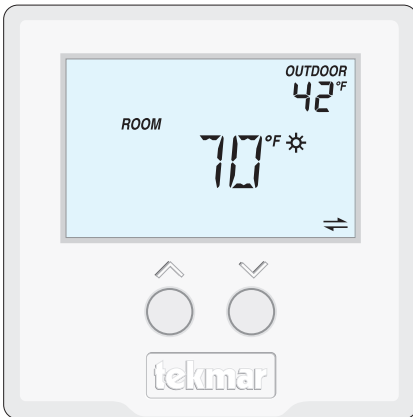

Features

- Requires 4 wires (tN4, C, R, W)
- Outdoor temperature display
- Bright backlight
- 2 button temperature adjustment
- Communication with other tekmarNet[®] devices improves system efficiency and comfort
- Schedule member status enables setback operation
- Optimum start
- Responds to tekmarNet[®] Scenes
- Cooling Group Member
- Freeze protection
- Exercising
- Zone synchronization

Benefits

- Energy savings
- Reduced temperature swings
- Compatible with tekmarNet[®] Timers, User Switches and Gateway for additional control

Table of Contents

Getting Started	2	Settings	8-11
Installation	2	Sequence of Operation.....	12
Caution.....	2	Heating Operation	12
Preparation.....	2	Cooling Group Operation	13
Removing The Thermostat Base...	3	Schedules	14
Mounting The Thermostat Base...	3	Scenes (System Override)	14
Thermostat Wiring	4	Troubleshooting	15
Testing the Thermostat Wiring	4	Error Messages.....	15-16
Mounting the Thermostat	5	Frequently Asked Questions	17
Cleaning the Thermostat.....	6	Job Record.....	18
Switch Settings	6	Technical Data.....	19
User Interface.....	7	Limited Warranty and Product	
Display.....	7	Return Procedure	20
Button Operation	7		
Symbols Description	7		

Getting Started

Congratulations on the purchase of your new tekmar thermostat.

This manual will step through the complete installation, programming and sequence of operation for this control. At the back, there are tips for control and system troubleshooting.

Installation

Caution

Improper installation and operation of this control could result in damage to the equipment and possibly even personal injury or death. It is your responsibility to ensure that this control is safely installed according to all applicable codes and standards. This electronic control is not intended for use as a primary limit control. Other controls that are intended and certified as safety limits must be placed into the control circuit.

Preparation

Tools Required

- tekmar or jeweller screwdriver
- Wire Stripper
- Phillips head screwdriver

Materials Required

- 2, #6 x 1" Wood Screws
- 18 AWG LVT Solid Wire
- Optional Adapter Plate 007 (for installation on 2" x 4" gang box)

Installation Location

Choose the placement of the thermostats early in the construction process to enable proper wiring during rough-in.

Consider the following:

- Interior Wall.
- Keep dry. Avoid potential leakage onto the control.
- Relative Humidity max 92% up to 104°F (40°C), 50% RH above 104°F (40°C). Non-condensing environment.
- No exposure to extreme temperatures beyond 36-122°F (2-50°C).
- No draft, direct sun, or other cause for inaccurate temperature readings.
- Away from equipment, appliances, or other sources of electrical interference.
- Easy access for wiring, viewing, and adjusting the display screen.
- Approximately 5 feet (1.5 m) off the finished floor.
- The maximum length of wire is 500 feet (150 m).
- Strip wire to 3/8" (10 mm) for all terminal connections.
- Use standard 4 conductor, 18 AWG wire.

Removing The Thermostat Base

To remove the thermostat base:

- Place a small slot screwdriver or similar tool into the slot located on the top of the thermostat.
- While pushing down against the plastic tab, pull the thermostat away from the thermostat's base.

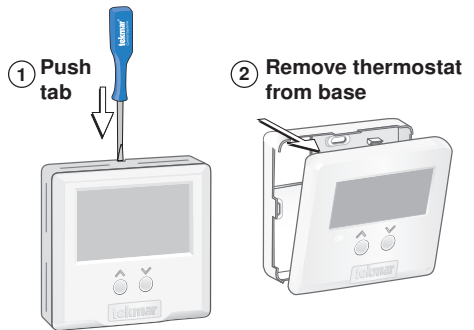

Mounting The Thermostat Base

If a single gang switch box is used, an Adaptor Plate 007 is required to mount the thermostat to the box.

- Fasten the base of the thermostat to the adaptor plate.
- Feed the wiring through the openings in the back of the adaptor plate and thermostat.
- Use the upper and lower screw holes to fasten the adaptor plate to the box.

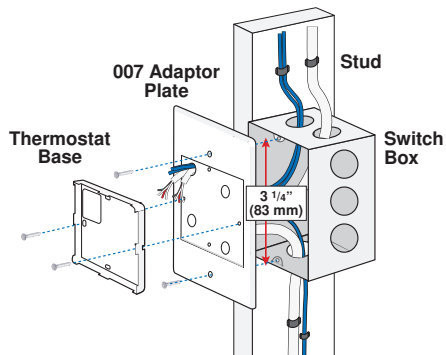

Mounted on switch box

If a switch box was not used, mount the thermostat directly to the wall.

- Feed the wiring through the openings in the back of the thermostat.
- Use screws in the screw holes to fasten the thermostat to the wall. At least one of the screws should enter a wall stud or similar rigid material.

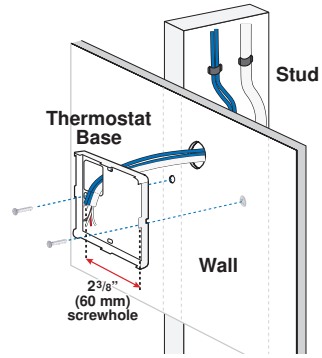

Mounted on wallboard

Thermostat Wiring

The thermostat operates a single heating system zone.

Connect tN4, C, R, and W terminals on the thermostat to the tN4, C, R and W terminals on the tN4 Wiring Center or Zone Manager.

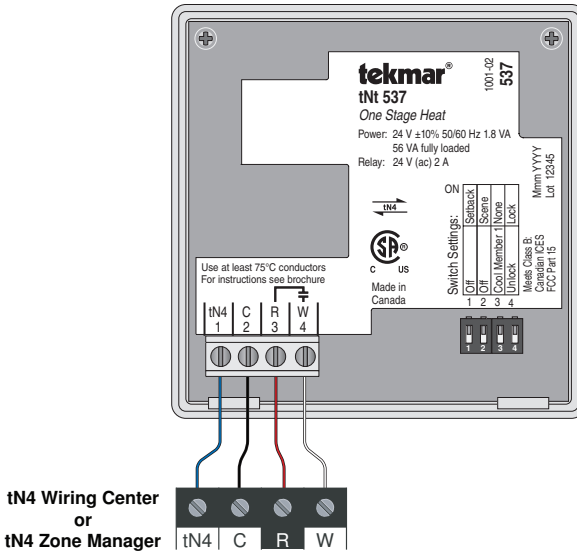

Testing the Thermostat Wiring

Testing the Power

1. Remove the front cover from the thermostat.
2. Use an electrical test meter to measure (ac) voltage between the R and C terminals. The reading should be 24 V (ac) +/- 10%.
3. Install the front cover.

Testing the Heat Relay

1. Remove the front cover from the thermostat.
2. Press the **▼** button and set the heating temperature below the current room temperature. There should be no H1 symbol on the display.
3. Set the electrical test meter to continuity.
4. Place probes between R (3) and W (4). There should be no continuity. If there is continuity then there may be a wiring fault or the relay may be faulty.
5. Press the **▲** button and set the heating temperature above the current room temperature. Make sure the display does not show “WWSD”. The “H1” symbol should appear on the display.
6. There should be continuity between the R (3) and W (4) terminals.

Testing the tekmarNet® 4 Bus

The **↔** symbol is shown on the display when communication is present. If the thermostat is connected in a network and the communication is missing, there may be an open or short circuit on the tN4 and C bus wires.

1. Remove the front cover from the thermostat.
2. To test for short circuits:
 - Disconnect the tN4 bus wires on one end.
 - Install wire nuts on each wire to ensure the wire ends are not touching.
 - Disconnect the tN4 bus wires on the other end.
 - Measure for continuity using an electrical meter.
 - If continuity is present, there is a short circuit fault along the wires. It is recommended to replace the tN4 bus wires.
3. To test for open circuits:
 - Disconnect the tN4 bus wires on one end and connect them together.
 - Disconnect the tN4 bus wires on the other end.
 - Use an electrical meter to measure for continuity.
 - If there is no continuity, there is an open circuit fault along the wires. It is recommended to replace the tN4 bus wires.

Mounting the Thermostat

To place the thermostat back on the mounting base:

- Place thermostat bottom tabs on matching mounting base notches.
- Pivot top of the thermostat towards wall, ensuring wires clear obstructions.
- The top clasp makes a clicking sound when properly closed.

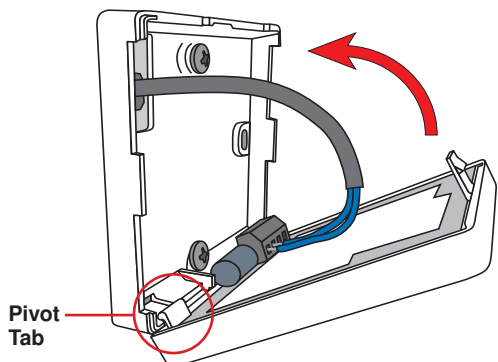

Cleaning the Thermostat

The thermostat's exterior can be cleaned using a damp cloth. Moisten the cloth with water and wring out prior to wiping the control. Do not use solvents or cleaning solutions.

Switch Settings

Switches are set to "On" position from the factory, and do not require changing for most applications.

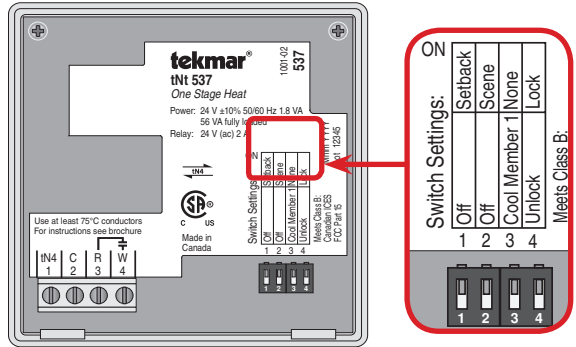

Switch	Position	Action
1	ON	SETBACK The thermostat follows a programmable setback schedule as a schedule member if available. Requires the installation of a Timer 033 to use this feature.
	OFF	OFF The thermostat does not follow a programmable setback schedule.
2	ON	SCENE The thermostat responds to changes in the scene (system wide manual overrides). Requires the installation of a User Switch 479 to use this feature.
	OFF	OFF The thermostat does not respond to scenes.
3	ON	NONE The thermostat is not part of a cooling group.
	OFF	COOL MEMBER 1 The thermostat joins as a member to cooling group 1.
4	ON	LOCK ACCESS LEVEL Locked to 'User' access level. Set to Lock when installation completed.
	OFF	UNLOCK ACCESS LEVEL Unlock to allow 'User' and "Installer" access level. Set to Unlock during installation process. tekmarNet® reset control must also be set to Unlocked (Installer access level).

User Interface

Display

MAIN DISPLAY



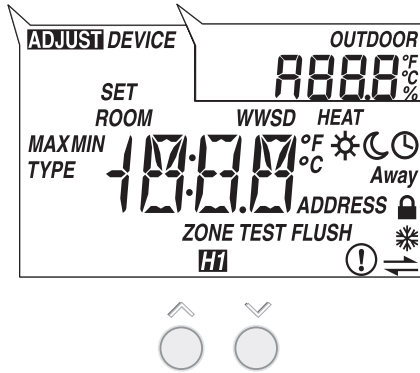





SECONDARY DISPLAY



Button Operation

Press the  or the  button to select the room temperature.

Symbols Description

 HEAT Heat is turned on.	 LOCK Locked to 'User' access level.
 SUN Operating at the occupied (day) temperature.	 CLOCK Operating on a programmable schedule.
 MOON Operating at the unoccupied (night) temperature.	 tekmarNet® Communication is present.
<i>Away</i> AWAY Operating at the <i>Away</i> scene temperature.	 WARNING SYMBOL Indicates an error is present.
 COOL GROUP The cooling group is cooling. Heating can start once the cooling is finished.	WWSD WARM WEATHER SHUT DOWN The heating system has been shut off for the summer.

Settings (1 of 4)

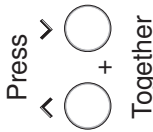



- Press and hold down both the ▲ and ▼ buttons for 2 seconds to change from one step to the next.
- Release both buttons once the step has been reached.
- Press the ▲ or the ▼ button to change the setting, if available.
- Press and hold down both the ▲ and ▼ buttons for 2 seconds to go to the next step, OR
- After 10 seconds of no button activity, the display goes back to normal operation.
- **Note:** Set switch setting #4 and tekmarNet® system control to Unlock to change Access level to Installer.

Display	Range	Access	Description	Set to
	40 to 95°F (4.5 to 35.0°C) Default = 70°F (21.0°C)	Installer User	SET ROOM HEAT ☀ Set the room heating temperature while in the ☀ event.	
	40 to 95°F (4.5 to 35.0°C) Default = 65°F (18.5°C)	Installer User	SET ROOM HEAT ☾ Set the room heating temperature while in the ☾ event.	
	40 to 95°F (4.5 to 35.0°C) Default = 62°F (16.5°C)	Installer	SET ROOM HEAT AWAY Set the room heating temperature while in the <i>Away</i> scene.	

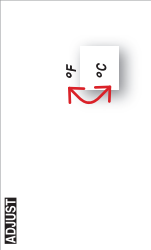

Continued on next page.

Settings (2 of 4)

Display	Range	Access	Description	Set to
	Off, 30 sec, On, On + ☼ Default = 30 sec	Installer User	BACKLIGHT Select the backlight operation. Off = Permanently Off 30 = Temporary on for 30 seconds On = Permanently On On + ☼ = On during ☼ and off during ☾	
	°F or °C Default = °F	Installer User	TEMPERATURE UNITS Press the ^ or the v button to change from °F to °C and vice versa.	
	Device Type with Software Version, Address	Installer User	DEVICE TYPE Display alternates between the Device Type (large number) with Software Version (upper right corner) and the thermostat address.	
	40 to 95 °F (4.5 to 35.0 °C) Default = 85 °F (29.5 °C)	Installer	MAXIMUM SET ROOM HEAT ☼ Set the maximum room heating limit while in the ☼ event.	

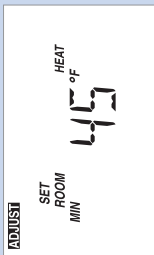

Continued on next page.

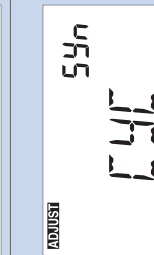
Settings (3 of 4)

Display	Range	Access	Description	Set to
	40 to 95°F (4.5 to 35.0°C) Default = 85°F (29.5°C)	Installer	MAXIMUM SET ROOM HEAT Set the maximum room heating limit while in the ☀ event.	
	40 to 95°F (4.5 to 35.0°C) Default = 45°F (7.0°C)	Installer	MINIMUM SET ROOM HEAT Set the minimum room heating limit.	
	1, 2, 3, 4 Default = 1	Installer	SCHEDULE Thermostat can follow schedule master 1, 2, 3, or 4. Available when: <ul style="list-style-type: none"> • Switch setting 1 is set to Setback (On Position). 	
	Auto, SYN(Synchronize) Default = Synchronize	Installer	HEAT CYCLES PER HOUR Select either Auto cycle or Synchronize with other thermostats on the tekmarNet® system. Choose Synchronize when zone heated using a boiler. Choose Auto when zone is non-hydrionic heating. Available when: <ul style="list-style-type: none"> • No reset control on the tekmarNet® system. 	

Continued on next page.

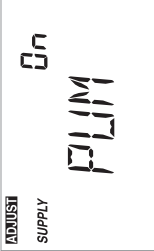
Settings (4 of 4)

Display	Range	Access	Description	Set to
	OFF, dLy (delay), On Default = On	Installer	HEATING SUPPLY PUMP Select whether or not the system supply pump should turn on, be delayed (for thermal motor or wax actuator) or be off to allow a zone group pump per manifold. Available when: <ul style="list-style-type: none"> • A reset control is present on the tekmarNet® system. 	
	01 to 24 (no reset control), b:01 to b:24 (reset control - boiler), 1:01 to 1:24 (reset control - mixing)	Installer	tekmarNet® ADDRESS The address is shown in the large number field. "Auto" is shown in the upper number field when using automatic addressing. Press the ∧ or the ∨ button to manually select an address. The address can be returned to automatic "Auto" addressing when address set above 24.	
	None	Installer User	ESCAPE Press the ∧ or the ∨ button to return to normal operation.	

Sequence of Operation

Heating Operation

Section A

The thermostat operates the heating system to maintain the Set Room Heat temperature. An H1 symbol is shown on the display when the thermostat is heating. The heat can cycle on and off within +/- 1.5°F (1°C) of the Set Room Heat temperature.

Freeze Protection

The thermostat operates the heat whenever the room temperature falls below 40°F (4.5°C).

Exercising

When connected to a tekmarNet® reset control, the thermostat exercises the heat relay for 10 seconds every 3 days. Exercising helps prevent zone valves or zone pumps from failing due to precipitate buildup. During exercising, the thermostat shows “TEST” on the display.

Flushing

The flushing feature is for open-loop systems that use a domestic hot water tank as a heat source. Flushing ensures that fresh potable water is circulated through the system once each day. If the thermostat is connected to a tekmarNet® reset control with the Flushing feature turned on, the thermostat display will display the “FLUSH” icon for the duration of the flushing operation.

Hydronic System Supply Pump

When connected to a tekmarNet® reset control, the thermostat's Supply Pump setting affects how the primary pump or mix pump on the reset control operates. When connected to the boiler bus, the primary pump is affected. When connected to the mix bus, the mix system pump is affected.

If the thermostat operates a motorized zone valve or a zone pump, the Supply Pump setting should be set to On.

If the thermostat operates a thermal motor (wax actuator) zone valve, set the Supply Pump setting to Delay. This provides a three minute delay to allow the zone valve to open before the primary or mix pump is turned on.

In special applications with multiple zoning manifolds, the Supply Pump setting can be set to Off. This allows a Zone Group Pump located on the Zone Manager, or Wiring Center to operate the pump for the manifold.

DHW Tank Priority

When a tekmarNet® reset control is heating an indirect Domestic Hot Water (DHW) tank, the thermostat may shut off the heating zones to allow the DHW tank to recover quickly. This is determined by the DHW priority of the tekmarNet® reset control.

Warm Weather Shut Down

When the outdoor air temperature exceeds the Warm Weather Shut Down (WWSD) setting on the tekmarNet® reset control, the heating system is shut off.

Cooling Group Operation

Section B

In order to prevent heating and cooling at the same time, this thermostat can operate together with other thermostats on a tN4 system to form a cool group.

In a cool group, one thermostat is assigned as the cool group master. The cool group master operates the cooling equipment for the group. This thermostat can be set to be a member of the cool group.

When operating as a cool group, the air temperature readings of all the cool group member thermostats are communicated to the cool group master and a temperature average is determined.

When the cool group master is in cooling operation, the cool group member thermostats do not operate the heating system for air heating.

If the Set Room Heat temperature is adjusted while the cool group is cooling, the snowflake icon is flashed to alert the user that the cooling is presently on. Once the cooling shuts off, the heating can start operation.

This thermostat joins cool group number 1 when switch setting 3 is set to cool member 1 (Off position).

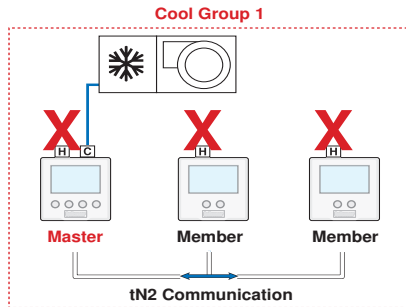

Lowering the room temperature setting reduces the amount of fuel required to heat the building resulting in energy savings.

This thermostat can follow a programmable schedule in order to automatically lower the room temperature setting. A schedule master such as a Timer 033 is required in order to gain programmable schedule functionality.

When operating on a programmable schedule, a ⌚ symbol is shown, as well as a ☀ or a ☾. The ☀ or ☾ indicates the current operating temperature.

If a ⌚ symbol does not appear, there is no schedule available.

Display	Action
☀	Occupied temperature. No schedule.
☾	Unoccupied temperature. No schedule.
☀ ⌚	Programmable schedule at occupied temperature.
☾ ⌚	Programmable schedule at unoccupied temperature.

When a programmable schedule is selected, there is a time delay for the temperature to change from the ☾ temperature to the ☀ temperature.

The thermostat uses Optimum Start to predict the heat up and cool off rate of the room. The optimum start feature allows the room to reach the set room ☀ temperature by the time set in the programmable schedule. This applies for both heating and cooling.

Scenes (System Override)

Section D

Scenes provide an easy way to save energy while away on vacation, or override a pre-set schedule when plans change. tekmarNet® devices such as a User Switch 479 provide scene adjustment.

This thermostat responds to the following scenes:

Scene	Display	Room Temperature Setting
1	☀ or ☀ ⌚ or ☾ ⌚	Follows programmable schedule or operates at the occupied ☀ temperature.
2	Away	Away temperature.
3	☾	Unoccupied ☾ temperature.

While in the *Away* scene, the room temperature cannot be changed using the ^ or v buttons. Change the scene from *Away* to ☀ or ☾ to change the temperature.

Troubleshooting

Error Messages (1 of 2)

Error Message

Description

CONTROL ERROR

The thermostat was unable to correctly read settings from memory and has reloaded the factory default settings. The thermostat does not operate the heating system while this error message is present.

Error clears once all adjust menu settings in the Installer access level (unlocked) have been checked. Set thermostat's switch setting #4 to unlock and unlock the tekmarNet[®] system control. Then press and hold **▲** and **▼** buttons together for 2 seconds to enter the adjust menu. Continue until all settings have been reviewed.

BUS ERROR

The tekmarNet[®]4 communication bus has either an open or a short circuit. The result is that there are no communications. Check for loose wires. Check for short circuits between the tN4 and C wires on the House Control, Wiring Center, or Zone Manager. Check for correct polarity between the C and R wires.

Error clears automatically once wiring fault has been corrected.
If the thermostat is intentionally removed from the tekmarNet[®]4 bus, press the **▲** and **▼** buttons together to clear the error message.

DEVICE LIMIT

The number of devices on the tekmarNet[®] bus has exceeded 24. Devices include tekmarNet[®] Thermostats and Setpoint Controls. The device count must be lowered to 24 or less. If possible, move devices to other tekmarNet[®] buses.

Error clears automatically once the number of devices on the tekmarNet[®] bus is at 24 or lower.



E01 ①



E-4 ①

DEVICE



L M ①

Error Messages (2 of 2)

Error Message

Description

ADDRESS ERROR

This thermostat and another device have been manually given the same tekmarNet® address. Error clears automatically once this thermostat is given a new manually set address or if the thermostat is set to automatic addressing.



ROOM SENSOR SHORT CIRCUIT

The built-in air temperature sensor has a short circuit fault. This error cannot be field repaired. Contact your wholesaler or tekmar sales representative for details on repair procedures.



ROOM SENSOR OPEN CIRCUIT

The built-in air temperature sensor has an open circuit fault. This error cannot be field repaired. Contact your wholesaler or tekmar sales representative for details on repair procedures.



COOL MEMBER ERROR

Switch setting #3 has been selected to join a cooling group as a member, yet there is no cooling group master thermostat. Error clears once the thermostat detects a cool group master or switch setting #3 is set to none.



Frequently Asked Questions

Symptom	Look for...	Corrective Action
No Heat	H1 Symbol	H1 symbol indicates heat is on. Check if zone valve or zone pump is operating.
	Flashing WWSD	Increase WWSD setting on tekmarNet® reset control.
	Flashing Away	Change User Switch to Normal scene 1.
Heat on before scheduled time		Optimum start “learns” the heat up rate of the room and starts the heating early so that the room is comfortable at the scheduled time.
Pressing ^ button does not increase temperature	Flashing Max	Installer can increase the Maximum Set Room Heat limits.
Pressing v button does not decrease temperature	Flashing Min	Installer can decrease the Minimum Set Room Heat limits.

Job Record

Jobsite Location _____

Thermostat Location _____

Item	Setting	Item	Setting
Set Room Heat ☀		Max Set Room Heat ☾	
Set Room Heat ☾		Min Set Room Heat	
Set Room Heat Away		Schedule Member	
Backlight		Heat Cycles Per Hour	
Units		Heating Supply Pump	
Max Set Room Heat ☀		tekmarNet® Address	

Technical Data

tekmarNet[®]4 Thermostat 537; *One Stage Heat*

Packaged weight	0.8 lb. (380 g)
Enclosure	NEMA 1, white PVC plastic
Dimensions	2-7/8" H x 2-7/8" W x 13/16" D (73 x 73 x 21 mm)
Approvals	CSA C US, meets Class B: ICES and FCC Part 15
Ambient conditions	Indoor use only, 36 to 122°F (2 to 50°C).
	RH max 92% to 104°F (40°C), and 50% above 104°F (40°C)
	Altitude <9840 feet (3000 m), Installation Category II, Pollution Degree 2
Power supply	24 V (ac) ± 10% 50/60 Hz, 1.8 VA Standby, 56 VA fully loaded, NEC / CEC Class 2
W Relay	24 V (ac) 2 A

Limited Warranty and Product Return Procedure

Limited Warranty *The liability of tekmar under this warranty is limited. The Purchaser, by taking receipt of any tekmar product ("Product"), acknowledges the terms of the Limited Warranty in effect at the time of such Product sale and acknowledges that it has read and understands same.*

The tekmar Limited Warranty to the Purchaser on the Products sold hereunder is a manufacturer's pass-through warranty which the Purchaser is authorized to pass through to its customers. Under the Limited Warranty, each tekmar Product is warranted against defects in workmanship and materials if the Product is installed and used in compliance with tekmar's instructions, ordinary wear and tear excepted. The pass-through warranty period is for a period of twenty-four (24) months from the production date if the Product is not installed during that period, or twelve (12) months from the documented date of installation if installed within twenty-four (24) months from the production date.

The liability of tekmar under the Limited Warranty shall be limited to, at tekmar's sole discretion: the cost of parts and labor provided by tekmar to repair defects in materials and / or workmanship of the defective product; or to the exchange of the defective product for a warranty replacement product; or to the granting of credit limited to the original cost of the defective product, and such repair, exchange or credit shall be the sole remedy available from tekmar, and, without limiting the foregoing in any way, tekmar is not responsible, in contract, tort or strict product liability, for any other losses, costs, expenses, inconveniences, or damages, whether direct, indirect, special, secondary, incidental or consequential, arising from ownership or use of the product, or from defects in workmanship or materials, including any liability for fundamental breach of contract.

The pass-through Limited Warranty applies only to those defective Products returned to tekmar during the warranty period. This Limited Warranty does not cover the cost of the parts or labor to remove or transport the defective Product, or to reinstall the repaired or replacement Product, all such costs and expenses being subject to Purchaser's agreement and warranty with its customers.

Any representations or warranties about the Products made by Purchaser to its customers which are different from or in excess of the tekmar Limited Warranty are the Purchaser's sole responsibility and obligation. Purchaser shall indemnify and hold tekmar harmless from and against any and all claims, liabilities and damages of any kind or nature which arise out of or are related to any such representations or warranties by Purchaser to its customers.

The pass-through Limited Warranty does not apply if the returned Product has been damaged by negligence by persons other than tekmar, accident, fire, Act of God, abuse or misuse; or has been damaged by modifications, alterations or attachments made subsequent to purchase which have not been authorized by tekmar; or if the Product was not installed in compliance with tekmar's instructions and / or the local codes and ordinances; or if due to defective installation of the Product; or if the Product was not used in compliance with tekmar's instructions.

THIS WARRANTY IS IN LIEU OF ALL OTHER WARRANTIES, EXPRESS OR IMPLIED, WHICH THE GOVERNING LAW ALLOWS PARTIES TO CONTRACTUALLY EXCLUDE, INCLUDING, WITHOUT LIMITATION, IMPLIED WARRANTIES OF MERCHANTABILITY AND FITNESS FOR A PARTICULAR PURPOSE, DURABILITY OR DESCRIPTION OF THE PRODUCT, ITS NON-INFRINGEMENT OF ANY RELEVANT PATENTS OR TRADEMARKS, AND ITS COMPLIANCE WITH OR NON-VIOLATION OF ANY APPLICABLE ENVIRONMENTAL, HEALTH OR SAFETY LEGISLATION; THE TERM OF ANY OTHER WARRANTY NOT HEREBY CONTRACTUALLY EXCLUDED IS LIMITED SUCH THAT IT SHALL NOT EXTEND BEYOND TWENTY-FOUR (24) MONTHS FROM THE PRODUCTION DATE, TO THE EXTENT THAT SUCH LIMITATION IS ALLOWED BY THE GOVERNING LAW.

Product Warranty Return Procedure All Products that are believed to have defects in workmanship or materials must be returned, together with a written description of the defect, to the tekmar Representative assigned to the territory in which such Product is located. If tekmar receives an inquiry from someone other than a tekmar Representative, including an inquiry from Purchaser (if not a tekmar Representative) or Purchaser's customers, regarding a potential warranty claim, tekmar's sole obligation shall be to provide the address and other contact information regarding the appropriate Representative.



tekmar Control Systems Ltd., Canada
tekmar Control Systems, Inc., U.S.A.
Head Office: 5100 Silver Star Road
Vernon, B.C. Canada V1B 3K4
(250) 545-7749 Fax. (250) 545-0650
Web Site: www.tekmarcontrols.com

Product design, software and literature
are Copyright © 2010 by:
tekmar Control Systems Ltd. and tekmar
Control Systems, Inc.