

**tekmar**<sup>®</sup>

tekmarNet<sup>®</sup> 2 Thermostat 530

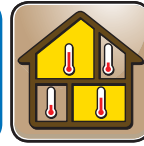

Zoning

**D530**

12/11

Replaces:08/10

## Installation & Operation Manual

### Introduction

The tekmarNet<sup>®</sup> 2 Thermostat 530 provides operation for:

- One Stage Heat
- One Stage Cool
- One Fan

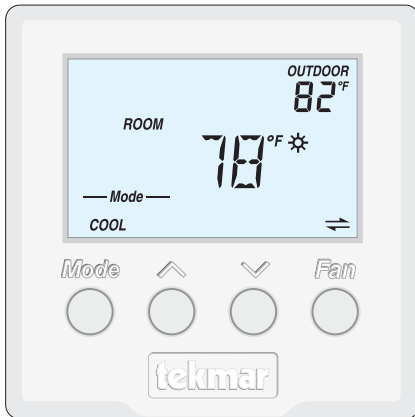

### Features

- Zone Synchronization
- Zone Post Purge
- Intelligent setback (Timer 033)
- One touch overrides (with optional User Switch)
- Auto Heating Cycle
- Cooling Interlock
- tekmarNet<sup>®</sup> 2 communication compatible
- Requires 2 wires
- One stage heat, cool, and fan
- Pulse Width Modulation
- CSA C US Approved for use in USA and Canada
- Outdoor temperature display
- Air Group master
- Backlight
- Freeze Protection
- Equipment Exercising
- Auto heat-cool switchover
- Room Temperature Limiting
- Hydronic Cooling
- Supports Radiant Floor Cooling

### Note

- tN2 Zone Manager, Expansion Module, Wiring Center or House Control required for operation

## Table of Contents

Getting Started .....	2	Settings .....	10-17
Installation .....	2	Sequence of Operation.....	18
Caution.....	2	Heating Operation .....	18
Preparation.....	2	Cooling Operation .....	19
Removing The Thermostat Base...	3	Floor Cooling.....	20
Mounting The Thermostat Base....	3	Fan Operation .....	21
Thermostat Wiring.....	4	Schedules .....	22
Testing the Thermostat Wiring .....	5	Scenes (System Override) .....	22
Mounting the Thermostat .....	6	Troubleshooting .....	23
Cleaning the Thermostat.....	6	Error Messages.....	23-24
Switch Settings .....	7	Frequently Asked Questions .....	25
User Interface.....	8	Job Record.....	26
Display.....	8	Technical Data.....	27
Symbols Description .....	8	Limited Warranty and Product	
Button Operation .....	9	Return Procedure .....	28

## Getting Started

Congratulations on the purchase of your new tekmar thermostat.

This manual will step through the complete installation, programming and sequence of operation for this control. At the back, there are tips for control and system troubleshooting.

## Installation

### Caution

Improper installation and operation of this control could result in damage to the equipment and possibly even personal injury or death. It is your responsibility to ensure that this control is safely installed according to all applicable codes and standards. This electronic control is not intended for use as a primary limit control. Other controls that are intended and certified as safety limits must be placed into the control circuit.

### Preparation

#### Tools Required

- tekmar or jeweller screwdriver
- Wire Stripper
- Phillips head screwdriver

#### Materials Required

- 2, #6 x 1" Wood Screws
- 18 AWG LVT Solid Wire (Low Voltage Connections)
- Optional Adapter Plate 007 (for installation on 2" x 4" gang box)

## Installation Location

Choose the placement of the thermostats early in the construction process to enable proper wiring during rough-in.

Consider the following:

- Interior Wall.
- Keep dry. Avoid potential leakage onto the control.
- Relative Humidity max 80% up to 88°F (31°C) decreasing linearly to 50% RH at 104°F (40°C). Non-condensing environment.
- No exposure to extreme temperatures beyond 36-122°F (2-50°C).
- No draft, direct sun, or other cause for inaccurate temperature readings.
- Away from equipment, appliances, or other sources of electrical interference.
- Easy access for wiring, viewing, and adjusting the display screen.
- Approximately 5 feet (1.5 m) off the finished floor.
- The maximum length of wire is 1000 feet (300 m).
- Strip wire to 3/8" (10 mm) for all terminal connections.
- Use standard 18 AWG wire for the tN2 connections.

## Removing The Thermostat Base

To remove the thermostat base:

- Place a small slot screwdriver or similar tool into the slot located on the top of the thermostat.
- While pushing down against the plastic tab, pull the thermostat away from the thermostat's base.

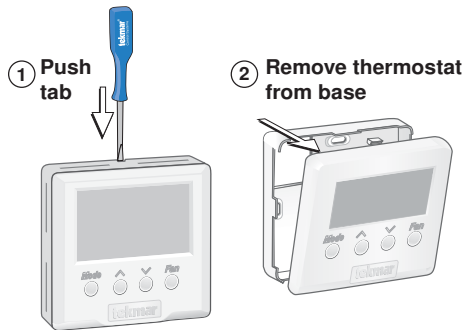

## Mounting The Thermostat Base

If a single gang switch box is used, an Adaptor Plate 007 is required to mount the thermostat to the box.

- Fasten the base of the thermostat to the adaptor plate.
- Feed the wiring through the openings in the back of the adaptor plate and thermostat.
- Use the upper and lower screw holes to fasten the adaptor plate to the box.

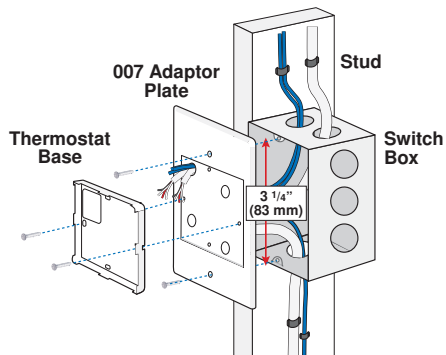

Mounted on switch box

If a switch box was not used, mount the thermostat directly to the wall.

- Feed the wiring through the openings in the back of the thermostat.
- Use screws in the screw holes to fasten the thermostat to the wall. At least one of the screws should enter a wall stud or similar rigid material.

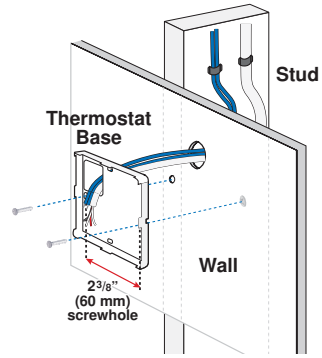

**Mounted on wallboard**

## Thermostat Wiring

The thermostat operates a single heating system zone together with a cooling system and fan.

Power and communication are provided to the thermostat by connecting the tN2 terminals on the thermostat to the tN2 terminals on a tN2 Wiring Center, House Control, Zone Manager or Expansion Module. tN2 terminals are not polarity sensitive.

Connect the Rc, Y and G terminals on the thermostat to the R, Y and G terminals on the cooling equipment.

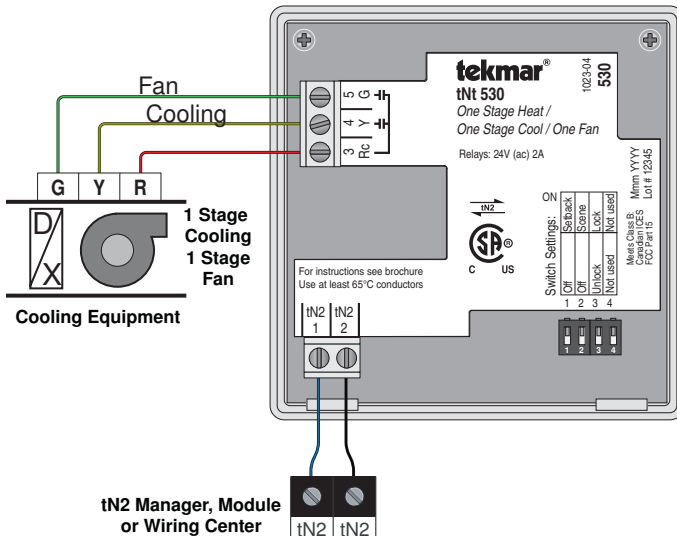

tekmarNet® communication allows for cooling operation from rooms where only 2 conductor wire is available. This requires a Zone Manager 334 or Zone Expansion Module 324 directly wired to the cooling equipment. Power and communication are provided to the 530 thermostat from tN2 terminals on the 334 or 324.

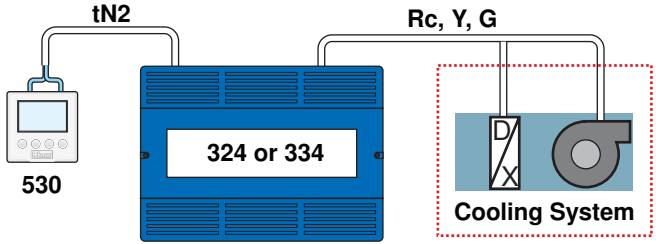

## Testing the Thermostat Wiring

### Testing the Power

If the thermostat display turns on, this indicates that the thermostat is operating correctly and there are no electrical issues. In the event that the display is off, or the display is cycling on and off:

1. Remove the tN2 wires from the thermostat.
2. Use an electrical meter to measure DC voltage between the tN2 terminals.
  - If the DC voltage is 0 V (dc) for 20 seconds, then there is an open or short circuit in the tN2 wires.
  - If the DC voltage is 0 V (dc) for 10 seconds and then is 23 to 24 V (dc) for 5 seconds, this indicates the wiring is correct.
3. Connect the thermostat to the tN2 wires connected to a zone on a House Control, Wiring Center, or Zone Manager.
4. If the thermostat display is off, or is cycling on and off, move the thermostat to the next available zone on the House Control, Wiring Center, or Zone Manager.
  - If the thermostat display remains permanently on, there may be a fault with the previously tried zone on the House Control, Wiring Center, or Zone Manager.
  - If the thermostat display continues to be off, or is cycling on and off, there may be a fault on the thermostat.

If a fault is suspected, contact your tekmar sales representative for assistance.

### Testing the Heat Zone Output

1. Press the Mode button to set the mode to Heat.
2. Press the  $\wedge$  button and set the heating temperature above the current room temperature. Make sure the display does not show "WWSD".
3. When the H1 symbol appears on the display, use an electrical meter to check for voltage on the House Control, Wiring Center, or Zone Manager relay. The voltage is 24 V (ac) for zone valves, and 120 V (ac) for zone pumps when operating correctly.

## Testing the Cooling Contact

1. Press the Mode button to set the mode to Cool.
2. Press the **▼** button and set the cooling temperature below the current room temperature.
3. When the C1 symbol appears on the display, use an electrical meter to check for continuity on the Rc and Y terminals. If continuity is present, the relay is operating correctly. If continuity is not present, the thermostat has malfunctioned.

## Testing the Fan Contact

1. Press the Fan button to set the Fan to On.
2. When the Fan symbol appears, use an electrical meter to check for continuity on the Rc and G terminals. If continuity is present, the relay is operating correctly. If continuity is not present, the thermostat has malfunctioned.

## Mounting the Thermostat

To place the thermostat back on the mounting base:

- Place thermostat bottom tabs on matching mounting base notches.
- Pivot top of the thermostat towards wall, ensuring wires clear obstructions.
- The top clasp makes a clicking sound when properly closed.

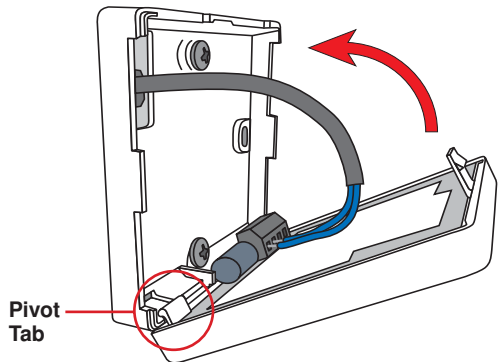

## Cleaning the Thermostat

The thermostat's exterior can be cleaned using a damp cloth. Moisten the cloth with water and wring out prior to wiping the control. Do not use solvents or cleaning solutions.

# Switch Settings

Switches are set to “On” position from the factory, and do not require changing for most applications.

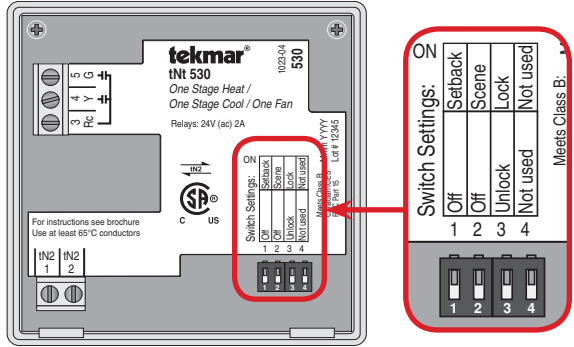

## Switch Position Action

Switch Position	Action
1	ON <b>SETBACK</b> The thermostat follows a programmable setback schedule as a schedule member if available. Requires the installation of a Timer 033 to use this feature.
	OFF <b>OFF</b> The thermostat does not follow a programmable setback schedule.
2	ON <b>SCENE</b> The thermostat responds to changes in the scene (system wide manual overrides). Requires the installation of a User Switch 479 to use this feature.
	OFF <b>OFF</b> The thermostat does not respond to scenes.
3	ON <b>LOCK ACCESS LEVEL</b> Locked to ‘User’ access level. Set to Lock when installation completed.
	OFF <b>UNLOCK ACCESS LEVEL</b> Unlock to allow ‘User’ and “Installer” access level. Set to Unlock during installation process. tekmarNet® reset control must also be set to Unlocked (Installer access level).
4	ON Not used
	OFF Not used

# User Interface

## Display

### MAIN DISPLAY      SECONDARY DISPLAY

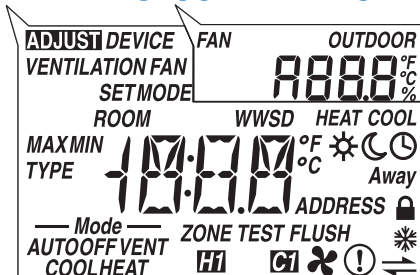

Switch between Heat, Cool, Auto and Off modes

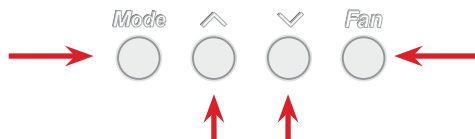

Switch between Auto, On and % Fan operation

Adjust the current temperature or displayed setting up or down

## Symbols Description

	<b>HEAT</b> Heat is turned on.		<b>CLOCK</b> Operating on a programmable schedule.
	<b>COOL</b> Cooling is turned on.		<b>LOCK</b> Locked to 'User' access level.
	<b>FAN</b> Fan is turned on.	<b>Away</b>	Operating at the <i>Away</i> scene temperature.
	<b>SUN</b> Operating at the occupied (day) temperature.		<b>tekmarNet®</b> Communication is present.
	<b>MOON</b> Operating at the unoccupied (night) temperature.		<b>WARNING SYMBOL</b> Indicates an error is present.
	<b>AIR GROUP MASTER</b> Thermostat operates the cooling for a group of thermostats.	<b>WWSH</b>	<b>WARM WEATHER SHUT DOWN</b> The heating system has been shut off for the summer.



## Button Operation

### Mode

The Mode button selects between Auto, Cool, Heat, and Off.

**Heat Mode:** The heating system operates to maintain the Set Room Heat temperature.

**Cool Mode:** The cooling system operates to maintain the Set Room Cool temperature.

**Auto Mode:** The heating system operates to maintain the Set Room Heat temperature. Likewise the cooling system operates to maintain the Set Room Cool temperature. The thermostat will prevent the Set Room Heat and the Set Room Cool settings from getting closer than 3°F (1.5°C).

To switch from heating to cooling, the heat must be off for at least a 30 minute interlock period and the actual Room temperature must be at least 3°F (1.5°C) above the Set Room Heat temperature.

To switch from cooling to heating, the cooling must be off for at least a 30 minute interlock period and the Room temperature must be at least 3°F (1.5°C) below the Set Room Cool temperature. Cooling has priority over heating.

**Off Mode:** The heating and cooling are shut off except heating for freeze protection.

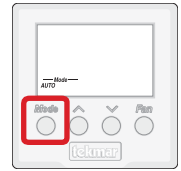

### Room $\wedge$ or $\vee$ Temperature

Press the  $\wedge$  or the  $\vee$  button to select the room temperature. The display indicates whether the "HEAT" or the "COOL" temperature is being changed.

If in Auto mode, press the Mode button to toggle between Heat or Cool temperature adjustment.

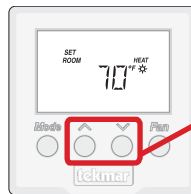

Use the  $\wedge$  or  $\vee$  button to adjust temperature.

### Fan

The fan button manually turns the fan on or off.

**Auto:** Fan is usually off but can operate with heating or cooling.

**On:** Fan is on all the time.



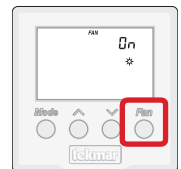

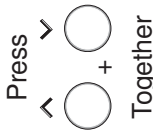

**10 to 90%:** Fan operates a minimum of this percentage each hour.



## Settings (1 of 8)





- Press and hold down both the ▲ and ▼ buttons for 2 seconds to change from one step to the next.
- Release both buttons once the step has been reached.
- Press the ▲ or the ▼ button to change the setting, if available.
- Press and hold down both the ▲ and ▼ buttons for 2 seconds to go to the next step, OR
- After 10 seconds of no button activity, the display goes back to normal operation.
- **Note:** Set switch setting #3 and tekmarNet® system control to Unlock to change Access level to Installer.

Display	Range	Access	Description	Set to
ADJUST SET ROOM HEAT OF  70	40 to 95°F (4.5 to 35.0°C) Default = 70°F (21.0°C)	Installer User	<b>SET ROOM HEAT</b>  Set the room heating temperature while in the  event.	
ADJUST SET ROOM HEAT OF  65	40 to 95°F (4.5 to 35.0°C) Default = 65°F (18.5°C)	Installer User	<b>SET ROOM HEAT</b>  Set the room heating temperature while in the  event.	
ADJUST SET ROOM HEAT OF  62 <span style="float: right;">Away</span>	40 to 95°F (4.5 to 35.0°C) Default = 62°F (16.5°C)	Installer	<b>SET ROOM HEAT AWAY</b> Set the room heating temperature while in the <i>Away</i> scene.	

Continued on next page.

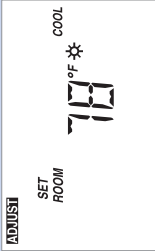
## Settings (2 of 8)

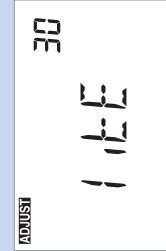

Display	Range	Access	Description	Set to
	50 to 100° F (10.0 to 38.0 °C) Default = 78° F (25.5° C)	Installer User	<b>SET ROOM COOL ☀</b> Set the room cooling temperature while in the ☀ event.	
	50 to 100° F (10.0 to 38.0 °C) Default = 85° F (29.5° C)	Installer User	<b>SET ROOM COOL ☾</b> Set the room cooling temperature while in the ☾ event.	
	50 to 100° F (10 to 38.0° C) Default = 85° F (29.5° C)	Installer	<b>SET ROOM COOL AWAY</b> Set the room cooling temperature while in the Away scene.	
	Off, 30 sec, On, On + ☀ Default = 30 sec	Installer User	<b>BACKLIGHT</b> Select the backlight operation. Off = Permanently Off 30 = Temporary on for 30 seconds On = Permanently On On + ☀ = On during ☀ and off during ☾	

Continued on next page.

Settings (3 of 8)		Range	Access	Description	Set to
Display					
		°F or °C Default = °F	Installer User	<b>TEMPERATURE UNITS</b> Press the <b>^</b> or the <b>v</b> button to change from °F to °C and vice versa.	
		Device Type with Software Version, Address	Installer User	<b>DEVICE TYPE</b> Display alternates between the Device Type (large number) with Software Version (upper right corner) and the thermostat address.	
		40 to 95°F (4.5 to 35.0°C) Default = 85°F (29.5°C)	Installer	<b>MAXIMUM SET ROOM HEAT</b> ☼ Set the maximum room heating limit while in the ☼ event.	
		40 to 95°F (4.5 to 35.0°C) Default = 85°F (29.5°C)	Installer	<b>MAXIMUM SET ROOM HEAT</b> ☾ Set the maximum room heating limit while in the ☾ event.	
		40 to 95°F (4.5 to 35.0°C) Default = 45°F (7.0°C)	Installer	<b>MINIMUM SET ROOM HEAT</b> Set the minimum room heating limit.	

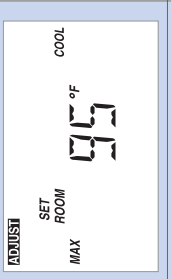
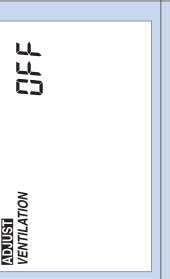

Continued on next page.

## Settings (4 of 8)

Display	Range	Access	Description	Set to
 <p>ADJUST SET ROOM MIN COOL 60 60°F</p>	50 to 100°F (10 to 38.0°C) Default = 60°F (15.5°C)	Installer	<b>MINIMUM SET ROOM COOL</b> Set the minimum room cooling limit.	
 <p>ADJUST SET ROOM MAX COOL 95 95°F</p>	50 to 100°F (10.0 to 38.0°C) Default = 95°F (35.0°C)	Installer	<b>MAXIMUM SET ROOM COOL</b> Set the maximum room cool limit.	
 <p>ADJUST VENTILATION OFF</p>	OFF, On Default = OFF	Installer	<b>VENTILATION</b> Select whether or not ventilation is required. Setting to on allows the fan to be operated in 10% increments every hour to circulate air in the building.	
 <p>ADJUST FAN MODE 1</p>	0, 1, 2, 3 Default = 1	Installer	<b>FAN MODE</b> Select how the fan should operate together with heating and cooling. 0 = Manual operation only 1 = Operate fan with cooling only 2 = Operate fan with heating and cooling 3 = Operate fan with heating only	

Continued on next page.

## Settings (5 of 8)

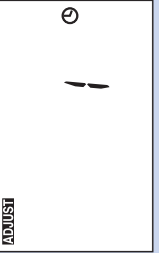
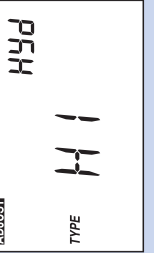
Display	Range	Access	Description	Set to
	Auto, 10 to 90%, On Default = Auto	Installer User	<b>FAN *</b> Set the minimum percentage the fan should operate while in the * event. This provides ventilation for the building. Each 10% is 6 minutes per hour. Available when: <ul style="list-style-type: none"> <li>• Ventilation is set to On.</li> </ul>	
	Auto, 10 to 90%, On Default = Auto	Installer User	<b>FAN ☾</b> Set the minimum percentage the fan should operate while in the ☾ event. This provides ventilation for the building. Each 10% is 6 minutes per hour. Available when: <ul style="list-style-type: none"> <li>• Ventilation is set to On.</li> </ul>	
	1, 2, 3, 4 Default = 1	Installer	<b>SCHEDULE</b> Thermostat can follow schedule master 1, 2, 3, or 4. Available when: <ul style="list-style-type: none"> <li>• Switch setting 1 is set to Setback (On Position).</li> </ul>	
	Hyd (Hydronic) or Oth (Other) Default = Hydronic	Installer	<b>HEATING TERMINAL TYPE</b> Select if the heating for this zone is hydronic or non-hydronic (other). Available when: <ul style="list-style-type: none"> <li>• A reset control is present on the tekmarNet® system.</li> </ul>	

Continued on next page.

# Settings (6 of 8)

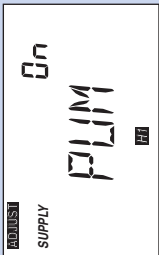
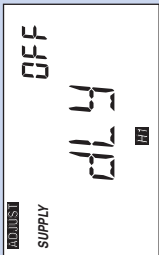
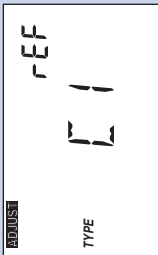
Display	Range	Access	Description	Set to
	<p>OFF or On Default = On</p>	<p>Installer</p>	<p><b>HEAT SUPPLY PUMP</b> During heating, select whether or not the system supply pump should turn on or be off to allow a zone group pump per manifold. Available when:</p> <ul style="list-style-type: none"> <li>A reset control is present on the tekmarNet® system AND Heating terminal type is set to Hydronic.</li> </ul>	
	<p>OFF or On Default = OFF</p>	<p>Installer</p>	<p><b>HEAT SUPPLY PUMP DELAY</b> During heating, select whether or not the system supply pump should be delayed by 3 minutes before coming on (for thermal motor or wax actuator). Available when:</p> <ul style="list-style-type: none"> <li>A reset control is present on the tekmarNet® system AND Heating terminal type is set to Hydronic.</li> </ul>	
	<p>rEF, Coil, H1 Default = rEF</p>	<p>Installer</p>	<p><b>COOL TERMINAL TYPE</b> Select the type of cooling system operated. rEF = DX refrigerant coil Coil = Hydronic coil H1 = Hydronic cooling using the heating terminal unit Coil and H1 are available when:</p> <ul style="list-style-type: none"> <li>A heat pump or chiller tekmarNet® system control is present.</li> </ul>	

Continued on next page.

## Settings (7 of 8)

Display	Range	Access	Description	Set to
<p>The LCD display shows the word 'ADJUST' in a small box at the top left, followed by 'SUPPLY' on the next line, 'PUMP' in large characters on the third line, and 'On' on the fourth line. A small square icon is visible at the bottom right of the display area.</p>	<p>OFF or On Default = On</p>	<p>Installer</p>	<p><b>COOL SUPPLY PUMP</b> During cooling, select whether or not the system supply pump should turn on or be off to allow a zone group pump per manifold. Available when:  <ul style="list-style-type: none"> <li>• A reset control is present on the tekmarNet® system AND Cool terminal type is set to Coil.</li> </ul> </p>	
<p>The LCD display shows the word 'ADJUST' in a small box at the top left, followed by 'SUPPLY' on the next line, 'DELAY' in large characters on the third line, and 'OFF' on the fourth line. A small square icon is visible at the bottom right of the display area.</p>	<p>OFF or On Default = OFF</p>	<p>Installer</p>	<p><b>COOL SUPPLY PUMP DELAY</b> During cooling, select whether or not the system supply pump should be delayed by 3 minutes before coming on (for thermal motor or wax actuator). Available when:  <ul style="list-style-type: none"> <li>• A reset control is present on the tekmarNet® system AND Cool terminal type is set to Coil.</li> </ul> </p>	
<p>The LCD display shows the word 'ADJUST' in a small box at the top left, followed by 'SUPPLY' on the next line, 'SYCN' in large characters on the third line, and 'Synchronize' on the fourth line. A small square icon is visible at the bottom right of the display area.</p>	<p>Auto, SYn(Synchronize) Default = Synchronize</p>	<p>Installer</p>	<p><b>HEAT CYCLES PER HOUR</b> Select either Auto cycle or Synchronize with other thermostats on the tekmarNet® system. Choose Synchronize when zone heated using a boiler. Choose Auto when zone is non-hydrionic heating. Available when:  <ul style="list-style-type: none"> <li>• No reset control on the tekmarNet® system.</li> </ul> </p>	

Continued on next page.



## Settings (8 of 8)

Display	Range	Access	Description	Set to
<p>The LCD display shows 'AIR b' at the top and 'OFF' in large characters below it.</p>	OFF, 1 to 16	Installer	<p><b>AIR GROUP</b></p> <p>Select if this thermostat should be an air group master. Select off if the thermostat is not an air group master. Select 1 through 16 to select the air group number. Available when:</p> <ul style="list-style-type: none"> <li>The thermostat is connected to other thermostats using tekmarNet®.</li> </ul>	
<p>The LCD display shows 'Auto' at the top and 'b:01 ADDRESS' in large characters below it.</p>	01 to 24 (no reset control), b:01 to b:24 (reset control - boiler), 1:01 to 1:24 (reset control - mixing)	Installer	<p><b>tekmarNet® ADDRESS</b></p> <p>The address is shown in the large number field. "Auto" is shown in the upper number field when using automatic addressing.</p> <p>Press the <b>▲</b> or the <b>▼</b> button to manually select an address.</p> <p>The address can be returned to automatic "Auto" addressing when address set above 24.</p>	
<p>The LCD display shows 'FLOOR' on the left, 'OFF' in large characters in the center, and 'COOL' on the right.</p>	OFF or On Default = OFF	Installer	<p><b>FLOOR COOLING</b></p> <p>Select if the thermostat should operate the heating relay W for radiant floor cooling.</p> <p>Available when:</p> <ul style="list-style-type: none"> <li>Connected to a tekmarNet® heat pump or chiller system control AND heating terminal type is set to Hydronic AND cooling terminal type is set to rEF or COIL.</li> </ul>	
<p>The LCD display shows 'ESC' in large characters.</p>	None	Installer User	<p><b>ESCAPE</b></p> <p>Press the <b>▲</b> or the <b>▼</b> button to return to normal operation.</p>	

# Sequence of Operation

## Heating Operation

## Section A

The thermostat operates the heating system to maintain the Set Room Heat temperature. The H1 symbol is shown on the display when the thermostat is heating. The heat can cycle on and off within +/- 1.5°F (1°C) of the Set Room Heat temperature.

### Freeze Protection

The thermostat operates the heat whenever the room temperature falls below 40°F (4.5°C), regardless of the thermostat mode.

### Heat Terminal Unit

When the thermostat is connected to a tekmarNet® reset control, the heat source can be either hydronic or non-hydronic.

When the Heat Terminal is set to Hydronic, the thermostat uses indoor temperature feedback to fine tune the water temperature and also synchronizes the start of a heating cycle so that all thermostats start heating at the same time. This reduces cycling on the boiler.

When the Heat Terminal is set to Other, the thermostat does not use indoor temperature feedback. This allows the thermostat to operate non-hydronic heating systems (example: furnace, electric baseboard, or electric fan coil), while remaining connected to the tekmarNet® system.

### Exercising

When connected to a tekmarNet® reset control, and the heating terminal unit is set to hydronic, the thermostat exercises the heat relay for 10 seconds every 3 days. Exercising helps prevent zone valves or zone pumps from failing due to precipitate buildup. During exercising, the thermostat shows “TEST” on the display.

### Flushing

The flushing feature is for open-loop systems that use a domestic hot water tank as a heat source. Flushing ensures that fresh potable water is circulated through the system once each day. If the thermostat is connected to a tekmarNet® reset control with the Flushing feature turned on, the thermostat display will display the “FLUSH” icon for the duration of the flushing operation.

### Hydronic System Supply Pump

When connected to a tekmarNet® system control, the thermostat's Heat Supply Pump setting affects how the primary pump or mix pump on the system control operates. When connected to the boiler bus, the boiler system or primary pump is operated. When connected to the mix bus, the mix system pump is operated.

If the thermostat operates a motorized or thermal motor zone valve, the Heat Supply Pump setting should be set to On.

If the thermostat operates a thermal motor (wax actuator) zone valve, set the Heat Supply Pump Delay setting to On. This provides a three minute delay to allow the zone valve to open before the primary or mix pump is turned on.

In special applications with multiple zoning manifolds, the Heat Supply Pump setting can be set to Off. This allows a Zone Group Pump located on the Zone Manager, or Wiring Center to operate the pump for the manifold.

### DHW Tank Priority

When a tekmarNet® reset control is heating an indirect Domestic Hot Water (DHW) tank, the thermostat may shut off the heating zones to allow the DHW tank to recover quickly. This is determined by the DHW priority of the tekmarNet® reset control.

### Warm Weather Shut Down

When the outdoor air temperature exceeds the Warm Weather Shut Down (WWSD) setting on the tekmarNet® reset control, the heating system is shut off.

## Cooling Operation

## Section B

The thermostat operates the cooling system to maintain the Set Room Cool temperature. The C1 symbol is shown on the display when the thermostat is cooling. The cooling can cycle on and off within +/- 1.5°F (1°C) of the Set Room Cool temperature.

The cooling system has a fixed minimum on time of 2 minutes and a minimum off time of 5 minutes in order to prevent cooling equipment short cycling.

### Air Groups

In order to prevent heating and cooling at the same time, this thermostat can operate together with other thermostats on a tekmarNet® system to form an air group. There can be up to 16 different air groups on the same HVAC system. When this thermostat is set as the Air Group master, it operates the cooling equipment for the group. Other thermostats can be set to become members of the same air group. When the cooling is turned on, all air group member thermostats ensure the heating is off. When operating as an air group, the air temperature readings of all the air group member thermostats are displayed on the master as an average.

The air group average temperature is shown as the “Room” temperature while the mode is set to Cool, or the mode is set to Auto and the thermostat is allowing cooling operation. In all other modes, the air group master thermostat measures and displays the built-in “local” temperature sensor measurement.

Fluctuations in the displayed “Room” temperature may occur during automatic mode switch over when the display changes from using the local temperature for heating to using the air group average temperature for cooling.

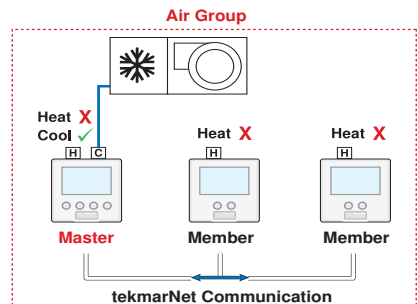

## Hydronic Cooling

The thermostat has the option to support hydronic cooling using a fan coil or a chilled beam when connected to a heat pump or chiller tekmarNet® system control.

When operating a chilled beam or a fan coil that uses chilled water for cooling but does not use hot water for heating, then the Cool Terminal Type should be set to Coil. The thermostat activates the Y terminal and also provides a cooling call to the heat pump or chiller control through the tekmarNet® communication.

When operating a fan coil that uses both hot and chilled water, then the Cool Terminal Type should be set to H1. The thermostat activates both the Y terminal and the heating terminal device (zone valve or zone pump), as well as provides a cooling call to the heat pump or chiller control through the tekmarNet® communication.

## Hydronic System Supply Pump

When connected to a tekmarNet® system control, the thermostat's Cool Pump setting affects how the primary pump or mix pump on the system control operates during cooling operation. When connected to the boiler bus, the boiler system or primary pump is operated. When connected to the mix bus, the mix system pump is operated.

If the thermostat operates a motorized or thermal motor zone valve, the Cool Supply Pump setting should be set to On.

If the thermostat operates a thermal motor (wax actuator) zone valve, set the Cool Supply Pump Delay setting to On. This provides a three minute delay to allow the zone valve to open before the primary or mix pump is turned on.

In special applications with multiple zoning manifolds, the Cool Supply Pump setting can be set to Off. This allows a Zone Group Pump located on the Zone Manager, or Wiring Center to operate the pump for the manifold.

## Floor Cooling

## Section C

The thermostat has the option to support radiant floor cooling when connected to a heat pump control using tekmarNet® communication. The heating terminal unit type must be set to be hydronic (HYD), the floor cooling setting must be set to On and the heating system must be in Warm Weather Shut Down (WWSD). When the heat pump system control operates in cooling mode, all thermostats set for floor cooling on the tekmarNet® bus all activate the first stage heating contact (H1) at the same time to allow chilled water into the system. The thermostat continues to operate the cooling until either the room temperature reaches the Set Heat temperature plus 3°F (Set Heat+1.5°C) or reaches a minimum temperature of 74°F. If only a floor sensor is installed, the floor cooling setpoint is 67°F (19.5°C).

The thermostat normally operates the fan together with the heating and cooling systems. This is determined by the Fan Mode setting in the Adjust menu.

Fan Mode	The fan operates with...
0	Not With Heating Nor Cooling (Only with fan button)
1	Cooling Only
2	Heating and Cooling
3	Heating Only

The fan relay includes a post purge feature. After the heating is shut off, the fan continues to operate for 30 seconds. After the cooling is shut off, the fan continues to operate for 10 seconds.

The user can also select to operate the fan manually by pressing the Fan button. This allows the user to choose between Auto and On. "Auto" allows the fan to operate together with heating or cooling but normally the fan is off. "On" forces the fan to operate continuously.

The fan button is inactive when the Fan Mode is 0 and Ventilation is set to Off.

### **Ventilation Fan**

---

In order to provide ventilation to the building, the fan can also operate for additional time beyond what is required for the heating and cooling systems. Ventilation allows the user to select the fan to operate for a minimum percentage out of each hour. Options are 10 to 90%, in 10% (6 minutes per hour) increments, as well as Auto and On. This is available when the Ventilation setting in the Adjust menu is set to On.

Once Ventilation is set to On, the Fan minimum run time percentage during the ☼ and ☾ events can be set so that the fan can operate on a schedule and/or together with scenes.

Lowering the room temperature setting reduces the amount of fuel required to heat the building resulting in energy savings. Likewise, raising the cooling temperature results in energy savings.

This thermostat can follow a programmable schedule in order to automatically lower the room temperature setting. A schedule master such as a Timer 033 is required in order to gain programmable schedule functionality.

When operating on a programmable schedule, a ☰ symbol is shown, as well as a ☀ or a ☾. The ☀ or ☾ indicates the current operating temperature.

If a ☰ symbol does not appear, there is no schedule available.

Display	Action
☀	Occupied temperature. No schedule.
☾	Unoccupied temperature. No schedule.
☀ ☰	Programmable schedule at occupied temperature.
☾ ☰	Programmable schedule at unoccupied temperature.

When a programmable schedule is selected, there is a time delay for the temperature to change from the ☾ temperature to the ☀ temperature.

The thermostat uses Optimum Start to predict the heat up and cool off rate of the room. The optimum start feature allows the room to reach the set room ☀ temperature by the time set in the programmable schedule. This applies for both heating and cooling.

## Scenes (System Override)

## Section F



Scenes provide an easy way to save energy while away on vacation, or override a pre-set schedule when plans change. tekmarNet® devices such as a User Switch 479 provide scene adjustment.

This thermostat responds to the following scenes:

Scene	Display	Room Temperature Setting
1	☀ or ☀ ☰ or ☾ ☰	Follows programmable schedule or operates at the occupied ☀ temperature.
2	<b>Away</b>	Away temperature.
3	☾	Unoccupied ☾ temperature.

While in the *Away* scene, the room temperature cannot be changed using the ^ or v buttons. Change the scene from *Away* to ☀ or ☾ to change the temperature.

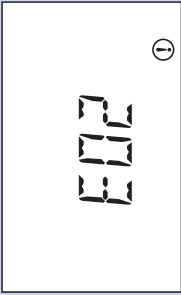
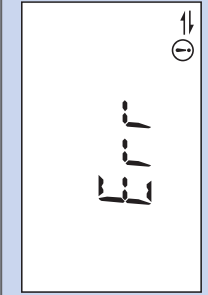
# Troubleshooting

Error Messages (1 of 2)	
Error Message	Description
	<p><b>CONTROL ERROR</b> The thermostat was unable to correctly read settings from memory and has reloaded the factory default settings. The thermostat does not operate the heating, cooling, or the fan while this error message is present. Error clears once all adjust menu settings in the Installer access level (unlocked) have been checked. Set thermostat's switch setting #3 to unlock and unlock the tekmarNet® system control. Then press and hold <b>▲</b> and <b>▼</b> buttons together for 2 seconds to enter the adjust menu. Continue until all settings have been reviewed.</p>
	<p><b>PORT ERROR</b> Thermostat has been connected to a tN2 Zone already in use by a 2-stage device. A 2-stage device requires two tN2 ports to operate. This device may be connected to one such port. Move the thermostat's tN2 wires to an unused tN2 port on the control.</p>
	<p><b>BUS ERROR</b> The tekmarNet®4 communication bus has either an open or a short circuit. The result is that there are no communications. Check for loose wires. Check for short circuits between the tN4 and C wires on the House Control, Wiring Center, or Zone Manager. Check for correct polarity between the C and R wires. Error clears automatically once wiring fault has been corrected. If the thermostat is intentionally removed from the tekmarNet®4 bus, press the <b>▲</b> and <b>▼</b> buttons together to clear the error message.</p>
	<p><b>DEVICE LIMIT</b> The number of devices on the tekmarNet® bus has exceeded 24. Devices include tekmarNet® Thermostats and Setpoint Controls. The device count must be lowered to 24 or less. If possible, move devices to other tekmarNet® buses. Error clears automatically once the number of devices on the tekmarNet® bus is at 24 or lower.</p>

## Error Messages (2 of 2)

### Error Message

### Description

#### ADDRESS ERROR

This thermostat and another device have been manually given the same tekmarNet® address. Error clears automatically once this thermostat is given a new manually set address or if the thermostat is set to automatic addressing.

Err  
ADDRESS  
①

#### ROOM SENSOR SHORT CIRCUIT

The built-in air temperature sensor has a short circuit fault. This error cannot be field repaired. Contact your wholesaler or tekmar sales representative for details on repair procedures.

ROOM/SENSOR  
SHR  
①

#### ROOM SENSOR OPEN CIRCUIT

The built-in air temperature sensor has an open circuit fault. This error cannot be field repaired. Contact your wholesaler or tekmar sales representative for details on repair procedures.

ROOM/SENSOR  
OPN  
①

#### AIR MASTER ERROR

There are two thermostats on the tekmarNet® system set as the same Air Group master. The cooling system will not operate while this error message is present. Error clears once this thermostat or the other thermostat's air group master number is changed to an unused air group number.

Err  
M5E  
COOL  
①



## Frequently Asked Questions

Symptom	Look for...	Corrective Action
No Heat	H1 Symbol	H1 symbol indicates heat is on. Check if zone valve or zone pump is operating.
	Flashing WWSD	Increase WWSD setting on tekmarNet® reset control.
	Flashing Away	Change User Switch to Normal scene 1.
	Mode Auto or Heat	Press Mode button to Auto or Heat mode.
No Cooling	C1 Symbol	C1 symbol indicates cooling is on. Check if cooling relay and cooling equipment are operating.
	Flashing Away	Change User Switch to Normal scene 1.
	Mode Auto or Cool	Press Mode button to Auto or Cool mode.
Heat or Cooling on yet Fan off	Fan symbol	Fan symbol indicates fan is on. Check if fan relay and fan equipment is operating.
	Fan set to Off	Ensure fan mode is set correctly.
Heat or cooling on before scheduled time		Optimum start “learns” the heat up and cool off rate of the room and starts the heating or cooling early so that the room is comfortable at the scheduled time.
Pressing ^ button does not increase temperature	Flashing Max	Installer can increase the Maximum Set Room Heat or Maximum Set Room Cool limits.
Pressing v button does not decrease temperature	Flashing Min	Installer can decrease the Minimum Set Room Heat or Minimum Set Room Cool limits.

## Job Record

Jobsite Location \_\_\_\_\_

Thermostat Location \_\_\_\_\_

Item	Setting	Item	Setting
Set Room Heat ☼		Fan Mode	
Set Room Heat ☾		Fan ☼	
Set Room Heat Away		Fan ☾	
Set Room Cool ☼		Schedule Member	
Set Room Cool ☾		Heat Terminal Type	
Set Room Cool Away		Heat Supply Pump	
Backlight		Heat Supply Pump Delay	
Units		Cool Terminal Type	
Max Set Room Heat ☼		Cool Supply Pump	
Max Set Room Heat ☾		Cool Supply Pump Delay	
Min Set Room Heat		Heat Cycles Per Hour	
Min Set Room Cool		Air Group	
Max Set Room Cool		tekmarNet® Address	
Ventilation		Floor Cooling	

## Technical Data

### **tekmarNet<sup>®</sup>2 Thermostat 530;** *One Stage Heat, One Stage Cool, One Fan*

Packaged weight	0.8 lb. (380 g)
Enclosure	NEMA 1, white PVC plastic
Dimensions	2-7/8" H x 2-7/8" W x 13/16" D (73 x 73 x 21 mm)
Approvals	CSA C US, meets Class B: ICES and FCC Part 15
Ambient conditions	Indoor use only, 36 to 122°F (2 to 50°C).
	RH max 80% up to 88°F (31°C) decreasing linearly to 50% RH at 104°F (40°C)
	Altitude 0 - 6560 feet (2000 m), Installation Category II, Pollution Category 2
Power supply	Provided by tekmarNet <sup>®</sup> 2 Control, 1.3 VA
Y and G Relays	24 V (ac) 2 A

## Limited Warranty and Product Return Procedure

**Limited Warranty** *The liability of tekmar under this warranty is limited. The Purchaser, by taking receipt of any tekmar product ("Product"), acknowledges the terms of the Limited Warranty in effect at the time of such Product sale and acknowledges that it has read and understands same.*

The tekmar Limited Warranty to the Purchaser on the Products sold hereunder is a manufacturer's pass-through warranty which the Purchaser is authorized to pass through to its customers. Under the Limited Warranty, each tekmar Product is warranted against defects in workmanship and materials if the Product is installed and used in compliance with tekmar's instructions, ordinary wear and tear excepted. The pass-through warranty period is for a period of twenty-four (24) months from the production date if the Product is not installed during that period, or twelve (12) months from the documented date of installation if installed within twenty-four (24) months from the production date.

The liability of tekmar under the Limited Warranty shall be limited to, at tekmar's sole discretion: the cost of parts and labor provided by tekmar to repair defects in materials and / or workmanship of the defective product; or to the exchange of the defective product for a warranty replacement product; or to the granting of credit limited to the original cost of the defective product, and such repair, exchange or credit shall be the sole remedy available from tekmar, and, without limiting the foregoing in any way, tekmar is not responsible, in contract, tort or strict product liability, for any other losses, costs, expenses, inconveniences, or damages, whether direct, indirect, special, secondary, incidental or consequential, arising from ownership or use of the product, or from defects in workmanship or materials, including any liability for fundamental breach of contract.

The pass-through Limited Warranty applies only to those defective Products returned to tekmar during the warranty period. This Limited Warranty does not cover the cost of the parts or labor to remove or transport the defective Product, or to reinstall the repaired or replacement Product, all such costs and expenses being subject to Purchaser's agreement and warranty with its customers.

Any representations or warranties about the Products made by Purchaser to its customers which are different from or in excess of the tekmar Limited Warranty are the Purchaser's sole responsibility and obligation. Purchaser shall indemnify and hold tekmar harmless from and against any and all claims, liabilities and damages of any kind or nature which arise out of or are related to any such representations or warranties by Purchaser to its customers.

The pass-through Limited Warranty does not apply if the returned Product has been damaged by negligence by persons other than tekmar, accident, fire, Act of God, abuse or misuse; or has been damaged by modifications, alterations or attachments made subsequent to purchase which have not been authorized by tekmar; or if the Product was not installed in compliance with tekmar's instructions and / or the local codes and ordinances; or if due to defective installation of the Product; or if the Product was not used in compliance with tekmar's instructions.

THIS WARRANTY IS IN LIEU OF ALL OTHER WARRANTIES, EXPRESS OR IMPLIED, WHICH THE GOVERNING LAW ALLOWS PARTIES TO CONTRACTUALLY EXCLUDE, INCLUDING, WITHOUT LIMITATION, IMPLIED WARRANTIES OF MERCHANTABILITY AND FITNESS FOR A PARTICULAR PURPOSE, DURABILITY OR DESCRIPTION OF THE PRODUCT, ITS NON-INFRINGEMENT OF ANY RELEVANT PATENTS OR TRADEMARKS, AND ITS COMPLIANCE WITH OR NON-VIOLATION OF ANY APPLICABLE ENVIRONMENTAL, HEALTH OR SAFETY LEGISLATION; THE TERM OF ANY OTHER WARRANTY NOT HEREBY CONTRACTUALLY EXCLUDED IS LIMITED SUCH THAT IT SHALL NOT EXTEND BEYOND TWENTY-FOUR (24) MONTHS FROM THE PRODUCTION DATE, TO THE EXTENT THAT SUCH LIMITATION IS ALLOWED BY THE GOVERNING LAW.

**Product Warranty Return Procedure** All Products that are believed to have defects in workmanship or materials must be returned, together with a written description of the defect, to the tekmar Representative assigned to the territory in which such Product is located. If tekmar receives an inquiry from someone other than a tekmar Representative, including an inquiry from Purchaser (if not a tekmar Representative) or Purchaser's customers, regarding a potential warranty claim, tekmar's sole obligation shall be to provide the address and other contact information regarding the appropriate Representative.



tekmar Control Systems Ltd., Canada  
tekmar Control Systems, Inc., U.S.A.  
**Head Office: 5100 Silver Star Road**  
**Vernon, B.C. Canada V1B 3K4**  
**(250) 545-7749 Fax. (250) 545-0650**  
Web Site: [www.tekmarcontrols.com](http://www.tekmarcontrols.com)

Product design, software and literature  
are Copyright © 2011 by:  
tekmar Control Systems Ltd. and tekmar  
Control Systems, Inc.