

tekmar® - Data Brochure

Thermostat 508 and 509

D 508

04/12

Replaces: 05/10

Table of Contents

Display / Keypad Operation.....	pg 1	Menus	pg 12-14
Display Symbols	pg 2	View Menu	pg 12
General	pg 2-3	Adjust Menu	pg 13
Sequence of Operation.....	pg 3-4	Schedule Menu	pg 14
Installation - Slab Sensor 079.....	pg 4-6	Error Messages	pg 14
Installation - Thermostats	pg 7-8	Technical Data	pg 15
Wiring Examples.....	pg 9-10	Warranty	pg 16
User Interface	pg 11		

This brochure is for Thermostats 508 and 509 (with sensor). The section on the 079 slab sensor installation is for the 509 only!

Display / Keypad Operation

The thermostat's display has four distinct fields. These fields are the **Menu** field, the **Item** field, the **Number** field and the **Status** field. The four buttons on the face of the thermostat are used to navigate through the menus and items to view and / or adjust the desired settings.

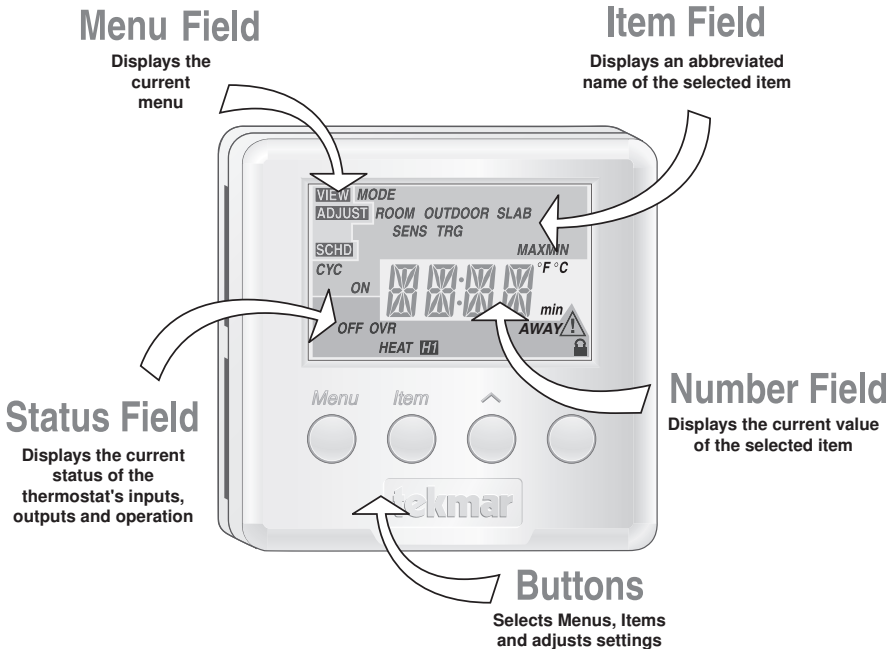

Display Symbols



Warning

Displays when an error exists.



Heat One

Displays when the heat contact is on.



Access Level

Displays when in the user access level.

General

CYCLES PER HOUR

The thermostat operation is based on cycles per hour. The number of cycles per hour is adjustable through the HEAT CYC setting in the *Adjust* menu. During each cycle that heating is required, the thermostat turns on the Heat relay for a calculated amount of time. This amount of time is the “ON time”. The ON time is calculated based on the requirements of the zone. If the zone requires more heating, the ON time is increased. If the zone requires less heating, the ON time is reduced.

In order to prevent short cycling of the heating relay, the thermostat ensures that the relay remains on or off for a minimum amount of time.

An AUTO CYC setting is available for the heating cycle. This setting allows the thermostat to determine the best number of cycles per hour that balances both temperature swings and equipment cycles.

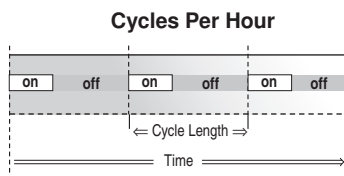

AUXILIARY SENSOR

The thermostat has a single built-in sensor to measure air temperature at the thermostat. In addition to the built-in sensor, the thermostat has terminals to connect one auxiliary sensor. This sensor can be either an indoor sensor, a slab sensor, or an outdoor sensor.

Indoor Sensor

An indoor sensor is used to measure the air temperature in the zone that the thermostat is controlling. The temperature being read by the indoor sensor is used in the calculations of the ON time for the relay in the thermostat. This setting is made through the *Adjust* menu of the thermostat. If the built-in sensor is set to ON and the auxiliary sensor is set to Indoor, the temperatures of the sensors are averaged and used to calculate the ON time of the relay.

Slab Sensor

A slab sensor is used to measure the slab temperature in the zone that the thermostat is controlling. The temperature being read by the slab sensor is used in the calculations of the ON time for the Heat relay and allows the thermostat to operate the slab between the slab minimum and slab maximum settings.

Outdoor Sensor

An outdoor sensor can be connected to the thermostat. The temperature measured by an outdoor sensor does not affect the ON time of the relay and is only used for display purposes.

ACCESS LEVELS

The 508 thermostat has two access levels. These access levels restrict the number of items available in the menus of the thermostat. The two access levels are User and Installer. This selection is made using the DIP switch located on the circuit board inside the thermostat.

Installer access level - allows the installer to adjust all of the settings in the thermostat including those required to match the thermostat to the mechanical system and the devices used.

User access level - allows the end user to adjust the temperatures used by the thermostat.

Set to **User** access level once installation and settings have been completed.

Note: DIP switch 2 is not used.

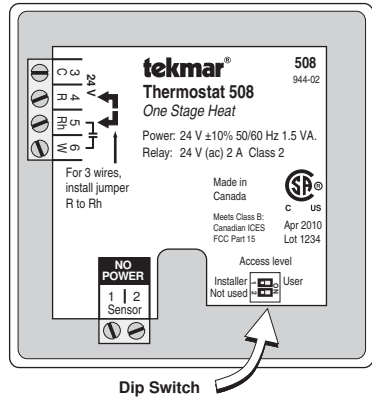

Sequence of Operation

AIR SENSOR(S) ONLY OPERATION

When operating with only an air sensor, the ON time for the Heat relay is calculated to satisfy the requirements of the air sensor.

SLAB SENSOR ONLY OPERATION

When operating with only a slab sensor, the ON time for the Heat relay is calculated to satisfy the requirements of the slab sensor. The thermostat operates to maintain the slab at the minimum slab temperature setting.

NOTE: Operating with only a slab sensor can lead to either overheating or underheating of the space.

AIR AND SLAB SENSOR OPERATION

When operating with both air and slab sensors, the thermostat calculates an ON time for the Heat relay to satisfy the slab sensor's requirements and an ON time to satisfy the air sensor's requirements. The Heat relay operates for the longer of these two ON times.

During light heating loads, overheating can occur due to the minimum slab temperature requirements.

During heavy heating loads, the maximum slab temperature setting limits the ON time of the Heat relay. In this situation, underheating can occur.

MODE

Heat In the heat mode, the Heat relay is operated to satisfy the temperature requirement of the zone.

Off In the OFF mode, the Heat relay is not operated.

NOTE: If an air or slab sensor is active in the OFF mode, a freeze protection is enabled that allows the Heat relay to be operated to keep the zone above 35°F (2°C).

GETTING READY

Check the contents of this package. If any of the contents are missing or damaged, please contact your wholesaler or tekmar sales representative for assistance.

Type 508 Includes: • One Thermostat 508 • Data Brochure D 508 • User Brochure U 508

Type 509 Includes: • One Thermostat 508 • One 079 Slab Sensor • Data Brochure D 508
User Brochure U 508

SLAB SENSOR 079

The tekmar Slab Sensor 079 has a stainless steel sleeve which is designed for use in concrete, thin-set or grout. The 079 is supplied with 10' (3 m) of 2 conductor zipcord.

Installation - Slab Sensor 079

STEP ONE — INSTALLING THE SENSOR

New Installations

Thin-Set or Thin-Pour Applications

If the floor covering is to be installed over either a thin-set or thin-pour material of sufficient depth, the 079 slab sensor can be placed directly into either the thin-set material or the thin-pour material and covered over. Ensure that the sensor is located in such a position that the attached wire is able to reach to a suitable junction location. Splices within the thin-set or thin-pour should be avoided to ensure trouble free operation. The sensor should be located mid way between the heating elements to ensure a proper temperature reading.

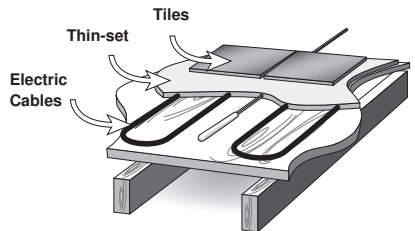

Thin Floor Coverings (less than 3/8" (10 mm))

If a thin floor covering is to be installed directly to the subfloor, a groove 1/8" (4 mm) wide by 1/16" (2 mm) deep can be cut into the surface of the subfloor to accommodate the wire for the sensor. Ensure that the sensor is located in such a position that the attached wire is able to reach to a suitable junction location. Splices under the floor covering should be avoided to ensure trouble free operation. A groove 3/16" (5 mm) wide by 3/16" (5 mm) deep by 1-3/4" (45 mm) long should be cut to accommodate the sensor. The sensor should be located mid way between the heating elements to ensure a proper temperature reading.

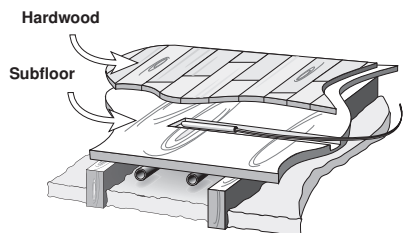

Thick Floor Coverings (greater than 3/8" (10 mm))

If a thick floor covering is to be installed directly to the subfloor, a groove 1/8" (4 mm) wide by 1/16" (2 mm) deep can be cut into the back of the flooring material to accommodate the wire for the sensor. Ensure that the sensor is located in such a position that the attached wire is able to reach to a suitable junction location.

Splices under the floor covering should be avoided to ensure trouble free operation. A groove 3/16" (5 mm) wide by 3/16" (5 mm) deep by 1-3/4" (45 mm) long should be cut to accommodate the sensor. The sensor should be located mid way between the heating elements to ensure a proper temperature reading.

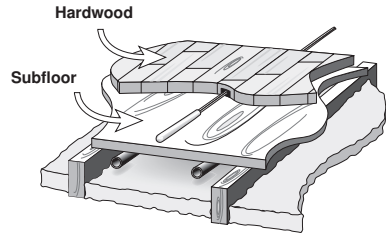

NOTE: If it is not practical to cut a groove in the surface covering, follow the installation method used for thin floor coverings.

Retrofit Installations

Tile Floor Coverings

If a Slab Sensor 079 is to be installed into an existing tile floor with sufficiently large grout lines, the sensor and wire can be installed in one of the grout lines between the tiles. Select a low traffic area of the floor that is mid way between the heating elements for the sensor location. Ensure that the sensor is located in such a position that the attached wire is able to reach to a suitable junction location. Splices within the grout should be avoided to ensure trouble free operation. Remove the appropriate grout line and place the sensor and wire in the floor. Re-grout the area.

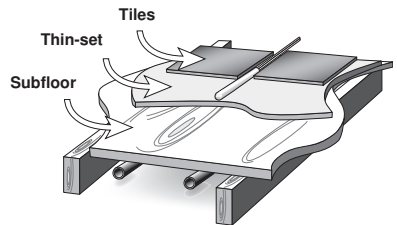

Installing the Sensor to the Bottom of a Subfloor

If the sensor is to be installed to the bottom of a subfloor, cut a piece of 1" (25 mm) thick rigid insulation into a 6" (150 mm) by 6" (150 mm) square. A groove 3/16" (5 mm) wide by 3/16" (5 mm) deep by 1-3/4" (45 mm) long should be cut into the insulation to accommodate the sensor. Place the sensor in the groove and sandwich the sensor between the insulation and the subfloor. Use a suitable fastening method to affix the insulation to the subfloor.

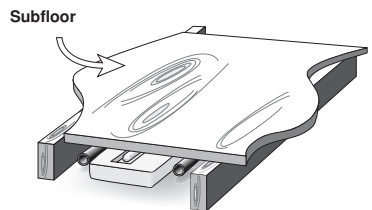

STEP TWO ————— WIRING AND TESTING THE SENSOR

Caution: Do not run sensor wires parallel to telephone or power cables. If the sensor wires are located in an area with strong sources of electromagnetic interference, shielded cable or twisted pair should be used or the wires can be run in a grounded metal conduit.

The Slab Sensor 079 is supplied with 10' (3 m) of cable. If a longer length is required, 24 AWG or larger wire can be spliced onto the two wires from the sensor. The splices should be properly soldered and protected in an accessible junction box. Follow the sensor testing instructions given in this brochure and then connect the wires to the control.

Sensor Testing Instructions

Temperature		Resistance	Temperature		Resistance	Temperature		Resistance
°F	°C	Ω	°F	°C	Ω	°F	°C	Ω
-50	-46	490,813	20	-7	46,218	90	32	7,334
-45	-43	405,710	25	-4	39,913	95	35	6,532
-40	-40	336,606	30	-1	34,558	100	38	5,828
-35	-37	280,279	35	2	29,996	105	41	5,210
-30	-34	234,196	40	4	26,099	110	43	4,665
-25	-32	196,358	45	7	22,763	115	46	4,184
-20	-29	165,180	50	10	19,900	120	49	3,760
-15	-26	139,402	55	13	17,436	125	52	3,383
-10	-23	118,018	60	16	15,311	130	54	3,050
-5	-21	100,221	65	18	13,474	135	57	2,754
0	-18	85,362	70	21	11,883	140	60	2,490
5	-15	72,918	75	24	10,501	145	63	2,255
10	-12	62,465	80	27	9,299	150	66	2,045
15	-9	53,658	85	29	8,250	155	68	1,857
						220	104	598
						225	107	553

A good quality test meter capable of measuring up to 5,000 kΩ (1 kΩ = 1000Ω) is required to measure the sensor resistance. In addition to this, the actual temperature must be measured with either a good quality digital thermometer, or if a thermometer is not available, a second sensor can be placed alongside the one to be tested and the readings compared.

First measure the temperature using the thermometer and then measure the resistance of the sensor at the control. The wires from the sensor must not be connected to the control while the test is performed. Using the chart on the following page, estimate the temperature measured by the sensor. The sensor and thermometer readings should be close. If the test meter reads a very high resistance, there may be a broken wire, a poor wiring connection or a defective sensor. If the resistance is very low, the wiring may be shorted, there may be moisture in the sensor or the sensor may be defective. To test for a defective sensor, measure the resistance directly at the sensor location.

Do not apply voltage to a sensor at any time as damage to the sensor may result.

STEP ONE — REMOVING THE FRONT COVER

Place a screwdriver or similar object into the small slot located in the top of the thermostat. Push the screwdriver against the plastic tab and pull the top of the front cover so that it pivots around the bottom edge of the base.

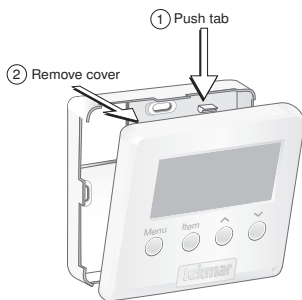

STEP TWO — MOUNTING THE BASE

The thermostat should be installed on an interior wall of the desired zone approximately 5' (1.5 m) above the floor. Do not mount the thermostat in a location that may be affected by localized heat sources or cold drafts. It may be necessary to install a draft barrier behind the thermostat to prevent air from blowing through the wiring hole and affecting the thermostat's built-in sensor.

Mount the base directly to the wall using two #6 1" screws. The screws are inserted through the mounting holes and must be securely fastened to the wall. If possible, at least one of the screws should enter a wall stud or similar surface. If the thermostat is to be mounted to a 2" x 4" electrical box, order an Adaptor Plate 007. This plate mounts to the electrical box and the thermostat mounts to the plate. Ensure that the electrical box does not provide cold air to the thermostat.

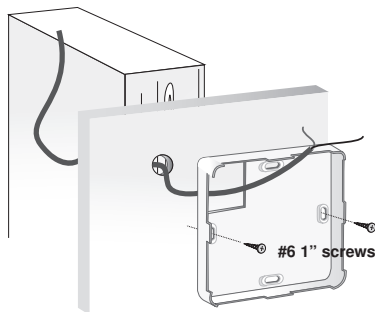

NOTE: If the 508 is to be used for remote sensing (i.e. The built-in air sensor is disabled and an indoor sensor is being used.) Mount the thermostat in the desired location in an appropriate manner.

STEP THREE — ROUGH IN WIRING

- 18 AWG or similar wire is recommended for all 24 V (ac) wiring.
- All wires are to be stripped to 1/4" (6 mm) to ensure proper connection to the control.
- Run wires from the 24 V (ac) power to the thermostat. Use a clean power source to ensure proper installation.
- Run wires from the heating device to the thermostat.

STEP FOUR — WIRING THE THERMOSTAT

(Refer to the examples on the following page.)

24 V (ac) Power

Connect the 24 V (ac) power to the *R* and *C* terminals of the thermostat. This connection provides power to the microprocessor and display of the thermostat.

Auxiliary Sensor

Either an indoor, slab, or outdoor sensor may be connected to the auxiliary sensor input. Connect the two wires from the auxiliary sensor to the Sensor terminals.

Heat Relay (*Rh – W*)

The *Heat Relay Rh – W* terminals are an isolated output. There is no power available on these terminals from the thermostat. These terminals are to be used as a switch for a 24 V (ac) circuit. This circuit can operate a low current 24 V (ac) device directly or an external relay to enable a line voltage or high current device.

STEP FIVE — INSTALLING THE FRONT COVER

Align the hinges on the bottom of the front cover with the bottom of the thermostat mounting base. Pivot the front cover around the bottom hinges and push the top against the mounting base until it snaps firmly in place.

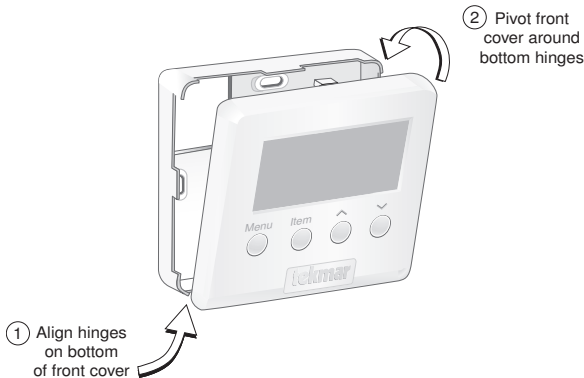

115 V (ac) —————

24 V (ac) - - - - -

Sensor Wires - - - - -

Wiring to Unpowered 24 V (ac) Relay

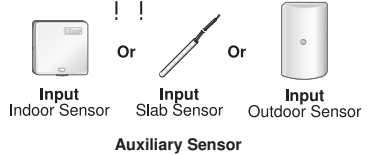
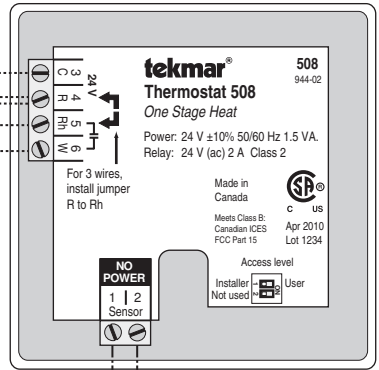
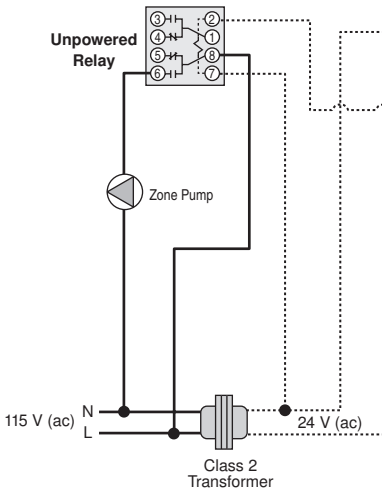

115 V (ac) —————

24 V (ac) - - - - -

Sensor Wires - - - - -

Wiring to Switching Relay

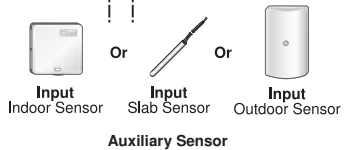
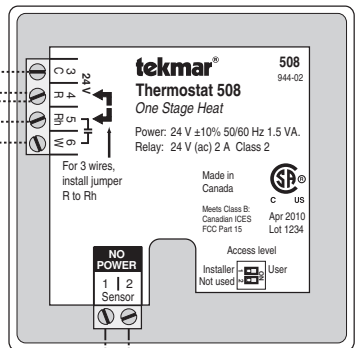
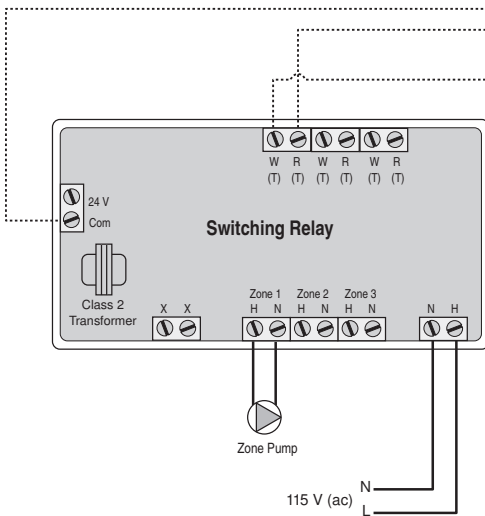

MENU BUTTON

The menu display in the Menu Field at the left of the LCD.

Three menus are available:

- View
- Adjust
- Schd (Schedule)

To select a menu, press and release the Menu button.

ITEM BUTTON

In each menu, a group of items can be selected. The abbreviated name of the selected item displays in the Item field of the LCD display.

- To view the next available item, press and release the Item button.
- To view the previous item, hold down the Item button and press and release the Up button.

ADJUSTING A SETTING

To adjust a setting:

1. Use the Menu button to select the appropriate menu.
2. Use the Item button to find the desired setting.
3. Use the Up or Down button to adjust the setting.

View Menu



ROOM TARGET

The current desired air temperature for the space. This item is only available in the Installer access level. *(Must have an active air sensor.)*



ROOM

The current air temperature for the space. *(Must have at least one active air sensor. This is the average of all active air sensors.)*



OUTDOOR

The current temperature at the outdoor sensor.
(SENS must be set to OUT.)



SLAB

The current slab temperature. *(Must have an active slab sensor.)*
The MIN segment is displayed when running at Slab Minimum.

Adjust Menu

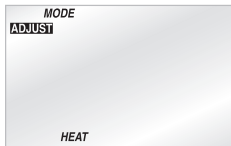

MODE

Current mode of operation of the thermostat.

OFF, HEAT



ROOM HEAT

Desired temperature for heating. *(Must have an active air sensor and be set to HEAT.)*

35 to 100°F (1.5 to 38.0°C)



SLAB MINIMUM

Minimum slab temperature. *(Must have an active slab sensor.)*

OFF, 34 to 122°F (OFF, 1.0 to 50.0°C)



SLAB MAXIMUM

Maximum slab temperature. This item is only available in the Installer access level. *(Must have an active slab sensor.)*

34 to 122°F, OFF (1.0 to 50.0°C, OFF)



SENSOR

Selects the type of auxiliary sensor present. This item is only available in the Installer access level.

OFF, Indr, SLAB, OUT



ROOM SENSOR

Selects whether the built-in sensor is functional or not. This item is only available in the Installer access level.

OFF, On



HEATING CYCLE

Determines the number of cycles per hour for the heating equipment. This item is only available in the Installer access level.

Au, 2 to 12



UNITS

The units of temperature used to display the items.

°F, °C

Schedule Menu



AWAY OVERRIDE

Selects an automatic setback temperature of 62°F (16.5°C) without altering the normal room temperature setting (Slab minimum is ignored). Select between None & Away.

Error Messages



E01

The thermostat was unable to read a piece of information stored in its memory. The thermostat was required to load the factory settings. The thermostat will stop operation until all settings are checked. To clear this error, select the Installer access level and check all of the settings in the Adjust menu.



E02

There are no active sensors selected on the thermostat. Either the internal sensor must be turned on or the auxiliary sensor must be set to either INDR or SLAB. After the fault is corrected, press any button to clear the error message.



ROOM SHORT

The thermostat's internal air sensor is short circuit. This cannot be repaired in the field. The thermostat should be replaced or returned for repair.



ROOM OPEN

The thermostat's internal air sensor is open circuit. This cannot be repaired in the field. Either turn off the internal sensor and use an auxiliary sensor set to INDR or replace the thermostat. After the fault is corrected, press any button to clear the error message.

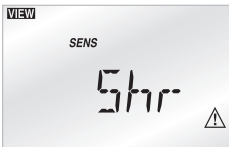

SENSOR SHORT

The auxiliary sensor is short circuit. Locate and repair the problem as described in the appropriate sensor brochure. After the fault is corrected, press any button to clear the error message.



SENSOR OPEN

The auxiliary sensor is open circuit. Locate and repair the problem as described in the appropriate sensor brochure. After the fault is corrected, press any button to clear the error message.

Technical Data

Thermostat 508 *One Stage Heat*

Literature	D508, U508, C508
Control	Microprocessor control. This is not a safety (limit) control
Packaged weight	0.5 lb. (230 g)
Dimensions	2-7/8" H x 2-7/8" W x 13/16" D (73 x 73 x 21 mm)
Enclosure	White PVC plastic, NEMA type 1
Approvals	CSA C US, meets class B: ICES & FCC Part 15
Ambient conditions	Indoor use only, -22 to 131°F (-30 to 55°C), RH ≤90% Non-condensing
Power supply	24 V (ac) ±10%, 50/60 Hz, 1.5 VA
Relay	24 V (ac) 2 A max, Class 2
Sensors	NTC thermistor, 10 kΩ @ 77°F (25°C ±0.2°C) β=3892
-Included	508 (None) 509 (079)
-Optional	tekmar type #: 070, 072, 073, 076, 077, 079, 084
Warranty	Limited 3 Year (See D508 for full warranty)

Slab Sensor 079

Literature	D079, C079
Packaged weight	0.1 lb. (50 g)
Dimensions	3/16" OD x 1-1/2" (5 OD x 38 mm)
Sensor Material	316 stainless steel, 10' (3 m) 24 AWG, 300 volt PVC insulated Zipcord
Approvals	CSA C US
Operating range	-58 to 140°F (-50 to 60°C)
Sensor	NTC thermistor, 10 kΩ @ 77°F (25°C ±0.2°C) β=3892
Warranty	Limited 3 Year (See D079 for full warranty)

Notes

Limited Warranty and Product Return Procedure

Limited Warranty *The liability of tekmar under this warranty is limited. The Purchaser, by taking receipt of any tekmar product ("Product"), acknowledges the terms of the Limited Warranty in effect at the time of such Product sale and acknowledges that it has read and understands same.*

The tekmar Limited Warranty to the Purchaser on the Products sold hereunder is a manufacturer's pass-through warranty which the Purchaser is authorized to pass through to its customers. Under the Limited Warranty, each tekmar Product is warranted against defects in workmanship and materials if the Product is installed and used in compliance with tekmar's instructions, ordinary wear and tear excepted. The pass-through warranty period is for a period of twenty-four (24) months from the production date if the Product is not installed during that period, or twelve (12) months from the documented date of installation if installed within twenty-four (24) months from the production date.

The liability of tekmar under the Limited Warranty shall be limited to, at tekmar's sole discretion: the cost of parts and labor provided by tekmar to repair defects in materials and / or workmanship of the defective product; or to the exchange of the defective product for a warranty replacement product; or to the granting of credit limited to the original cost of the defective product, and such repair, exchange or credit shall be the sole remedy available from tekmar, and, without limiting the foregoing in any way, tekmar is not responsible, in contract, tort or strict product liability, for any other losses, costs, expenses, inconveniences, or damages, whether direct, indirect, special, secondary, incidental or consequential, arising from ownership or use of the product, or from defects in workmanship or materials, including any liability for fundamental breach of contract.

The pass-through Limited Warranty applies only to those defective Products returned to tekmar during the warranty period. This Limited Warranty does not cover the cost of the parts or labor to remove or transport the defective Product, or to reinstall the repaired or replacement Product, all such costs and expenses being subject to Purchaser's agreement and warranty with its customers.

Any representations or warranties about the Products made by Purchaser to its customers which are different from or in excess of the tekmar Limited Warranty are the Purchaser's sole responsibility and obligation. Purchaser shall indemnify and hold tekmar harmless from and against any and all claims, liabilities and damages of any kind or nature which arise out of or are related to any such representations or warranties by Purchaser to its customers.

The pass-through Limited Warranty does not apply if the returned Product has been damaged by negligence by persons other than tekmar, accident, fire, Act of God, abuse or misuse; or has been damaged by modifications, alterations or attachments made subsequent to purchase which have not been authorized by tekmar; or if the Product was not installed in compliance with tekmar's instructions and / or the local codes and ordinances; or if due to defective installation of the Product; or if the Product was not used in compliance with tekmar's instructions.

THIS WARRANTY IS IN LIEU OF ALL OTHER WARRANTIES, EXPRESS OR IMPLIED, WHICH THE GOVERNING LAW ALLOWS PARTIES TO CONTRACTUALLY EXCLUDE, INCLUDING, WITHOUT LIMITATION, IMPLIED WARRANTIES OF MERCHANTABILITY AND FITNESS FOR A PARTICULAR PURPOSE, DURABILITY OR DESCRIPTION OF THE PRODUCT, ITS NON-INFRINGEMENT OF ANY RELEVANT PATENTS OR TRADEMARKS, AND ITS COMPLIANCE WITH OR NON-VIOLATION OF ANY APPLICABLE ENVIRONMENTAL, HEALTH OR SAFETY LEGISLATION; THE TERM OF ANY OTHER WARRANTY NOT HEREBY CONTRACTUALLY EXCLUDED IS LIMITED SUCH THAT IT SHALL NOT EXTEND BEYOND TWENTY-FOUR (24) MONTHS FROM THE PRODUCTION DATE, TO THE EXTENT THAT SUCH LIMITATION IS ALLOWED BY THE GOVERNING LAW.

Product Warranty Return Procedure All Products that are believed to have defects in workmanship or materials must be returned, together with a written description of the defect, to the tekmar Representative assigned to the territory in which such Product is located. If tekmar receives an inquiry from someone other than a tekmar Representative, including an inquiry from Purchaser (if not a tekmar Representative) or Purchaser's customers, regarding a potential warranty claim, tekmar's sole obligation shall be to provide the address and other contact information regarding the appropriate Representative.



tekmar Control Systems Ltd., Canada
tekmar Control Systems, Inc., U.S.A.
Head Office: 5100 Silver Star Road
Vernon, B.C. Canada V1B 3K4
(250) 545-7749 Fax: (250) 545-0650
Web Site: www.tekmarControls.com

Product design, software and literature
are Copyright © 2012 by:
tekmar Control Systems Ltd. and tekmar
Control Systems, Inc.

