

tekmar® - Data Brochure

Room Temperature Unit (RTU) 063

D 063

05/07

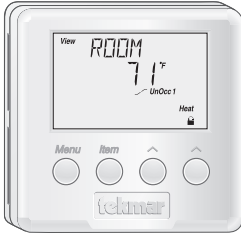

The tekmar Room Temperature Unit (RTU) 063 consists of one internal air sensor, three remote temperature sensor inputs, a liquid crystal display (LCD) and four buttons. These buttons and the LCD are used to set and view the desired room temperature. The RTU's LCD displays the current room temperature, the outdoor air temperature, temperatures at the remote air or slab sensors, and a number of other items.

The 063 can only be used with tekmar controls that are tekmar Net™ capable (tN1 or tN1 / tN2 terminals). The items that the 063 displays depends on the type of tekmar control that the RTU is connected to. To determine the exact items that are displayed by the RTU, refer to the Data Brochure for the control that the 063 is to be used with. In cases where a restricted temperature range is required, the RTU's range can be limited by changing the access level of the RTU.

Installation

STEP ONE — REMOVING THE FRONT COVER

Place a small screwdriver or similar object into the small slot located in the top of the RTU enclosure. Push the screwdriver down against the plastic tab and pull the top of the front cover so that it pivots around the bottom edge of the RTU. The back cover provides the base to which the front of the RTU mounts. Store the front of the RTU in a safe place until wiring must be completed.

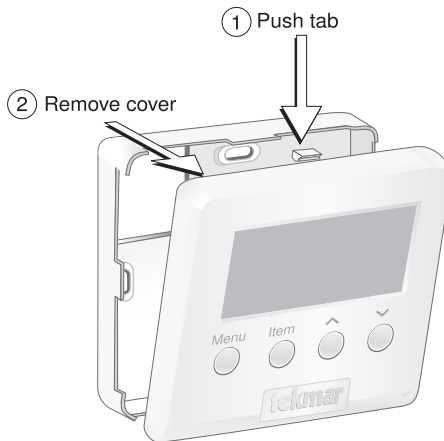

STEP TWO — MOUNTING THE RTU

The RTU should be installed on an interior wall of the desired zone to be controlled. Do not mount the RTU in a location that may be affected by localized heat sources or cold drafts. It may be necessary to install a draft barrier behind the enclosure in order to prevent air from blowing through the wiring hole and affecting the RTU reading.

Mount the RTU directly to the wall using two #6-1" screws. The screws are inserted through the mounting holes and must be securely fastened to the wall. If possible, at least one of the screws should enter a wall stud or similar surface. If local code requires that the RTU be mounted to a 2" x 4" electrical box, order an Adapter Plate 007. This plate will mount to the electrical box and the RTU will then mount to the plate. Ensure that the electrical box does not provide cold air to the RTU.

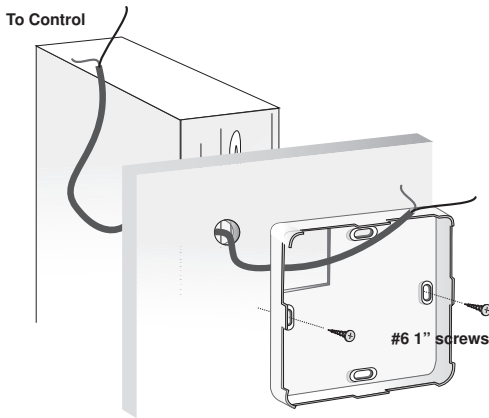

STEP THREE — WIRING THE RTU

Run 18 AWG twisted pair or similar wire between the RTU and the control. Insert the wires through the hole provided in the back of the RTU enclosure and connect them to the Com and the tekmar Net™ (tN1) terminals. Do not run the wires parallel to telephone or power lines as this may interfere with the operation of the RTU. If the RTU wires are located in an area with strong sources of electromagnetic noise, shielded cable should be used or the wires can be run in a grounded metal conduit.

NOTE: Do not apply power to the RTU. The RTU is powered by the control. The connection between the control and the RTU is polarity sensitive. The Com terminal of the RTU must be connected to the Com terminal of the control and the tekmar Net™ (tN1) terminal of the RTU must be connected to the appropriate tekmar Net™ (tN1) terminal of the control. If the wires are reversed, the display on the RTU will remain blank and the control will display a short circuit error for the tekmar Net™ (tN1) device.

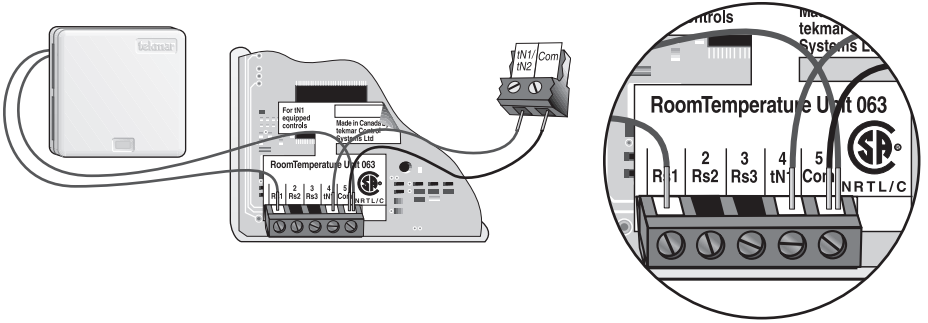

STEP FOUR ——— REMOTE SENSORS TO THE 063

Remote indoor sensors can be connected to the 063 to average the air temperature reading. Typically, multiple remote sensors are used in large open areas in a building to get an average indoor air temperature. Any type of tekmar 10k sensor can be connected to the input(s) on the 063.

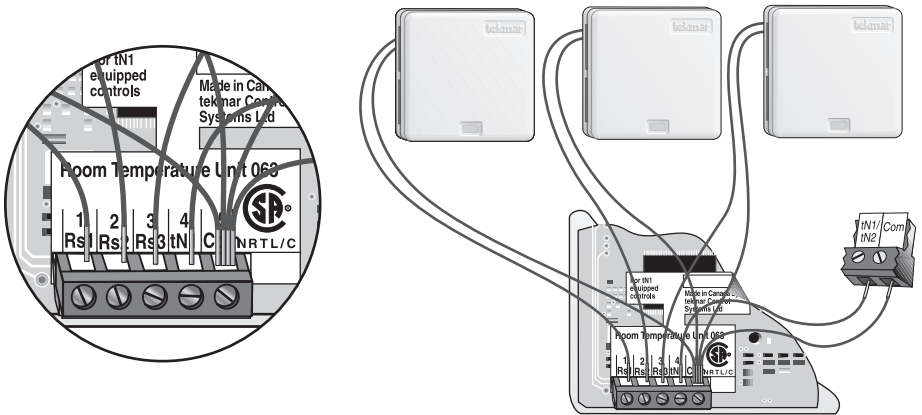

Room or Slab Temperature Control using a Slab Sensor

The RTU 063 can be configured for slab and air temperature control using a slab sensor connected to the Rs3 and Com terminals (3 & 5) and the air sensor in the RTU. The control that the 063 is connected to must be configured to support this feature. The minimum and maximum slab temperature and air temperature settings are adjusted at the RTU.

If the air temperature sensor at the RTU is turned off, the air temperature is ignored.

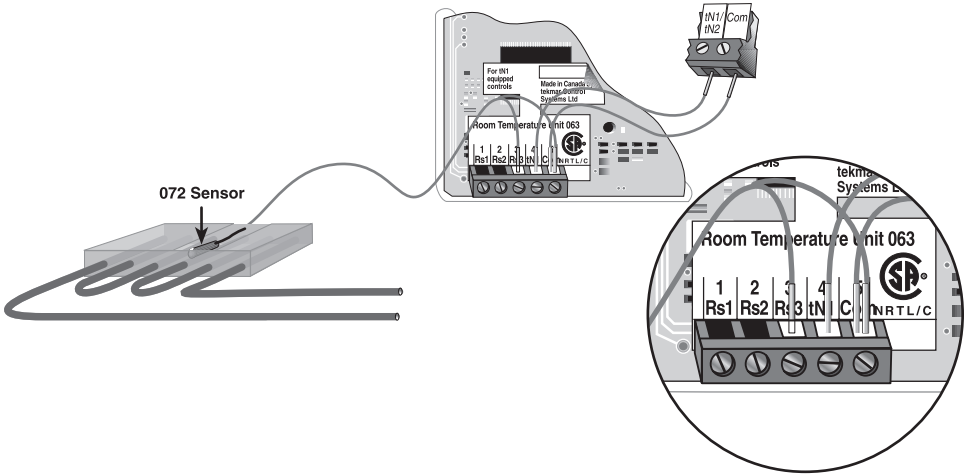

Averaging Slab Temperature

The slab sensor can only be connected to the Rs3 input on the 063. If you wish to average slab temperatures, connect slab sensors in a series / parallel arrangement as shown. The 063 will see one average slab temperature and respond accordingly.

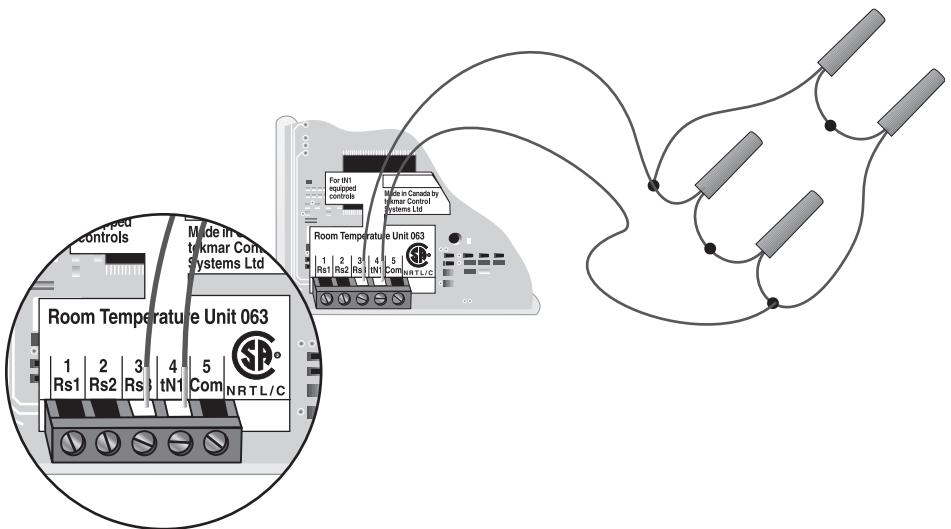

STEP FIVE ——— INSTALLING THE FRONT COVER ———

Align the hinges on the bottom of the front cover with the bottom of the RTU mounting base. Pivot the front cover around the bottom hinges and push the top against the mounting base until it snaps firmly in place.

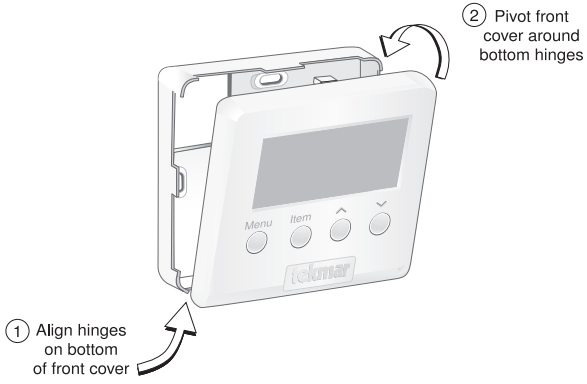

VIEW MENU

When in the view menu, press either the Up or Down button to adjust the desired room temperature. The temperature being adjusted depends on whether the control is in the Occupied or UnOccupied mode. Refer to the control's Data Brochure for available items.

ADJUST MENU

Use the Menu button to select the Adjust menu. In the Adjust menu, use the Item button to select the item to adjust, then use either the Up or Down buttons to adjust it. Refer to the control's Data Brochure for available items.

TEMPERATURE UNITS

The RTU is capable of displaying the temperature in either °F or °C. In order to select the temperature units, press the Menu button until the Miscellaneous (Misc) menu is displayed. Then, while the UNITS item is displayed, use the Up or Down button to select the desired units of measure.

ACCESS LEVELS

The RTU has four access levels that restrict the number of Menus, Items, and Adjustments that can be accessed by the user. The four access levels are Limited (LTD), User (USER), Installer (INST), and Advanced (ADV).

The access level of the RTU is found in the Miscellaneous (Misc) menu. The access level can only be viewed and / or adjusted when the Lock / Unlock DIP switch of the control that the RTU is connected to is set to the Unlock position. To determine if the RTU's access level is currently locked or unlocked, a small segment representing a padlock is viewed in the bottom right hand corner of the display.

LIMITING THE TEMPERATURE RANGE

The adjustment range of the desired room temperature can be limited in order to avoid extreme temperature settings. Set the desired room temperature in the Adjust menu. Then go to the Miscellaneous (Misc) menu and select the LTD access level. If desired, set the Lock / Unlock DIP switch on the control to the Lock position so that the access level can no longer be adjusted.

As long as the RTU remains in the LTD access level the room temperature setting(s) can only be adjusted $\pm 3^{\circ}\text{F}$ ($\pm 1^{\circ}\text{C}$) from the setting that was selected when the RTU was placed into the LTD access level.

Technical Data

ROOM TEMPERATURE UNIT (RTU) 063

| | |
|--------------------|--|
| Literature | D 063 |
| Packaged weight | 0.22 lb. (100 g), Enclosure J, white PVC plastic |
| Dimensions | 2-7/8" H x 2-7/8" W x 13/16" D (73 x 73 x 21 mm) |
| Approvals | CSA NRTL/C, meets DOC & FCC regulations for EMI/RFI |
| Ambient conditions | Indoor use only, 32 to 122°F (0 to 50°C), < 90% RH non-condensing. |
| Power Supply | tekmar control; tekmarNet™1 (tN1) |
| Internal Sensor | NTC thermistor, 10 k Ω @77°F (25°C ±0.2°C) β=3892 |
| Remote Sensors | tekmar type #: 070, 071, 072, 073, 076, 077 |

Limited Warranty and Product Return Procedure

Limited Warranty *The liability of tekmar under this warranty is limited. The Purchaser, by taking receipt of any tekmar product ("Product"), acknowledges the terms of the Limited Warranty in effect at the time of such Product sale and acknowledges that it has read and understands same.*

The tekmar Limited Warranty to the Purchaser on the Products sold hereunder is a manufacturer's pass-through warranty which the Purchaser is authorized to pass through to its customers. Under the Limited Warranty, each tekmar Product is warranted against defects in workmanship and materials if the Product is installed and used in compliance with tekmar's instructions, ordinary wear and tear excepted. The pass-through warranty period is for a period of twenty-four (24) months from the production date if the Product is not installed during that period, or twelve (12) months from the documented date of installation if installed within twenty-four (24) months from the production date.

The liability of tekmar under the Limited Warranty shall be limited to, at tekmar's sole discretion: the cost of parts and labor provided by tekmar to repair defects in materials and / or workmanship of the defective product; or to the exchange of the defective product for a warranty replacement product; or to the granting of credit limited to the original cost of the defective product, and such repair, exchange or credit shall be the sole remedy available from tekmar, and, without limiting the foregoing in any way, tekmar is not responsible, in contract, tort or strict product liability, for any other losses, costs, expenses, inconveniences, or damages, whether direct, indirect, special, secondary, incidental or consequential, arising from ownership or use of the product, or from defects in workmanship or materials, including any liability for fundamental breach of contract.

The pass-through Limited Warranty applies only to those defective Products returned to tekmar during the warranty period. This Limited Warranty does not cover the cost of the parts or labor to remove or transport the defective Product, or to reinstall the repaired or replacement Product, all such costs and expenses being subject to Purchaser's agreement and warranty with its customers.

Any representations or warranties about the Products made by Purchaser to its customers which are different from or in excess of the tekmar Limited Warranty are the Purchaser's sole responsibility and obligation. Purchaser shall indemnify and hold tekmar harmless from and against any and all claims, liabilities and damages of any kind or nature which arise out of or are related to any such representations or warranties by Purchaser to its customers.

The pass-through Limited Warranty does not apply if the returned Product has been damaged by negligence by persons other than tekmar, accident, fire, Act of God, abuse or misuse; or has been damaged by modifications, alterations or attachments made subsequent to purchase which have not been authorized by tekmar; or if the Product was not installed in compliance with tekmar's instructions and / or the local codes and ordinances; or if due to defective installation of the Product; or if the Product was not used in compliance with tekmar's instructions.

THIS WARRANTY IS IN LIEU OF ALL OTHER WARRANTIES, EXPRESS OR IMPLIED, WHICH THE GOVERNING LAW ALLOWS PARTIES TO CONTRACTUALLY EXCLUDE, INCLUDING, WITHOUT LIMITATION, IMPLIED WARRANTIES OF MERCHANTABILITY AND FITNESS FOR A PARTICULAR PURPOSE, DURABILITY OR DESCRIPTION OF THE PRODUCT, ITS NON-INFRINGEMENT OF ANY RELEVANT PATENTS OR TRADEMARKS, AND ITS COMPLIANCE WITH OR NON-VIOLATION OF ANY APPLICABLE ENVIRONMENTAL, HEALTH OR SAFETY LEGISLATION; THE TERM OF ANY OTHER WARRANTY NOT HEREBY CONTRACTUALLY EXCLUDED IS LIMITED SUCH THAT IT SHALL NOT EXTEND BEYOND TWENTY-FOUR (24) MONTHS FROM THE PRODUCTION DATE, TO THE EXTENT THAT SUCH LIMITATION IS ALLOWED BY THE GOVERNING LAW.

Product Warranty Return Procedure All Products that are believed to have defects in workmanship or materials must be returned, together with a written description of the defect, to the tekmar Representative assigned to the territory in which such Product is located. If tekmar receives an inquiry from someone other than a tekmar Representative, including an inquiry from Purchaser (if not a tekmar Representative) or Purchaser's customers, regarding a potential warranty claim, tekmar's sole obligation shall be to provide the address and other contact information regarding the appropriate Representative.



tekmar Control Systems Ltd., Canada
tekmar Control Systems, Inc., U.S.A.
Head Office: 5100 Silver Star Road
Vernon, B.C. Canada V1B 3K4
(250) 545-7749 Fax. (250) 545-0650
Web Site: www.tekmarcontrols.com

Product design, software and literature
are Copyright © 2007 by:
tekmar Control Systems Ltd. and tekmar
Control Systems, Inc.

