

Installation, Operation and Maintenance Manual

Deringer™ 20/20X/30/30X

Double Check Valve/Double
Check Detector Assemblies

Size: 20/30: 6" & 8"

20X/30X: 4" & 6"

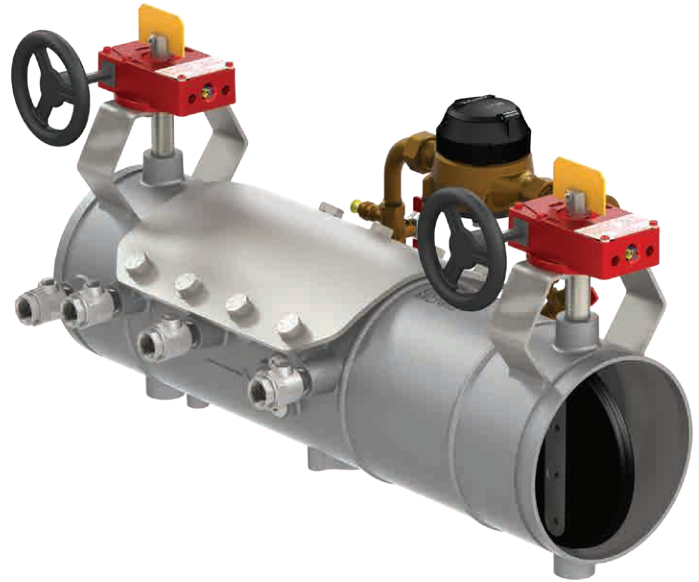

⚠ WARNING



Read this manual BEFORE using this equipment.

Failure to read and follow all safety and use information can result in death, serious personal injury, property damage, or damage to the equipment.

Keep this manual for future reference.



⚠ WARNING

You are required to consult the local building and plumbing codes prior to installation. If the information in this manual is not consistent with local building or plumbing codes, the local codes should be followed. Inquire with governing authorities for additional local requirements.

Tools Required

This list is the recommended tools for installation. Other versions of the same tool can be used. For example, allen wrenches instead of allen drive sockets.



#2 Phillips Head Screwdriver



#2 Flathead Screwdriver



Ratchet



Adjustable Wrench



Deringer Test Cock Wrench



Slip-joint Pliers



15/16" Socket
1 1/8" Socket



Wood Block 2" x 4" x 5"
Wood Block 1" x 2" x 16"

Closing Shutoff Valves Prior to Maintenance

NOTICE

When yellow/orange position indicator flags are parallel with the flow of water the shutoff valves are in the open position (B). Before doing any maintenance be sure the yellow or orange flow indicators (flags) are perpendicular to the flow of water valve body indicating shutoff valves are in the closed position (A).

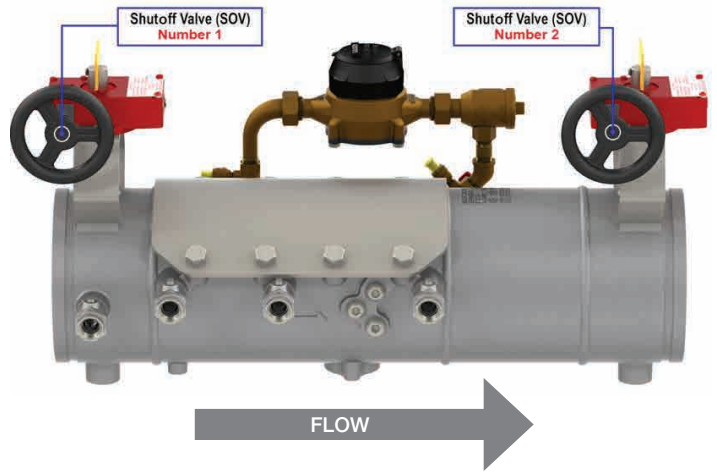
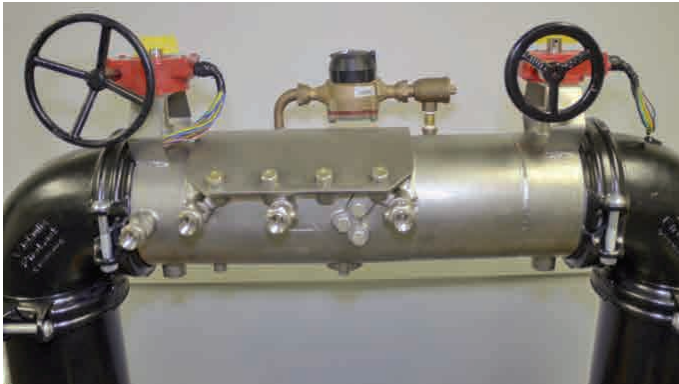

1. Slowly rotate shutoff valve #2 handle clockwise to the closed position. Flag perpendicular to flow (A).
2. Slowly rotate shutoff valve #1 handle clockwise to the closed position. Flag perpendicular to flow (A).

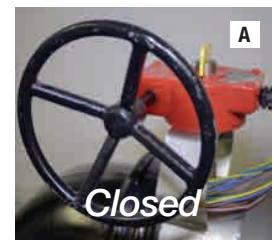
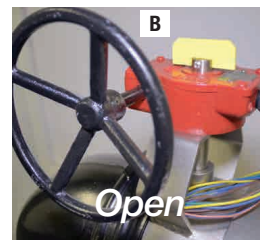

Opening Test Cocks and Bleeding All Pressure from the Line Before Maintenance

NOTE: valve is still under pressure. When opening test cocks, water will be released. Take precautions to ensure discharging water does not damage the surrounding area/equipment or create an unsafe condition.

1. **DO NOT OPEN** main test cock number 1, as it is still subject to line pressure.
2. Using the Deringer test cock wrench or a small adjustable wrench open (A) main test cock number 4. (Test cock is open when wrench flats are parallel to water flow through test cock)
3. Deringer 30/30X only: Using a #2 flathead screwdriver open bypass test cock number 2. (Test cock is open when screwdriver slot is parallel to water flow through test cock (B))
4. Using the Deringer test cock wrench or a small adjustable wrench open main test cock number 3.
5. Deringer 30/30X only: Using a #2 flathead screwdriver open bypass test cock number 1.
6. Using the Deringer test cock wrench or a small adjustable wrench open main test cock number 2.

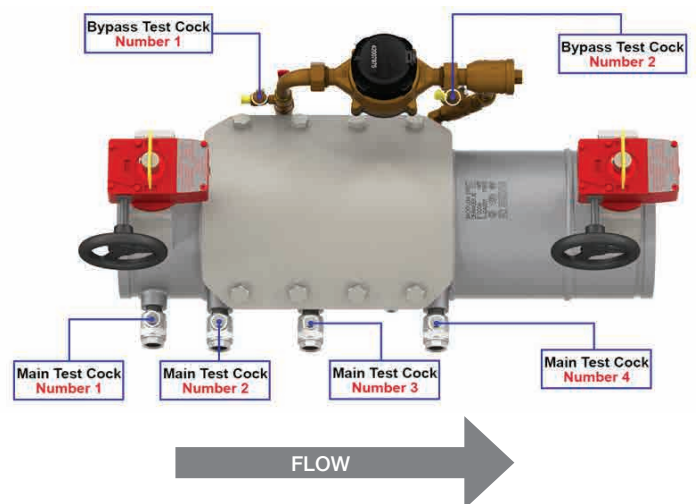

Main Test Cock

Bypass Test Cock

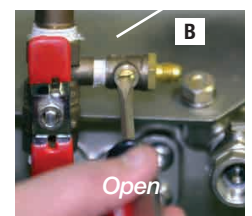
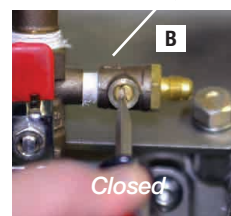
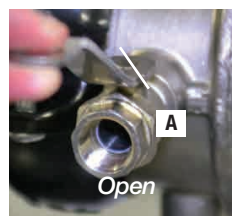
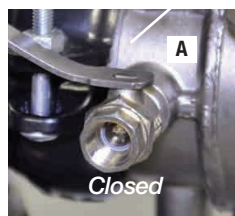

Removing Access Port Cover Plate

1. Using a $\frac{15}{16}$ " socket wrench loosen all eight bolts on the access port cover plate (A).
2. Remove bolts and tapered washers (B) and store in a safe place. Be careful not to lose tapered washers as the access cover will not seal properly without the tapered washers.
3. Remove access port cover plate (C). Do not remove access port O-ring (D).

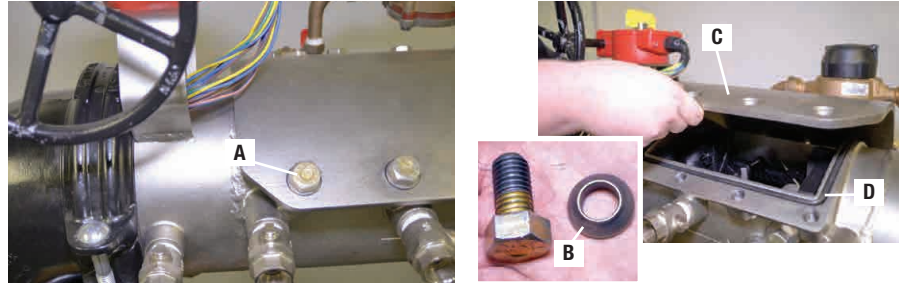

Removing the First Dual-action™ Check Module

1. Use a $\frac{15}{16}$ " socket wrench to loosen the check retainer bolts on both sides of the valve body (A). Do not completely remove check retainer bolts from valve body. Loosen the bolts until the ends of the bolts are flush with the inner wall of the valve body (B).
2. Insert a flathead screwdriver between the inner valve body and the first check module flange (C), gently push the first check module in the downstream direction until the first check module can easily be removed from the access port by hand.

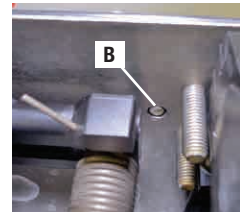
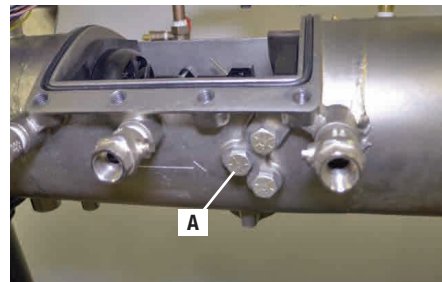

Removing the Second Dual-action Check Module

1. Use a $1\frac{1}{8}$ " socket wrench to loosen the check retainer bolts on each side of the valve body (A). Do not completely remove check retainer bolts from valve body. Loosen the bolts until the ends of the bolts are flush with the inner wall of the valve body (B).
2. Insert a flathead screwdriver between the inner valve body and the second check module flange (C), gently push the second check module in the upstream direction until the second check module can easily be removed from the access port by hand.

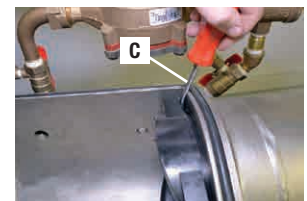
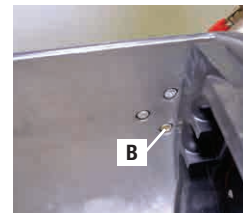
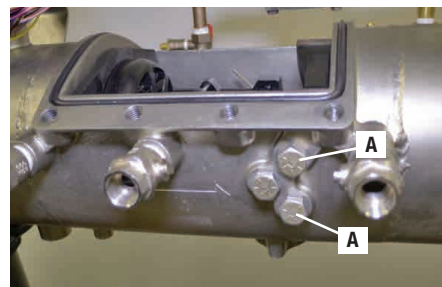

Deringer 30/30X: Disassembly and Maintenance of Bypass Check Valve

Part 1

1. Use an adjustable wrench to rotate check cover (A) counterclockwise to remove.
2. Examine cover plate O-ring (B) for damage or fouling.
3. Remove spring (C).
4. Remove check poppet assembly (D) and examine for damage or fouling.
5. Examine seat cage, located inside the bypass check valve body, for damage or fouling to the sealing seat. Do not remove unless the seat cage is being replaced.
6. Reverse the order of above instructions to reassemble bypass check valve.

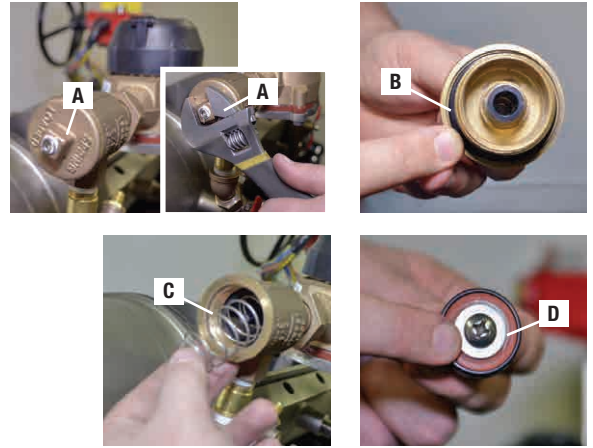

Part 2

1. To replace a damaged red silicone poppet disk, use a #2 philips head screwdriver to remove the disk retaining screw (A).
2. Remove disk retaining washer (B).
3. Use a flathead screwdriver to remove the gasket from poppet cavity (C).
4. Install new red silicone poppet disk (D).
5. Reverse the order of the above instructions to reassemble check poppet assembly.
6. Reverse the order of the instructions on the previous page to reassemble bypass check assembly.

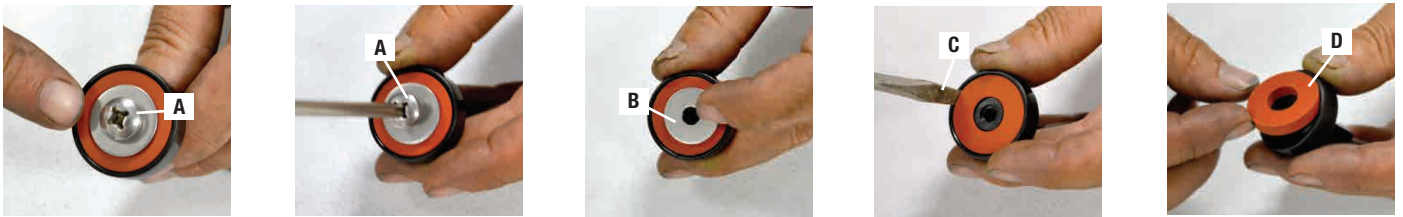

Deringer 30/30X: Removing Bypass Meter

1. Using the ball valve handles, close the #2 bypass ball valve (B) and then #1 bypass ball valve (A). (Ball valve is closed when "T" handle is perpendicular to water flow through ball valve).
2. Using a #2 flat head screw driver open bypass test cock #2 (D) and then open bypass test cock #1 (C). (Test cock is open when screw driver slot is parallel to water flow through test cock).
3. Using large adjustable pliers or a wrench, unscrew and retract bypass meter coupling nuts (E). Remove the gaskets (F) on both sides of bypass meter.
4. Gently remove bypass meter (G) from line. It is OK if the bypass fittings move slightly during the removal process.
5. Reverse order of above instructions to reinstall bypass meter. Remember to install gaskets (F) before threading meter coupling nuts into place.

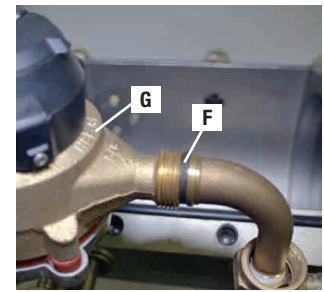
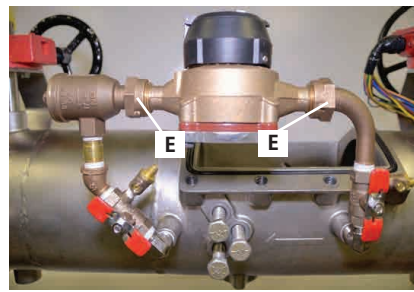
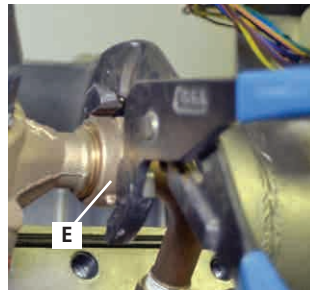
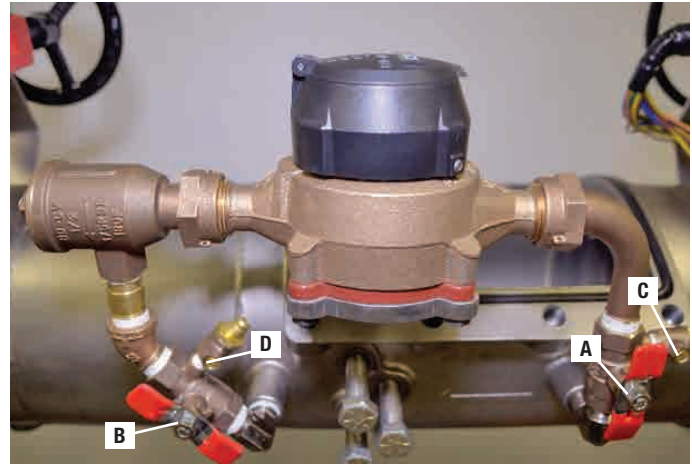

Maintenance of First Dual-action Check Module

1. Use a #2 phillips head screwdriver to remove tower screws (A) from the first check seat (B). The double torsion spring (C) is captured and does not need to be retained during maintenance.
2. After removing the tower screws (A) examine the elastomer disk (D) and check seat (E) for fouling or damage.
3. Should elastomer disk (D) need replacement unscrew disk retainer screws (F) and remove disk retainer (G). Carefully remove and replace elastomer disk (D). When replacing elastomer disk (D) be certain that no air, water or debris is trapped in the clapper (H) cavity behind the elastomer disk (D).
4. Reverse the order of the above instructions to reassemble check.
 - Elastomer disk must be flat in clapper (H) cavity before tightening disk retainer screws (F).
 - Do not cross thread disk retaining screws (F).

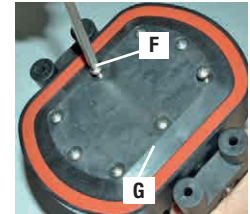
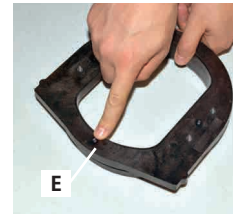
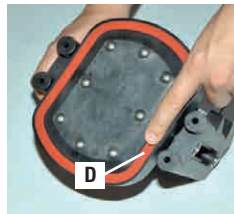
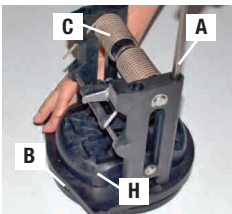

Maintenance of First Dual-action Check Module (continued)

NOTICE

The diagram on the right shows the correct orientation of the first dual-action check module when being re-attached to the seat. In order to maintain the performance of the valve pay attention to the proper orientation of the check module.

First Check Tower Bosses and Spring Arms Face Up

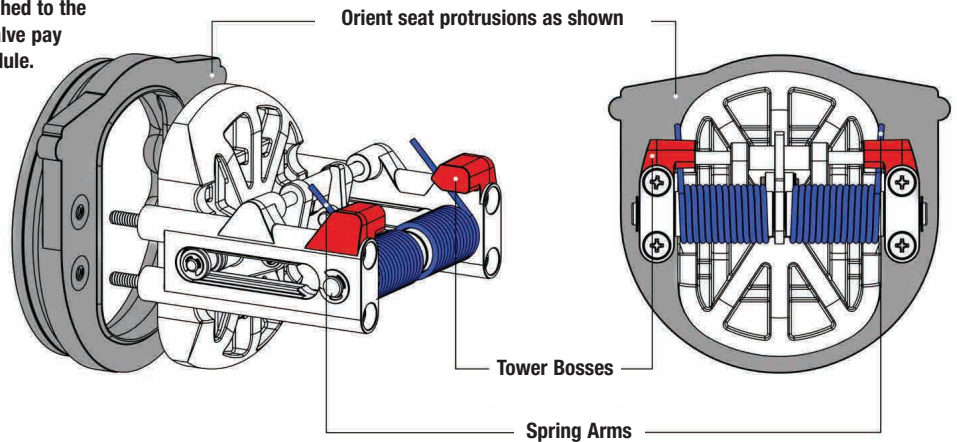

Maintenance of Second Dual-action Check Module

1. Phillips head screwdriver to remove tower screws (A) from the second check seat (B). The double torsion spring (C) is captured and does not need to be retained during maintenance.
2. After removing the tower screws (A) examine the elastomer disk (D) and check seat (E) for fouling or damage.
3. Should elastomer disk (D) need replacement unscrew disk retainer screws (F) and remove disk retainer (G). Carefully remove and replace elastomer disk (D). When replacing elastomer disk (D) be certain that no air, water or debris is trapped in the clapper (H) cavity behind the elastomer disk (D).
4. Reverse the order of the above instructions to reassemble check.
 - Elastomer disk must be flat in clapper (H) cavity before tightening disk retainer screws (F).
 - Do not cross thread disk retaining screws (F).



NOTICE

The diagram on the right shows the correct orientation of the second dual-action check module when being re-attached to the seat. In order to maintain the performance of the valve pay attention to the proper orientation of the check module.

Second Check Tower Bosses and Spring Arms Face Down

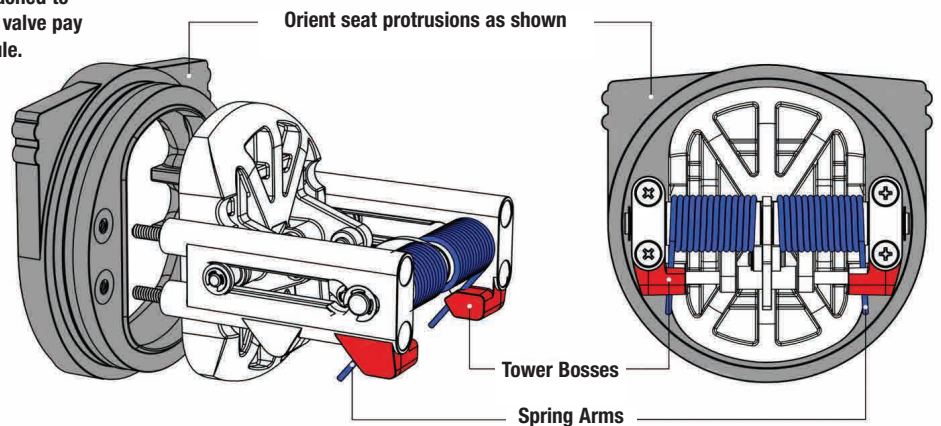

Installing Second Dual-action Check Module

1. Insert second check module (A) into access port (B) with second check towers (C) pointing downstream. Push second check module (A) downstream into valve sealing ring (D) until check O-ring (E) rests against valve sealing ring (D). Push second check module (A) into its fully seated position by hand.
2. Alternatively place 2"x4" piece of wood cut to 5" length (F) against the backside of the second check seat ring (G). Using a 1"x4" piece of wood cut to 16" length (H) as a lever between access port wall the 2"x4" (F) gently move the second check module (A) into its fully seated position.
3. Be certain second check module (A) is fully seated and check O-ring (E) is NOT "fish mouthed" or damaged.
4. Tighten the second check retaining screws (I) **ONLY AFTER** the first check module (A) has been installed.

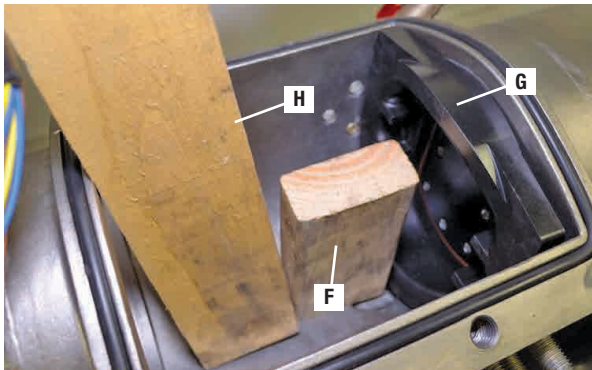
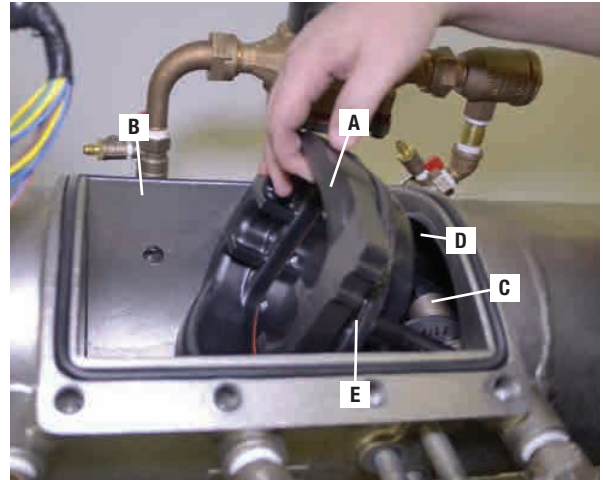

⚠ WARNING

The second check module must be fully seated to ensure retainer screws do not bind against check seat. Binding retainer screws against check seat will result in permanent damage to second check modules.



Installing First Dual-action Check Module

1. Insert first check module (A) into access port (B) with first check towers (C) pointing downstream. Push first check module (A) upstream into valve sealing ring (D) until check O-ring (E) is resting against valve sealing ring (D). Without using excessive force, push the first check module (A) into its fully seated position by hand.
2. Alternatively, using a piece of 1"x4" wood cut to 16" length (F) as a lever between the second check seat (G) and the first check towers (C), push the first check module (A) into its fully seated position.
3. Be certain first check module (A) is fully seated and check O-ring (E) is NOT "fish mouthed" or damaged.
4. Now fully tighten the first and second check retaining screws (I).

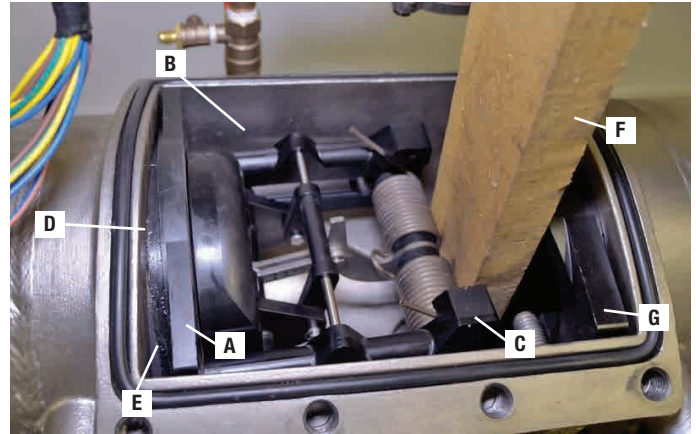

⚠ WARNING

The first check module must be fully seated to ensure retainer screws do not bind against check towers. Binding retainer screws against check towers will result in permanent damage to first check modules.

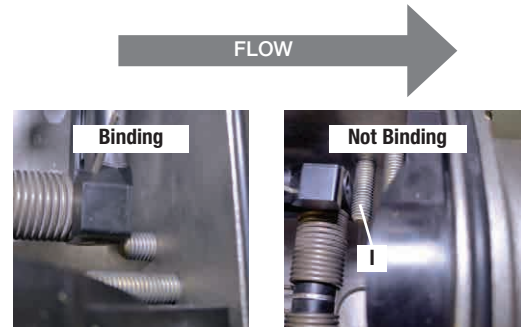

Installing Access Port Cover

1. It is best to never remove the access port O-ring (A). Should the access port O-ring (A) become dislodged, simply insert it back into access port groove (B).
2. Slide the access port cover (C) into place being certain that access port O-ring (A) does not become dislodged during the process.
3. Insert tapered washers (E), flat side facing up, and cover bolts (D) into tapered cover holes (F). tapered washers (E) must be properly installed or the access port cover (C) will not seal under pressure.
4. Use $\frac{15}{16}$ " socket wrench (G) to tighten the 4 center cover bolts (D) alternating from one side of the valve to the other. Then tighten the 4 corner bolts alternating from one side of the valve to the other.

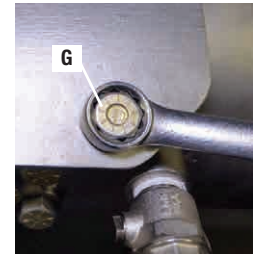
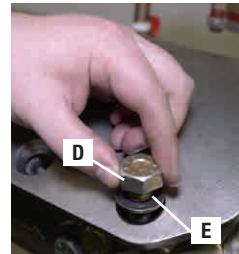
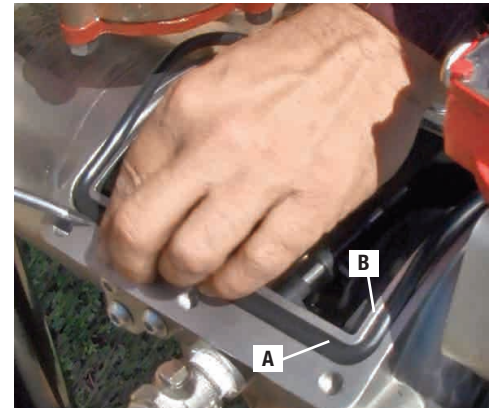
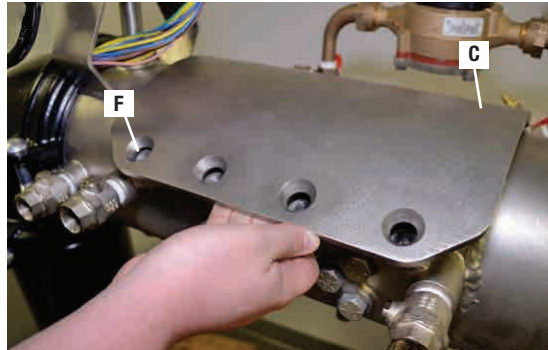

Close Test Cocks and Double Check All Closing/Sealing Mechanisms

1. Using the Deringer test cock wrench or a small adjustable wrench close main test cocks number 2, 3, and 4 (A). (Test cock is closed when wrench flats on stem are perpendicular to water flow through test cock).
2. Deringer 30/30X: Using a #2 flathead screwdriver close bypass test cock number 1 and 2 (B). (Test cock is closed when screwdriver slot on stem is perpendicular to water flow through test cock).
3. Use the "T" handles to open bypass ball valve number 1 (D) and then open bypass ball valve number 2 (C). (Ball valve is open when "T" handle is parallel to water flow through ball valve).
4. Double check to be certain of the following:
 - All cover bolts are tightened (E)
 - Deringer 30/30X: Bypass check valve cover is tightened (F)
 - Deringer 30/30X: Bypass meter coupling nuts are tightened (G)

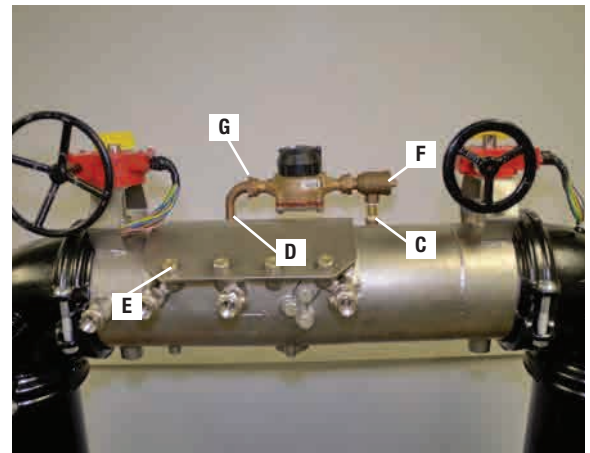
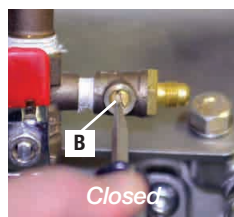
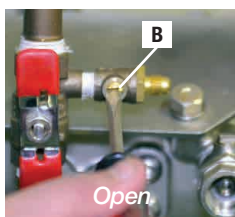
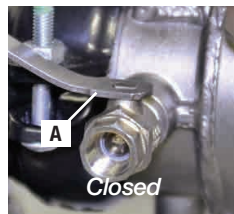
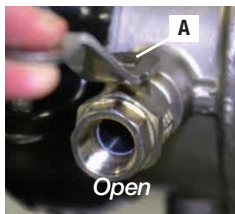
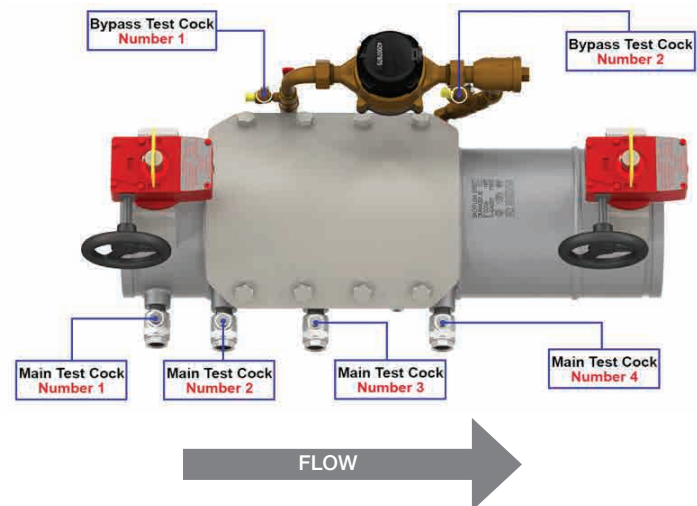

Open Shutoff Valves to Make Backflow Preventer Functional

1. Slowly rotate the number 1 shutoff valve operation handle (A) counter clockwise to the open position. (Shutoff valve is open when yellow/orange position indicator flags are parallel to the mainline water flow).
2. Slowly rotate the number 2 shutoff valve operation handle (B) counter clockwise to the open position.

NOTICE

Yellow/Orange Position Indicator Flags must be parallel to mainline water flow for Backflow Valve to be functional (C).

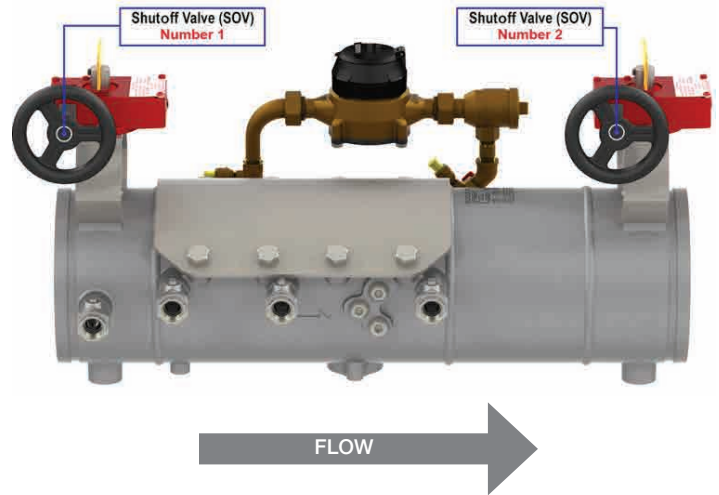
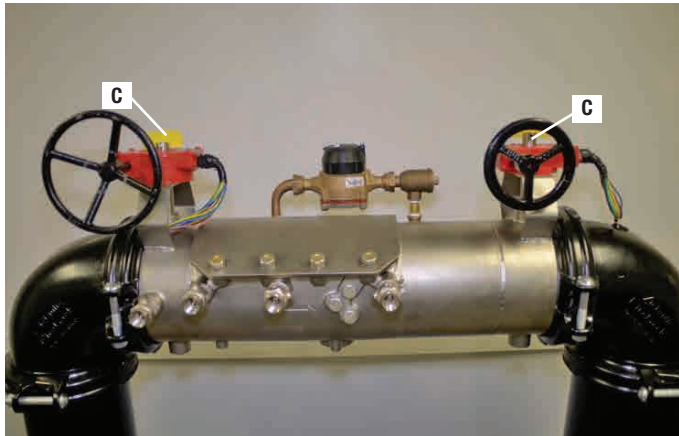
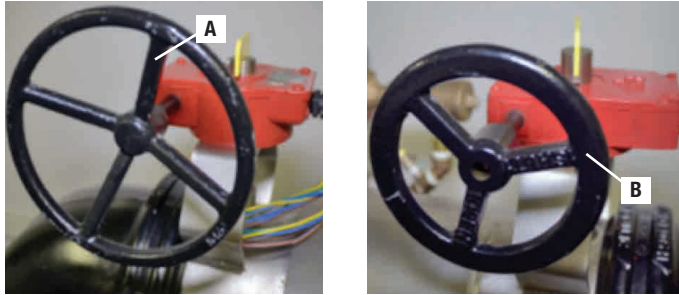

NOTICE

If a Deringer is going to be installed outdoors and the tamper switches will not be wired into the fire alarm system, the wires will need to be cut and a plug will need to be installed to protect the internal components of the gearbox.

- Step 1: Using wire cutters, cut the wires coming out of the gearbox as close to the gearbox as possible.
- Step 2: Use a piece of thread seal tape to seal the threads on a ½" NPT plug
- Step 3: Using an allen wrench, install and tighten the ½" NPT plug into the same threaded hole where the wires were previously cut.

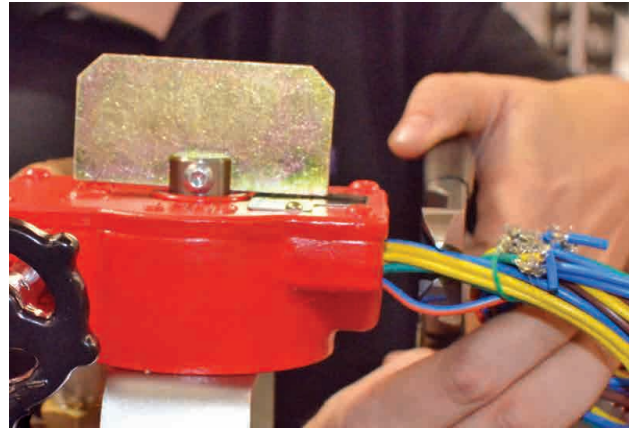

Limited Warranty: Ames Fire & Waterworks (the "Company") warrants each product to be free from defects in material and workmanship under normal usage for a period of one year from the date of original shipment. In the event of such defects within the warranty period, the Company will, at its option, replace or recondition the product without charge.

THE WARRANTY SET FORTH HEREIN IS GIVEN EXPRESSLY AND IS THE ONLY WARRANTY GIVEN BY THE COMPANY WITH RESPECT TO THE PRODUCT. THE COMPANY MAKES NO OTHER WARRANTIES, EXPRESS OR IMPLIED. THE COMPANY HEREBY SPECIFICALLY DISCLAIMS ALL OTHER WARRANTIES, EXPRESS OR IMPLIED, INCLUDING BUT NOT LIMITED TO THE IMPLIED WARRANTIES OF MERCHANTABILITY AND FITNESS FOR A PARTICULAR PURPOSE.

The remedy described in the first paragraph of this warranty shall constitute the sole and exclusive remedy for breach of warranty, and the Company shall not be responsible for any incidental, special or consequential damages, including without limitation, lost profits or the cost of repairing or replacing other property which is damaged if this product does not work properly, other costs resulting from labor charges, delays, vandalism, negligence, fouling caused by foreign material, damage from adverse water conditions, chemical, or any other circumstances over which the Company has no control. This warranty shall be invalidated by any abuse, misuse, misapplication, improper installation or improper maintenance or alteration of the product.

Some States do not allow limitations on how long an implied warranty lasts, and some States do not allow the exclusion or limitation of incidental or consequential damages. Therefore the above limitations may not apply to you. This Limited Warranty gives you specific legal rights, and you may have other rights that vary from State to State. You should consult applicable state laws to determine your rights. **SO FAR AS IS CONSISTENT WITH APPLICABLE STATE LAW, ANY IMPLIED WARRANTIES THAT MAY NOT BE DISCLAIMED, INCLUDING THE IMPLIED WARRANTIES OF MERCHANTABILITY AND FITNESS FOR A PARTICULAR PURPOSE, ARE LIMITED IN DURATION TO ONE YEAR FROM THE DATE OF ORIGINAL SHIPMENT.**



A WATTS Brand

USA: Backflow T: (978) 689-6066 • F: (978) 975-8350 • AmesFireWater.com

USA: Control Valves T: (713) 943-0688 • F: (713) 944-9445 • AmesFireWater.com

Canada: T: (888) 208-8927 • F: (888) 479-2887 • AmesFireWater.ca

Latin America: T: (55) 4122-0138 • AmesFireWater.com