

## Operation Manual

# Edge<sup>®</sup> [i] Controller For Benchmark<sup>®</sup> Boilers and Innovation Water Heaters

### Other documents for this product include:

- OMM-0143, GF-216 Innovation-Edge [i] Installation-Operation Manual
- OMM-0144, GF-217 Benchmark-Edge [i] Installation-Startup Manual
- OMM-0145, GF-218 Benchmark-Edge [i] Operation-Service Manual
- OMM-0146, GF-219 Benchmark-Edge [i] Reference Manual



### Disclaimer

The information contained in this manual is subject to change without notice from AERCO International, Inc. AERCO makes no warranty of any kind with respect to this material, including, but not limited to, implied warranties of merchantability and fitness for a particular application. AERCO International is not liable for errors appearing in this manual, not for incidental or consequential damages occurring in connection with the furnishing, performance, or use of these materials.

### Heating and Hot Water Solutions

AERCO International, Inc. • 100 Oritani Drive • Blauvelt, NY 10913  
USA: T: (845) 580-8000 • Toll Free: (800) 526-0288 • AERCO.com  
Technical Support • (800) 526-0288 • Mon-Fri, 8 am - 5 pm EST  
© 2021 AERCO

## Table of Contents

<b>SECTION 1: GENERAL INFORMATION .....</b>	<b>7</b>
1.1 INTRODUCTION.....	7
1.2 SAFETY PRECAUTIONS AND WARNINGS.....	7
1.3 POWER UP .....	8
1.4 DOWNLOAD LATEST FIRMWARE .....	8
1.5 PASSWORDS.....	8
1.5.1 Screensaver Password.....	9
1.6 MAIN MENU .....	10
1.7 EDGE CONTROLLER FRONT PANEL FUNCTIONALITY.....	10
1.8 TOUCHSCREEN BUTTON FUNCTIONALITY .....	12
1.9 SELECTIONS .....	13
1.10 ABORTING AN ACTION.....	14
1.11 TIMEOUT.....	14
<b>SECTION 2: CALIBRATION.....</b>	<b>15</b>
2.1 COMBUSTION CALIBRATION OVERVIEW .....	16
2.2 INPUT/OUTPUT.....	18
2.2.1 Temperature Sensors .....	18
2.2.2 O2 Sensor – Benchmark Only.....	19
2.2.3 Analog Inputs.....	20
2.2.4 Analog Outputs.....	21
2.3 SUBSYSTEM.....	21
2.3.1 Air Fuel Valve Calibration .....	22
2.3.2 Spark Monitor Calibration .....	23
2.4 COMBUSTION SUMMARY .....	23
2.5 COMBUSTION VALUES – INNOVATION ONLY .....	24
<b>SECTION 3: DIAGNOSTICS .....</b>	<b>25</b>
3.1 MANUAL RUN .....	26
3.2 FRONT PANEL.....	27
3.3 ANALOG OUTPUTS AND RELAYS.....	28
3.3.1 Relays.....	29
3.3.2 Analog Outputs.....	30
3.4 SUBSYSTEMS .....	30
3.4.1 Air Fuel Valve Stepper Motor .....	31
3.4.2 Blower .....	31
3.4.3 Ignition.....	32
3.5 SYSTEM.....	33
3.5.1 Pre-Start Up.....	33
3.5.2 Versions .....	34
3.6 COMM & NETWORK .....	34
3.6.1 IP Network.....	35
3.6.2 BAS – Innovation Only.....	35
3.6.3 onAER .....	36

TABLE OF CONTENTS

3.6.4 USB Storage .....	37
<b>3.7 INPUT/OUTPUT SUMMARY .....</b>	<b>37</b>
<b>SECTION 4: ADVANCED SETUP .....</b>	<b>39</b>
4.1 ACCESS .....	40
4.2 UNIT .....	40
4.2.1 Unit Settings .....	41
4.2.2 Front Panel Configuration .....	43
4.2.3 Save and Transfer Settings .....	44
4.2.3.1 Save Settings .....	46
4.2.3.2 Restore Settings .....	47
4.2.4 Fault Management .....	48
4.2.5 Freeze Protection .....	48
4.2.6 Unit Application Configuration .....	49
4.2.6.1 Unit Application Configuration - Innovation .....	49
4.2.6.2 Unit Application Configuration – Benchmark .....	50
4.2.7 Firmware Update .....	55
4.2.7.1 Preparing for Firmware Update .....	56
4.2.7.2 Download to an External Computer .....	57
4.2.7.3 Download Directly to the Controller .....	58
4.2.7.4 Updating the Controller’s Firmware .....	59
4.2.7.5 Restore Settings After Firmware Update .....	61
4.2.7.6 Troubleshooting .....	62
4.2.8 Maintenance .....	63
4.3 WHM & BST CASCADE .....	65
4.3.1 Cascade Configuration .....	65
4.3.1.1 Cascade Configuration – Innovation .....	65
4.3.1.2 Cascade Configuration – Benchmark .....	67
4.3.2 Cascade Communication .....	69
4.3.2.1 Cascade Communication – Innovation .....	69
4.3.2.2 Cascade Communication – Benchmark .....	70
4.3.3 WHM and BST Application Configuration .....	72
4.3.3.1 WHM Application Configuration – Innovation .....	72
4.3.3.2 BST Application Configuration – Benchmark .....	73
4.3.4 Operating Controls .....	74
4.3.4.1 Sequencing Controls .....	75
4.3.4.1.1 Sequencing Controls – Innovation .....	75
4.3.4.1.2 Sequencing Controls – Benchmark .....	76
4.3.4.2 Anti-Cycling Control .....	77
4.3.4.2.1 Anti-Cycling Control – Innovation .....	77
4.3.4.2.2 Anti-Cycling Control – Benchmark .....	78
4.3.4.3 Temperature Control – Benchmark Only .....	79
4.3.4.4 Valve Configuration .....	80
4.3.4.4.1 Valve Configuration – Innovation .....	80
4.3.4.4.2 Valve Configuration – Benchmark .....	81
4.3.4.5 Setpoint Range – Benchmark Only .....	82
4.3.4.6 Lead/Lag .....	83
4.4 COMM & NETWORK .....	84
4.4.1 BAS (Building Automation System) – Innovation Only .....	84
4.4.2 onAER .....	85
4.4.3 Ethernet .....	86

TABLE OF CONTENTS

4.4.4 Communication Failsafe ..... 86

4.5 ANCILLARY DEVICES.....87

4.5.1 Interlocks ..... 88

4.5.2 Relays – Benchmark Only ..... 89

4.6 PERFORMANCE ..... 89

4.6.1 Temperature Control..... 90

4.6.1.1 PID Setting ..... 90

4.6.1.2 Temperature Conformance ..... 92

4.6.1.3 Setpoint Range..... 93

4.6.1.4 FFWD Settings – Innovation Only ..... 94

4.6.2 Fire Control..... 95

4.6.2.1 Purge Control..... 95

4.6.2.2 Ignition Control ..... 96

4.6.2.3 Operating Control ..... 97

4.6.2.4 Anti-Cycling Controls ..... 98

**SECTION 5: UNIT STATUS ..... 99**

5.1 IGNITION SEQUENCE ..... 100

5.1.1 Demand ..... 101

5.1.2 Auxiliary Delay Timers ..... 101

5.1.3 Purging..... 102

5.1.4 Spark Cleaning ..... 103

5.1.5 Ignition..... 103

5.2 UNIT STATUS ..... 105

5.3 PLANT STATUS (BENCHMARK ONLY) ..... 105

5.4 BST AND WHM CASCADE STATUS..... 106

5.4.1 WHM Cascade Status – Innovation Only..... 106

5.4.2 BST Cascade Status – Benchmark BST Manager Only ..... 107

5.5 ISOLATION VALVE STATUS – BENCHMARK BST MANAGER ONLY ..... 109

5.6 RUNTIME STATISTICS ..... 110

5.7 UNIT EVENT HISTORY ..... 111

5.8 PLANT EVENT HISTORY ..... 112

5.9 IGNITION SEQUENCE STATUS ..... 112

**SECTION 6: FIELD CONTROL WIRING ..... 113**

6.1.1 Outdoor Air & Air Sensor Common Terminals ..... 113

6.1.2 Air Temp Sensor Terminal ..... 114

6.1.3 O2 Sensor Terminals (+ & -)..... 114

6.1.4 Spark Signal Terminals (+ & -)..... 115

6.1.5 Analog In Terminals (+ & -) ..... 115

6.1.6 Valve Feedback Terminals (+ & -) ..... 116

6.1.7 Shield Terminals ..... 116

6.1.8 Analog Out Terminals (+ & -) ..... 116

6.1.9 RS485 Comm Terminals (+, Ground, -) ..... 116

6.1.10 RS232 Comm Terminals (TxD & RxD) ..... 117

6.1.11 VFD/BLOWER Terminals (0-10 & AGND) ..... 117

6.1.12 Remote Interlock Terminals ..... 117

6.1.12.1 Remote Intl’k Terminals..... 117

6.1.12.2 Delayed Intl’k Terminals – Innovation Water Heaters..... 117

TABLE OF CONTENTS

---

6.1.12.3 DELAYED INTL’K Terminals – Benchmark Boilers.....118  
6.1.13 Fault Relay Terminals (N.C., COM, & N.O.) ..... 118  
6.1.14 Aux Relay Terminals (N.C., COM, & N.O.) ..... 118

**SECTION 7: EDGE [I] CONTROLLER VIEWS ..... 119**

**SECTION 8: STARTUP, STATUS, FAULT MESSAGES ..... 121**

8.1 FAULT MESSAGES.....121  
8.2 WHM AND BST CASCADE MESSAGES.....125

(This page intentionally blank)

## SECTION 1: General Information

### 1.1 Introduction

The information in this Section provides a guide to the operation of Benchmark Boilers and Innovation Water Heaters using the Edge [i] Controller. In addition, it provides information on numerous types of external sensors and control devices that can interface to the unit using terminals provided in the Water Heater's Input/Output (I/O) Box. Information regarding the set-up of all water heater Operating Modes, as well as Water Heater Management (WHM), an array of units, is also included.

**NOTE:**

Starting in Section 2, the instructions in this document are based on the assumption that you are already familiar with the Edge [i] Controller interface and can navigate through the menus and screens, enable/disable functions, make selections, edit parameters, and return to the Main Menu, etc., without detailed instructions. This section provides an introduction to navigating through the Edge Controller's screens and how use the various components in them.

### 1.2 SAFETY PRECAUTIONS AND WARNINGS

It is imperative that the initial startup of Innovation Water Heaters be performed by factory trained personnel. Operation prior to initial startup by factory trained personnel will void the equipment warranty. In addition, the following **WARNINGS** and **CAUTIONS** must be observed at all times.

**CAUTION:**

All initial installation procedures must be satisfied before attempting to start the unit.

**WARNING:**

ELECTRICAL VOLTAGES IN INNOVATION WATER HEATERS MAY INCLUDE **120 OR 220 VOLTS AC**. THEREFORE, THESE UNITS MUST BE SERVICED ONLY BY FACTORY CERTIFIED SERVICE TECHNICIANS.

**WARNING:**

DO NOT ATTEMPT TO DRY FIRE THE UNIT. STARTING THE UNIT WITHOUT A FULL WATER LEVEL CAN SERIOUSLY DAMAGE THE UNIT AND MAY RESULT IN PERSONNEL INJURY OR PROPERTY DAMAGE. THIS SITUATION WILL VOID ANY WARRANTY.

## 1.3 Power Up

Upon power-on, the splash screen appears, and the Edge Controller's **Main Menu** then appears a few seconds later. However, if the **Screensaver Password** feature (see [Section 1.5.1: Screensaver Password](#)) has been enabled, the splash screen remains, with "LOCKED" appearing at the bottom of the screen. Pressing any control causes the **Enter Password** screen to appear (see Section 1.5 below). You must enter a password to get past the splash screen.



*Figure 1.3: Splash Screen*

## 1.4 Download Latest Firmware

AERCO is committed to making the Edge Controller a reliable and easy to use front-end to your AERCO Water Heaters. As part of that effort, AERCO will be continuously monitoring user's experience and implementing improvements to the Edge Controller's firmware.

As a result, it is possible that the Edge Controller firmware on your recently delivered Water Heater may already be out of date. **You must update the firmware to the latest version before you begin using the Edge Controller for the first time.** This will eliminate potential problems and allow AERCO Technical Support to better serve you if you need assistance.

The first step is to obtain the latest firmware from AERCO. AERCO certified technicians can download latest firmware from the AERCO website, or they can contact their local AERCO rep for information on latest firmware.

Once you have either connected the Water Heater to an Ethernet cable **or** downloaded the latest firmware to a USB device, you **must** update the firmware. Instructions for both options are in [Section 4.2.7: Firmware Update](#).

## 1.5 Passwords

The Edge Controller has multiple levels of password protection.

Level	Password	Description
0	No password	The default. Some parameters are visible but "Read Only" but the user is excluded from most functionality.
1	159	Allows some basic setting changes. Appropriate for AERCO Trained technicians (ATT).

The level 2 password is reserved for AERCO Trained (ATT) and AERCO Master Technicians (AMT). It is distributed on an individual, as needed, basis.



To enter a password:

1. Go to the **Main Menu**, press **Advanced Setup**, then press **Access**. The **Enter Password** screen appears.



**Figure 1.5: Enter Password Screen**

2. Use the number keypad to enter the password (each number appears as a \*), then press **Save**. You'll have access to the functionality associated with the level of the password.

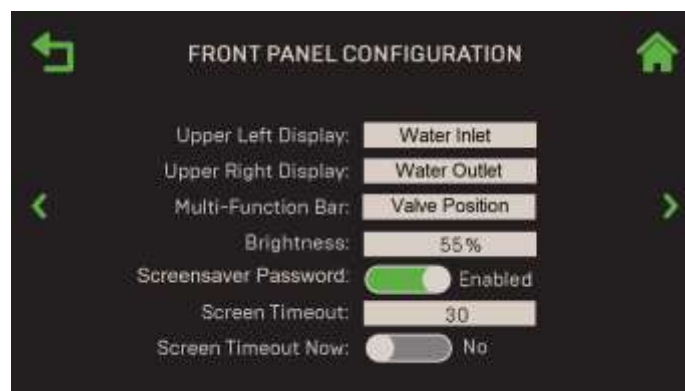
### 1.5.1 Screensaver Password

By default, all users that have not been given a password have Level 0 access to the Edge Controller, which allows them to view many parameters but they are excluded from using most functionality. However, access can be restricted to users with an Edge Controller password, effectively eliminating Level 0 access, by enabling the **Screensaver Password** parameter.

Once enabled, **all** users are presented with the **Enter Password** screen when they attempt to perform **any** function, even accessing the **Main Menu**.

To enable the **Screensaver Password** parameter, complete the instructions below. You must already have a password to perform these instructions.

1. Go to the **Main Menu** and press **Advanced Setup**. The **Advanced Setup** screen opens (see Figure 4.0).
2. Press **Access**, then enter your password and press **Save**.
3. Press **Unit**, then press **Front Panel Configuration**. The **Front Panel Configuration** screen opens.



**Figure 1-5.1: Front Panel Configuration Screen**

4. Scroll down till you see the **Screensaver Password** parameter. It displays the current state of this parameter, either **Enabled** or **Disabled**.
5. If the current state is **Disabled**, press on **Disabled**; the state changes to **Enabled**.
6. Press the **Home** button. The change is saved and a password is now required for all users.

**NOTE:**

Once the Screensaver Password is **Enabled**, after the Edge Controller times out, all users will be prompted to enter a password as soon as they touch any control.

## 1.6 Main Menu

The Main Menu give you access to all Edge [i] Controller user functionality. There are four major divisions within the menu structure.



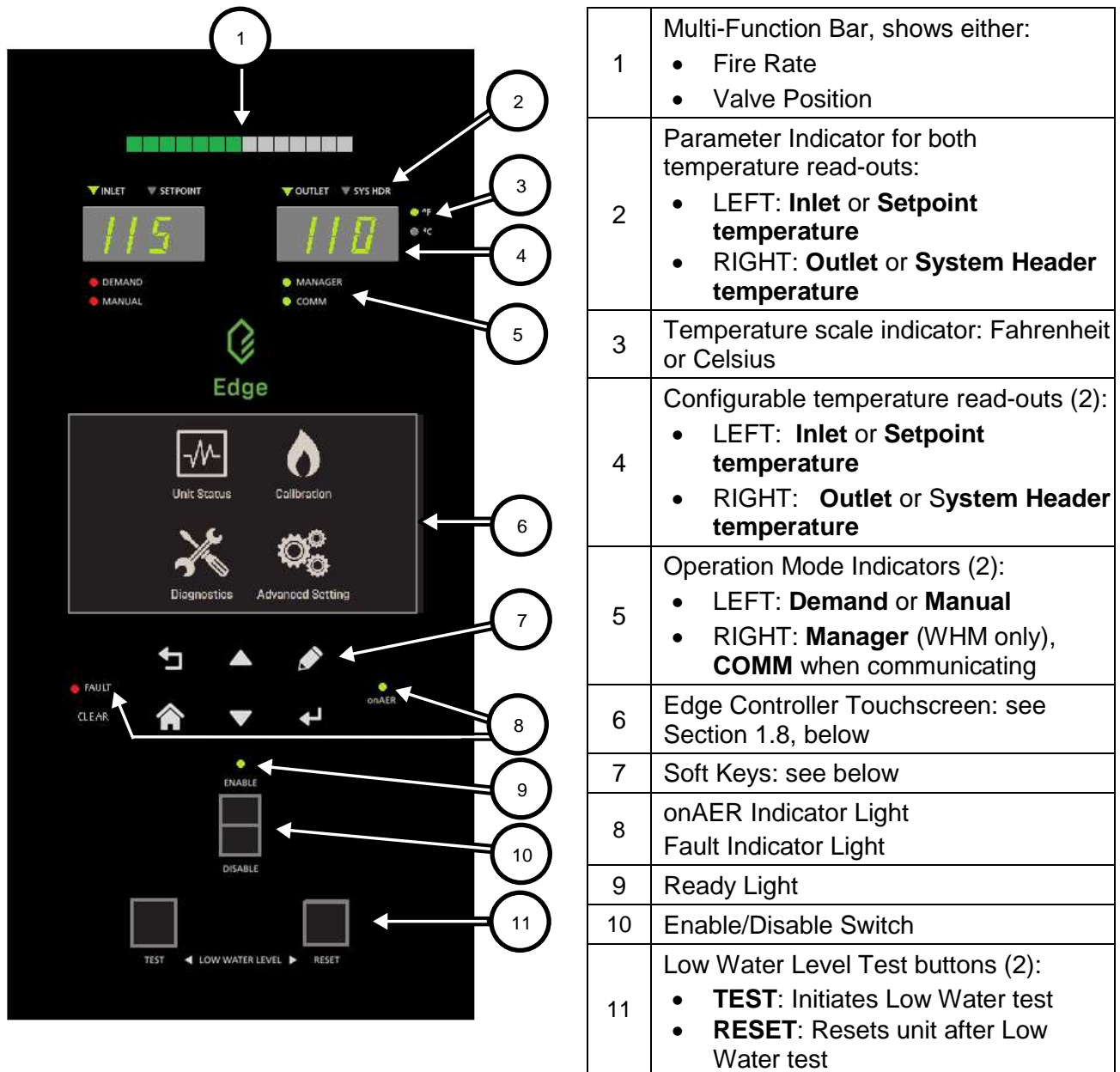
**Figure 1.6: The Edge [i] Touchscreen Main Menu**

## 1.7 Edge Controller Front Panel Functionality

The Edge Controller contains a capacitive touchscreen, which is a highly sensitive device. It continuously checks for user interaction at a very high frequency. Mechanical room environments are sometimes harsh, electromagnetically noisy and dirty, and can experience wide temperature ranges, all of which can be difficult for sensitive electronic components.

AERCO has taken precautions to ensure proper operation of your unit. We have built the Edge Controller with a high-quality glass screen for clarity and performance, with an optically bonded overlay covering the front of the enclosure to prevent dirt and liquids from affecting its operation. The Edge Controller's front panel consists of a touchscreen display along with a variety of indicators and buttons, as shown in the image below.




SECTION 1: INTRODUCTION





**Figure 1.7: Edge [i] Edge Controller Front Panel Layout**

All the completed settings and the Unit Event History are maintained throughout the power cycle.

The Soft-Keys on the Edge Controller’s front face function as follows:

TABLE 1.7: Edge Controller Front Panel Controls		
Icon	Name	Description
	Previous	Takes you to the previous screen.
	Home	Takes you to the touchscreen’s Main Menu (see Figure 1.2). If pressed during a procedure, it aborts the procedure.
	Up/Down	These buttons activate a selection box that can then be moved sequentially through the editable/selectable parameters starting from







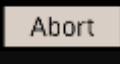
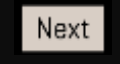
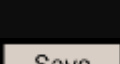


## SECTION 1: INTRODUCTION

		top left (not the title bar with home/previous icons) and moving right and then down as in reading a book.
	Edit	This button allows the editing of the parameter that is currently selected through use of up/down arrows.
	Enter	This button allows you to finalize a selection (for instance, a selected from a menu or from a pop-up (for example, password entry input completion). Note: all alphanumeric data entry is entered in the touchscreen.
<b>CLEAR</b>	Clear	Clears a fault – the red Fault light goes out.

The Edge Controller includes touchscreen reset functionality on the front panel. If the touchscreen becomes non-responsive at any time, simply press the **FAULT CLEAR** button; this will reset the touchscreen and should clear the problem.

## 1.8 Touchscreen Button Functionality

The touchscreen buttons function as follows:

TABLE 1.8: Touchscreen Controls		
Icon	Name	Description
	Previous	Takes you to the previous screen.
	Home	Takes you to the touchscreen's Main Menu (see Figure 1.6). If pressed during a procedure, it aborts the procedure.
	Left/Right	The <b>LEFT</b> arrow moves to previous point in the array or list and <b>RIGHT</b> arrow moves to next point in the array or list.
	Up/Down	The <b>UP</b> arrow increases a value, <b>DOWN</b> decreases value.
	Page Left Page Right	The arrows on left and right edges of the touchscreen scroll <b>Page Left</b> or <b>Page Right</b> in a round-robin sequence.
	Page Up Page Down	On screens with multiple pages, the <b>Page Up</b> and <b>Page Down</b> buttons moves up and down the pages.
	Abort	The <b>Abort</b> button appears when a process may need to be exited prior to completion.
	Next	Pressing <b>Next</b> takes you to the next screen in a multi-step procedure. Some procedures have a <b>Proceed</b> button instead.
	Save	1. On a pop-up screen, pressing <b>SAVE</b> saves the entered data and returns you to the previous screen. 2. On a non-pop-up screen, pressing <b>SAVE</b> saves the entered data and takes you to the next screen.
	Retry	Pressing <b>Retry</b> takes you to the previous screen and re-attempts the process step that caused the notification message to appear.
	Help	Takes you to a Help screen specific to the subject.

## 1.9 Selections

When you press on an item, it turns green and opens the screen you chose. On other screens, the screen remains until you press **Next** or **Proceed**.

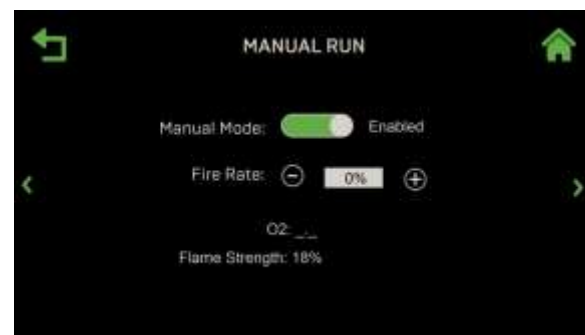


**Figure 1.9-1: Selected Item Indication – Color Change**

Some controls that have only two options have a sliding “toggle” control that indicates the current selection. In the example below on the left, **Manual Mode** is Disabled. To enable it, simply press on the control; it switches to the opposite option, the background color changes, and the label indicates the current state, as shown on the right-hand image.



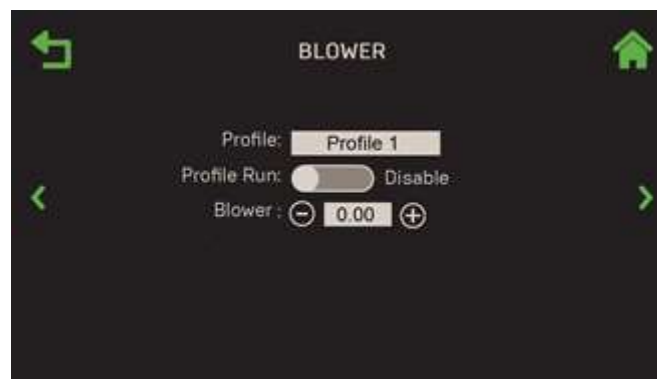
Manual Mode Disabled



Manual Mode Enabled

**Figure 1.9-2: Toggle Controls**

Some screens include a combination of “read-only” and “user-selectable” parameters. Read-Only parameters appear as plain text on a back background.



**Figure 1.9-3: List Controls**

SECTION 1: INTRODUCTION

To make a selection in a user-selectable parameter, press on the field you want to change; a list of options appears. When you select an option, the original screen reappears with your selection displayed in the field.

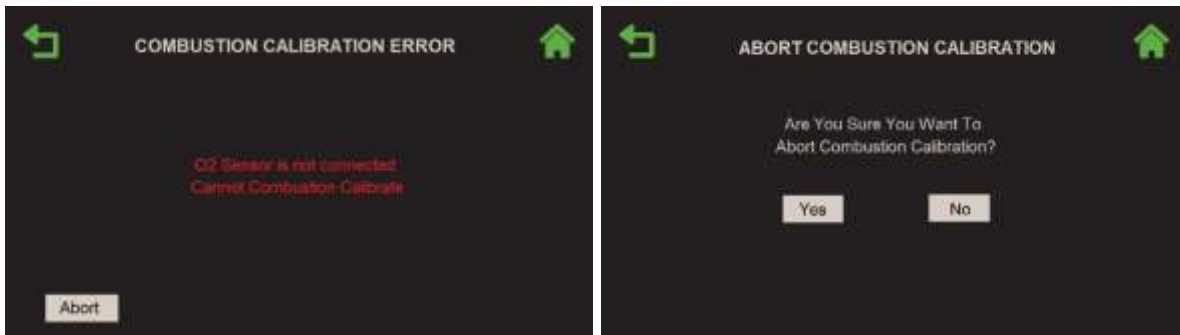


**Figure 1.9-4: List Controls**

## 1.10 Aborting an Action

On some screens, an abort action is available when a process has begun but needs to be terminated. This is initiated by pressing the **Abort** button (if it appears on the screen).

1. If a process is aborted, a confirmation screen may appear. Select **Yes** to abort the process. If no action is taken within 15 seconds, or if you select **No**, the abort is cancelled.



**Figure 1.10: Abort Confirmation Screen**

2. When an abort is successful, the process terminates and you are returned to the original screen. When an abort is performed on a screen that has multiple items, items that were entered up to that point are saved.
3. If the process completes while the Abort confirmation screen is displayed, the Abort action is nullified.

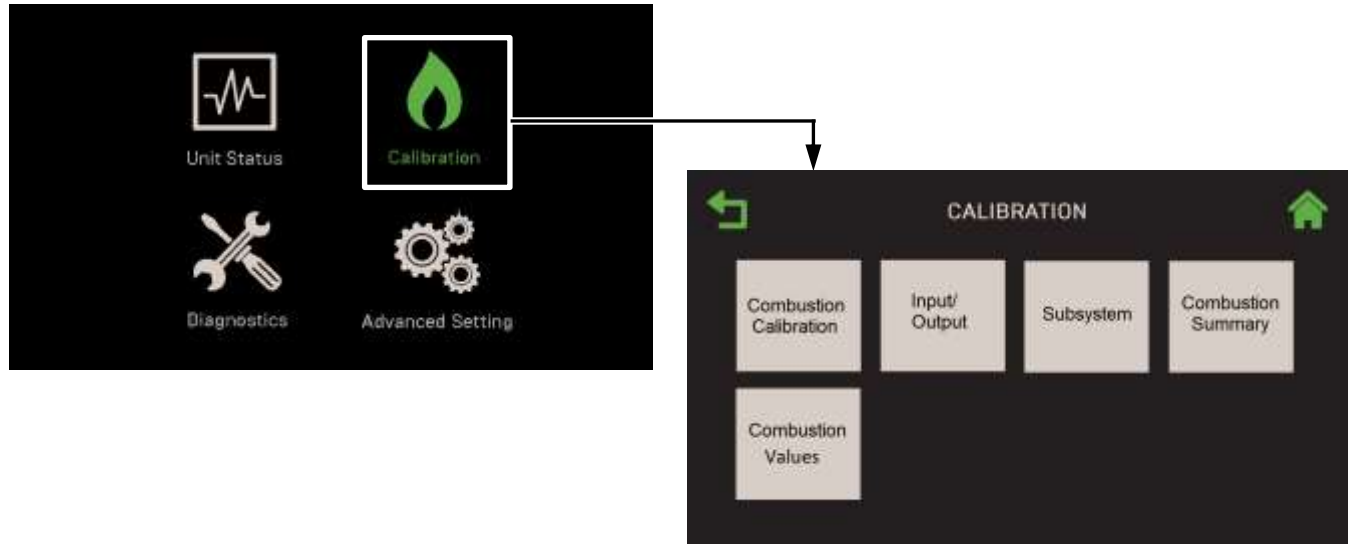
## 1.11 Timeout

There is one timeout for both screen sleep mode and password level exit. The timeout is defined as inactivity on the touchscreen and all front panel buttons.

- The default timeout period is 60 minutes.
- When a timeout occurs, the touchscreen goes into sleep mode and resets the access level to the default.
- Any activity on the control panel (including a tap on the touchscreen) will activate the touchscreen; the Enter Password screen will appear if passwords are required.

## SECTION 2: CALIBRATION

The Calibration screen provides several tools to calibrate the unit's components. It is accessed by pressing **Calibration** on the **Main Menu**.



**Figure 2.0: Calibration Screen**

This Section includes the following topics:

[2.1: Manual Combustion](#)

[2.2: Input/Output:](#)

[2.2.1: Temperature Sensors](#)

[2.2.2: O<sub>2</sub> Sensor – Benchmark Only](#)

[2.2.3: Analog Inputs](#)

[2.2.4: Analog Outputs](#)

[2.3: Subsystems](#)

[2.3.1: Air Fuel Valve](#)

[2.3.2: Spark Monitor](#)

[2.4 Combustion Summary](#)

[2.5 Combustion Values – Innovation Only](#)

### WARNING:

Before starting the instructions in this section for the first time, you must ensure that the unit has the latest Edge Controller firmware. Complete the instructions in [Section 4.2.7: Firmware Update](#) to obtain and install the latest firmware.



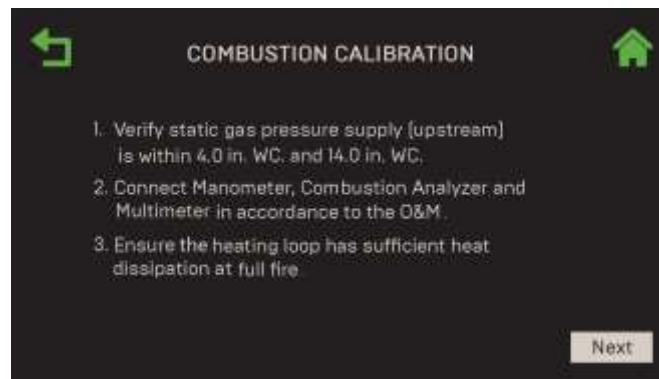
## 2.1 Combustion Calibration Overview

The Edge Controller has functionality to perform the full combustion calibration process on all Innovation Water Heaters and Benchmark Boilers.

**NOTE:**

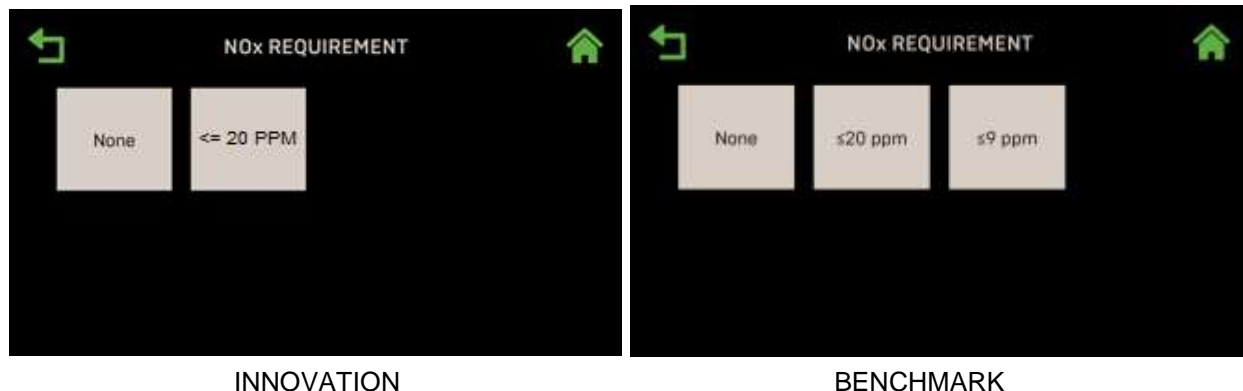
The following is a *general overview* of the combustion calibration process and the screens that appear. Combustion calibration instructions vary from model to model, and some may require specific additional steps not included below. For full combustion calibration instructions specific to your unit, consult the OMM manual that shipped with your unit.

1. Go to: **Main Menu → Calibration → Combustion Calibration**.
2. The **Combustion Calibration** screen appears listing 3 conditions that must be met or performed before continuing. Once all three conditions have been met, press **Next**.



**Figure 2.1-1: Combustion Calibration Screen**

3. On the **NO<sub>x</sub> Requirements** screen, select the NO<sub>x</sub> (Nitrogen Oxide) target to use during combustion calibration.

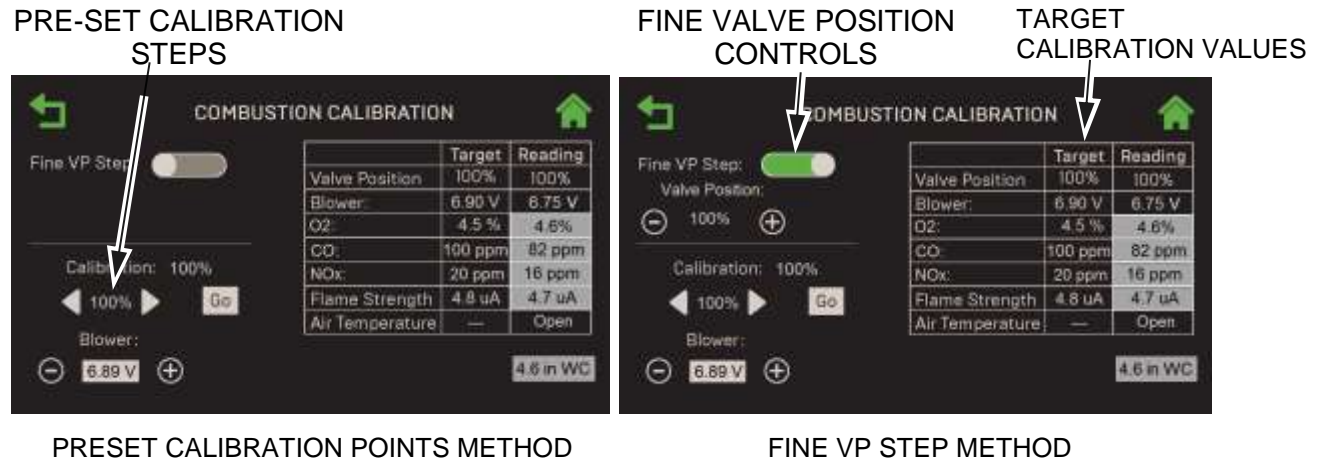


**Figure 2.1-2: NO<sub>x</sub> Requirement Screen**



SECTION 2: CALIBRATION

- The **Combustion Calibration** screen now appears. It provides two methods to ramp the unit's valve position up or down:
  - Method 1:** Toggle through the pre-set calibration points till you reach the desired valve position, then press **Go** to go to that point (left image below).
  - Method 2:** Enable **Fine VP Step**, then manually press the **+** or **-** buttons once per 1% to bring the unit to the desired valve position (right image below).



**Figure 2.1-3: Combustion Calibration Screens**

- First change the valve position to 30%, press the **Go** button, verify that the unit has ignited and is operating as expected, then use **▶** (Right) arrow key to change the valve position to **100%** and press **Go**.
- Record the downstream manometer's gas pressure reading in the **Downstream Gas Pressure** field, which appears only when **Valve Position = 100%**.
- Enter O<sub>2</sub>, NO<sub>x</sub>, CO and flame strength values from the combustion analyzer and multi-meter at the 100% fire rate in the Reading cells.
- If the O<sub>2</sub>% Reading value doesn't match the Target value, use the Blower voltage control to adjust the combustion process, then repeat this step as needed until the Reading and Target values are a close match.
- After completing the steps above at 100%, use either method (see Step 4) to reduce the valve position to the next step.
- Repeat Steps 7 – 9 until you reach the last (lowest) calibration point. At the lowest valve positions, small changes to blower voltage have a large effect.
- You can press **Back** and re-calibrate one or more points, or view the **Combustion Calibration Complete** screen by going to **Main Menu → Calibration → Combustion Summary**. See Section 2.4 for instructions on accessing this screen.

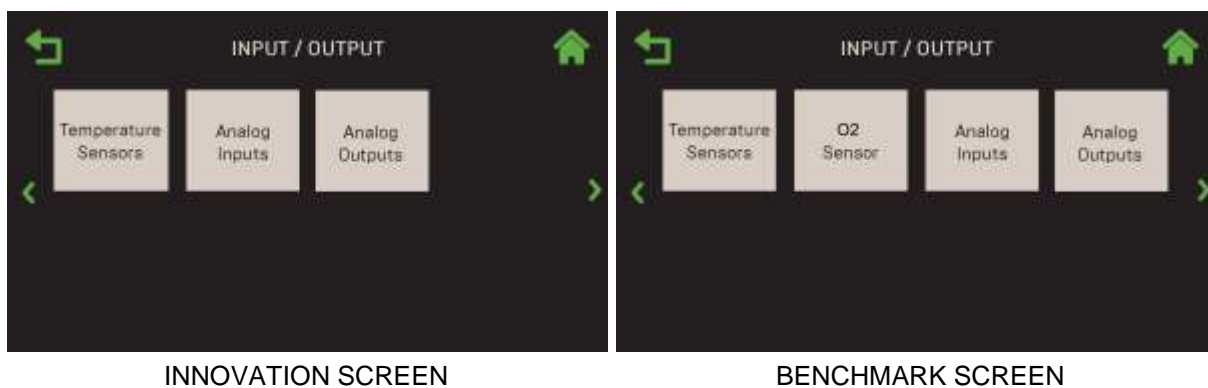
## 2.2 Input/Output

Complete the instructions below to view the current reading of the system's sensors, and either calibrate the sensor or enter offset values.

**NOTE:**

On Innovation units, this does not apply to the two Over-Temperature Limit Switches mounted on the front of the unit just under the I/O board; instructions for checking and configuring those switches are in the *Innovation Installation, Operation & Maintenance Manual* (OMM-0143, GF-216).

1. Go to: **Main Menu** → **Calibration** → **Input/Output**.
2. The Input/Output screen appears showing the sensors that are available. If a sensor is unavailable or disabled, its button is not displayed.



INNOVATION SCREEN

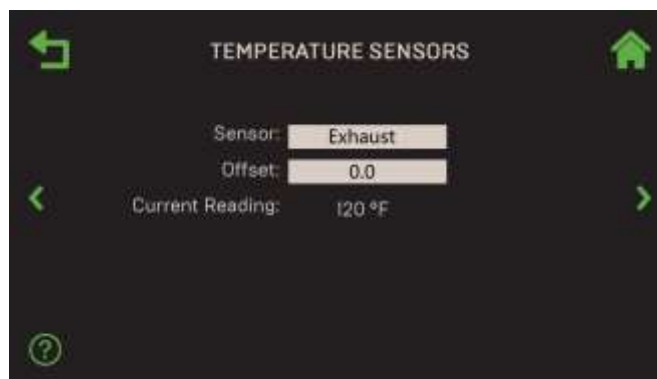
BENCHMARK SCREEN

**Figure 2.2: Calibration: Input/Output Screen**

**NOTE:** You can navigate from one **Input/Output** screen to the next in round-robin fashion using the **Page Left** and **Page Right** icons on each screen.

### 2.2.1 Temperature Sensors

This screen allows you to see the current value of all temperature sensors. If reliable feedback or external instrumentation indicates the reading is inaccurate, you can adjust its reading via the **Offset** parameter. This process can be repeated for all available analog inputs.



**Figure 2.2.1: Input/Output: Temperature Sensors Screen**

## SECTION 2: CALIBRATION

1. Go to: **Main Menu** → **Calibration** → **Input/Output** → **Temperature Sensors**.
2. Press the **Sensor** parameter and select the temperature sensor you want to view:
  - Feed Forward
  - Exhaust
  - Outside Temp
  - Air Inlet
  - Lower Inlet
  - Outlet
3. If necessary, you can adjust the **Offset** parameter to match a reliable reading or instrument by entering a value in this parameter. (Range: -10.0 to 10.0°F, default = 0.0°F)
4. Repeat Steps 2 and 3 to add offsets to other temperature sensors, as needed.

### 2.2.2 O2 Sensor – Benchmark Only

The **O2 Sensor** screen displays the current oxygen (O<sub>2</sub>) reading, and also allows you to enter an offset, and/or enable Auto Calibration of the O<sub>2</sub> sensor. This sensor is an important part of AERtrim functionality; the **O2 Sensor** screen is not visible on units that don't have an O<sub>2</sub> sensor.

**NOTE:**

This section applies only to Benchmark units.

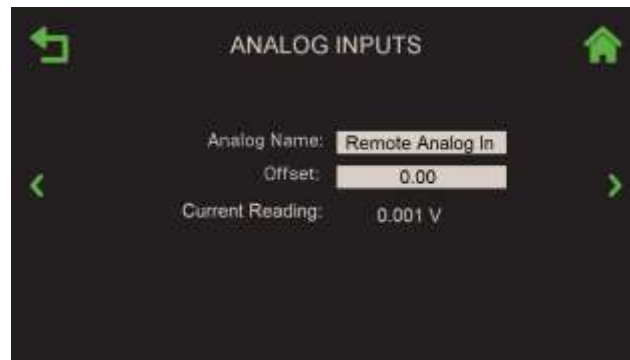


**Figure 2.2.2: O2 Sensor Screen**

1. Go to: **Main Menu** → **Calibration** → **Input/Output** → **O2 Sensor**.
2. If needed, you can enter an offset value in the **O2 Offset** field to make the reading match an external meter. The unit must be is operating with sufficient blower speed to measure O<sub>2</sub>. The current reading appears before and after entry. (Range: -3.0% to 3.0%, default = 1.0%)
3. The **Auto Calibrate Now** feature was designed for units that run continuously and therefore don't get a chance to calibrate on a defined frequency. To initiate, press **Auto Calibrate Now** and choose **Yes**. The following occurs:
  4. **Auto Calibration Status** shows the progress, including the offset implemented.
  5. When completed, **Auto Calibrate Now** reverts to **No**.
  6. You can define **Calibration Frequency** as **Daily**, **Weekly**, **Monthly** or **Never**.
  7. If you choose **Weekly**, the next calibration period will be 7 days from today. For **Monthly**, the first day of the month will be the next calibration period.
  8. If you choose **Dailey**, the **Time** (time of day) field appears; choose an appropriate time to perform the calibration.

### 2.2.3 Analog Inputs

The **Analog Inputs** screen allows you to view the current reading and calibrate two analog inputs: **Flow** and **Remote Analog In**. If reliable feedback or external instrumentation indicates the reading is inaccurate, you can adjust its reading via the **Offset** parameter. This process can be repeated for both analog inputs.



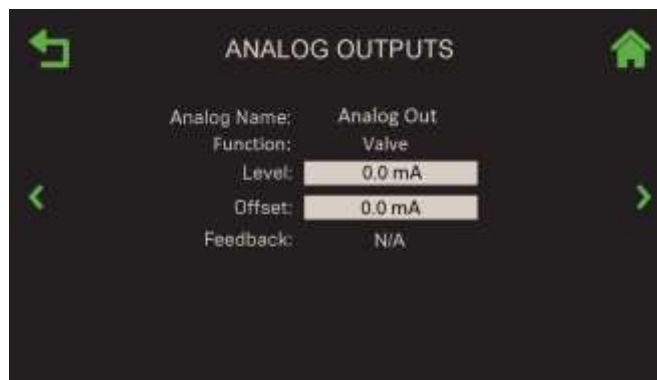
**Figure 2.3.3: Input/Output: Analog Inputs Screen**

1. Go to: **Main Menu** → **Calibration** → **Input/Output** → **Analog Inputs**.
2. Press the **Analog Name** field and choose the sensor you want to view, either **Flow** or **Remote Analog In**. The selected input is displayed and its current reading appears in the **Current Reading** field.
3. If necessary, you can adjust the **Current Reading** to match a reliable reading or instrument by entering a value in the **Offset** parameter. (Range: -1.00 to 1.00)
4. If needed, repeat Steps 2 and 3 to configure the other Analog Input.

## 2.2.4 Analog Outputs

The **Analog Outputs** screen allows you to calibrate all the available analog outputs, such as a valve or pump. If you select a programmable output, its function is displayed. You can also view feedback (if available). If reliable feedback or external instrumentation indicates the reading is inaccurate, you can adjust its reading via the **Offset** parameter. This process can be repeated for all available analog outputs.

1. Go to: **Main Menu** → **Calibration** → **Input/Output** → **Analog Outputs**.

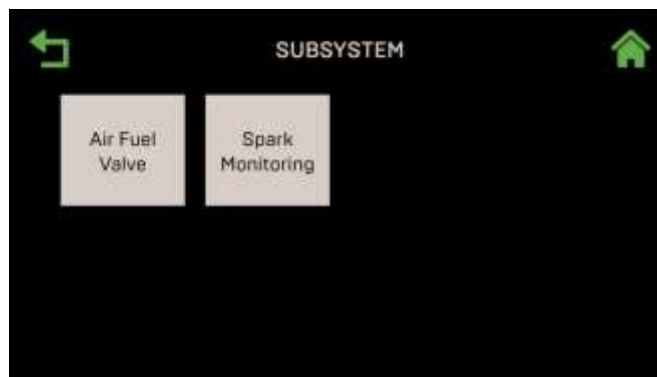


**Figure 2.2.4: Input/Output: Analog Outputs Screen**

2. The **Analog Name** field displays **Analog Out**, and the **Function** field displays the output's function.
3. In the **Level** field, choose the value (such as **10 mA**) that will drive the device connected to the Analog Out terminal and observe if the device behaves appropriately. (Range: 0.00 to 20.00 mA)
4. If necessary, you can adjust the **Level** to match a reliable reading or instrument by entering a value in the **Offset** parameter. (Range: -2.0 to +2.0 mA, default = 0.0)

## 2.3 Subsystem

The **Subsystem** screen provides access to two system components: the Air/Fuel Valve and the Spark Monitor



**Figure 2.3: Calibration: Subsystem Calibration Menu**

1. Go to: **Main Menu** → **Calibration** → **Subsystem**.
2. Press either **Air Fuel Valve** or **Spark Monitoring**.

**NOTE:** You can navigate between the Air Fuel Valve and Spark Monitor screens in round-robin fashion using the **Page Left** and **Page Right** icons on both screens.

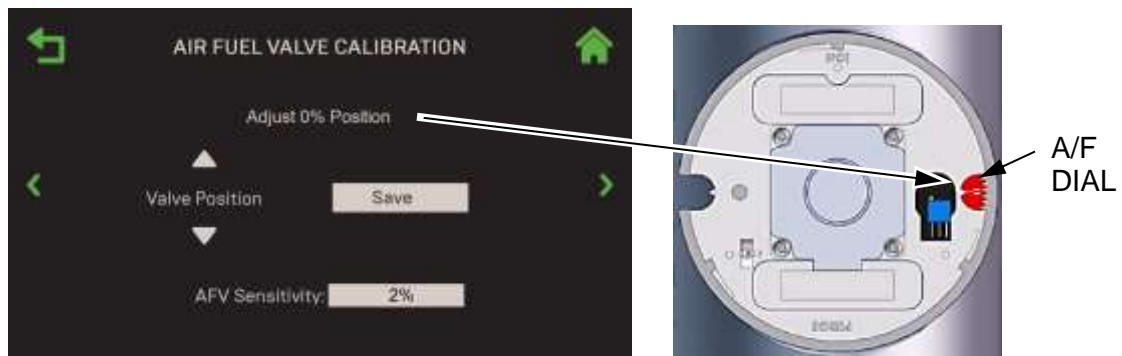
### 2.3.1 Air Fuel Valve Calibration

Complete the instructions below to calibrate the Air/Fuel Valve.



**Figure 2.3.1-1: Subsystem: Air/Fuel Valve Calibration Screen**

1. Go to: **Main Menu** → **Calibration** → **Subsystem** → **Air Fuel Valve**.
2. Before starting the calibration, you have the option of adjusting the **A/F Sensitivity**. (Range: 1% to 5%)
3. To start the calibration, press the **Start** button. The valve position (shown on the Air/Fuel dial) automatically moves to 0%. If it settled at something other than 0%, you can manually move the valve position using the **Up** or **Down** arrows until the Air/Fuel dial reaches 0%.



**Figure 2.3.1-2: Subsystem: Air/Fuel Valve Calibration Screen – After Completion**

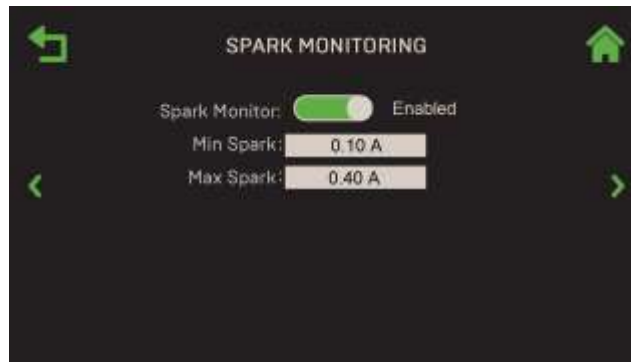
4. When the valve has settled at the 0%, the **Save** button appears. Press **Save** when done to save the 0% calibration.
5. The valve now moves to the 100% position and the same options are available. Press **Save** when done to save the 100% calibration.
6. The valve position now automatically moves to the 50% position. The **Save** button is replaced with the **Done** button to signify completion, and a status message is displayed above the valve position adjustment.

**NOTE:**

If the valve does not reach or read 50%, you can press **Done** but then repeat the process to ensure calibration.

### 2.3.2 Spark Monitor Calibration

The **Spark Monitoring** screen gives you the option of bounding the Spark Monitor's measurement range by specifying the minimum and maximum spark current.



**Figure 2.3.2: Subsystem: Spark Monitor Screen – Spark Monitor Enabled**

1. Go to: **Main Menu** → **Calibration** → **Subsystem** → **Spark Monitoring**.
2. To set a spark range, specify values in the following fields:
  - **Min Spark**: Range: 0.00 to 0.29 A
  - **Max Spark**: Range: 0.30 to 2.50 A

## 2.4 Combustion Summary

The **Combustion Calibration Complete** screen provides the results of the previous combustion calibration, along with a color-coded honeycomb indicating whether the result at each calibration point was within acceptable limits (green) or outside acceptable limits (red).



Valve Position	O2	NOx	CO	Flame Strength
16%	8.0% (red)	29 ppm (red)	170 ppm (red)	2.0 uA (red)
20%	5.5% (green)	8 ppm (green)	70 ppm (green)	6.0 uA (green)
40%	5.5% (green)	8 ppm (green)	70 ppm (green)	5.9 uA (green)
60%	8.0% (red)	29 ppm (red)	170 ppm (red)	3.7 uA (red)
80%	5.5% (green)	8 ppm (green)	70 ppm (green)	5.8 uA (green)
100%	8.0% (red)	29 ppm (red)	170 ppm (red)	6.1 uA (green)

Manifold Gas Pressure 4.4 in WC  
Completed on 06/18/2019

**Figure 2.4: Calibration: Combustion Calibration Complete Screen**

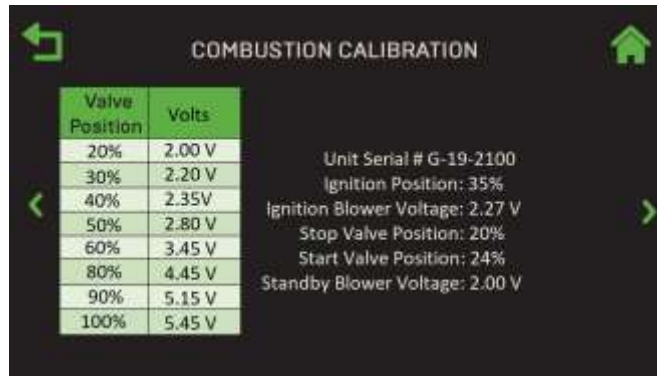
1. Go to: **Main Menu** → **Calibration** → **Combustion Summary**.



- This read-only screen remains accessible and unchanged until combustion calibration is performed again.

## 2.5 Combustion Values – Innovation Only

The **Combustion Calibration** screen, available only on Innovation water heaters, shows the expected Blower voltages for each valve position, along with some additional information, such as the unit's Start and Stop valve positions. This screen is just a reference for the specified model and does not change.



Valve Position	Volts
20%	2.00 V
30%	2.20 V
40%	2.35V
50%	2.80 V
60%	3.45 V
80%	4.45 V
90%	5.15 V
100%	5.45 V

Unit Serial # G-19-2100  
Ignition Position: 35%  
Ignition Blower Voltage: 2.27 V  
Stop Valve Position: 20%  
Start Valve Position: 24%  
Standby Blower Voltage: 2.00 V

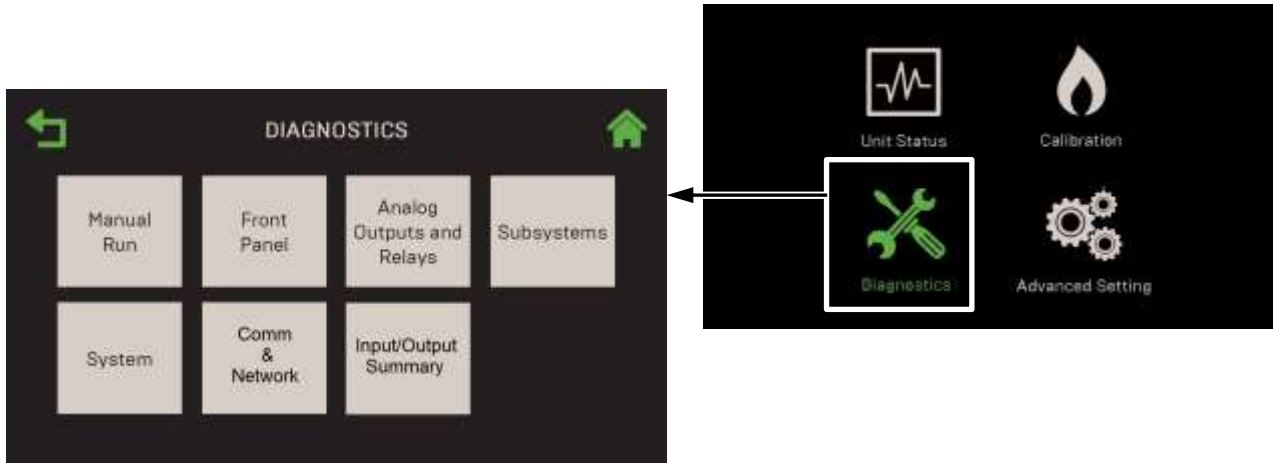
**Figure 2.5: Calibration: Combustion Calibration Screen**

- Go to: [Main Menu](#) → [Calibration](#) → [Combustion Values](#).



# SECTION 3: DIAGNOSTICS

The Diagnostics menu provides access to a number of tools you can use to diagnose a suspected or observed fault. It is accessed by pressing **Diagnostics** on the **Main Menu**



**Figure 3.0: Diagnostics Menu**

This Section includes the following topics:

<a href="#">3.1: Manual Run</a>	<a href="#">3.6: Comm &amp; Network</a>
<a href="#">3.2: Front Panel</a>	<a href="#">3.6.1: IP Network</a>
<a href="#">3.3: Analog Outputs and Relays</a>	<a href="#">3.6.2: BAS – Innovation Only</a>
<a href="#">3.3.1: Relays</a>	<a href="#">3.6.3: onAER</a>
<a href="#">3.3.2: Analog Outputs</a>	<a href="#">3.6.4: USB Storage</a>
<a href="#">3.4: Subsystems</a>	<a href="#">3.7: Input/Output Summary</a>
<a href="#">3.4.1: Air Fuel Valve Stepper Motor</a>	
<a href="#">3.4.2: Blower</a>	
<a href="#">3.4.3: Ignition</a>	
<a href="#">3.5: System</a>	
<a href="#">3.5.1: Pre-Start Up</a>	
<a href="#">3.5.2: Versions</a>	

**WARNING:**

Before starting the instructions in this section for the first time, you must ensure that the unit has the latest Edge Controller firmware. Complete the instructions in [Section 4.2.7: Firmware Update](#) to obtain and install the latest firmware.

## 3.1 Manual Run

Most diagnostic test procedure require the unit to be in **Manual Mode**. Putting the Edge Controller in **Manual Mode** does the following:

- Initially reduces the unit's Fire Rate to zero.
- Allows the system to display certain diagnostic options that are otherwise unavailable.
- Suppresses event transmissions to external systems.
- Lights the red **Manual** LED on the Edge Controller's front face.
- Flags all events in the internal log as related to Manual Mode.

To put the unit in Manual Mode:

1. Go to: **Main Menu** → **Diagnostics** → **Manual Run**.



**Figure 3.1: Diagnostics: Manual Run Screen – Manual Mode Enabled**

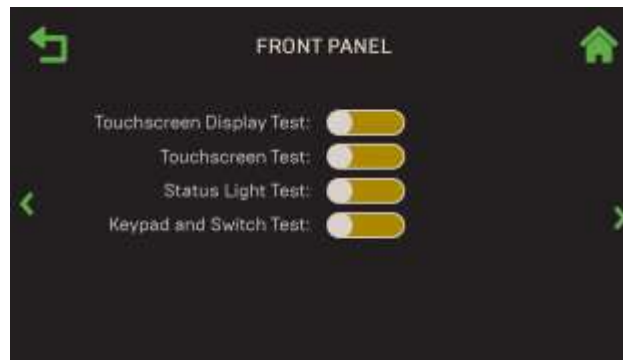
2. Enable the **Manual Mode** toggle. The red Manual LED lights on the Edge Controller's front face turns on, the unit shuts down (if not already) and stays in **Manual Mode** until it is disabled from this screen, or until the session times-out.
3. When Manual Mode is enabled, the Fire Rate control appears. You can use these controls to manually fire the unit in 1% increments using the + and – controls, or press on the field and manually enter a specific fire rate.
4. When you are done operating in **Manual Mode**, use the **Manual Mode** toggle to disable it. All initiated/active diagnostic routines/processes will terminate, the **Manual** LED on the Edge Controller's front face will go off, and the unit will resume normal operation.

## 3.2 Front Panel

The **Front Panel** screen provides access to several tests of the Edge Controller's touchscreen, LEDs, keypad and buttons.

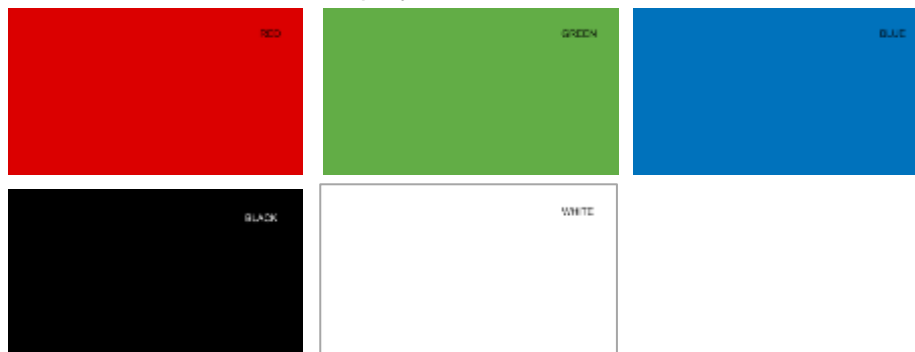
To run Front Panel diagnostics:

1. Go to: **Main Menu** → **Diagnostics** → **Front Panel**.



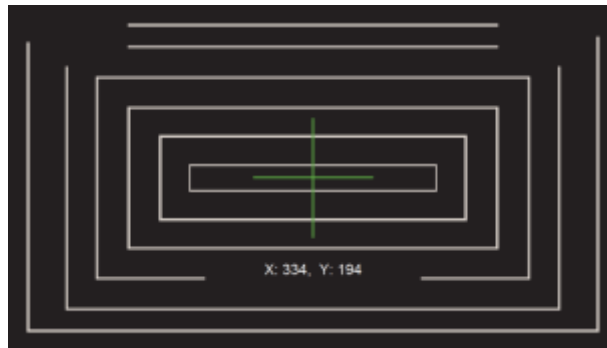
**Figure 3.2-1: Diagnostics: Front Panel Screen**

2. The **Front Panel** screen opens, with all diagnostic tests currently off.
3. To perform a test, press its toggles:
  - **Touchscreen Display Test:** Sequentially displays five colors, full-screen, for 5 seconds each. Observe each screen to determine if any pixels fail to show any color. The test ends after the 5<sup>th</sup> color is displayed.



**Figure 3.2-2: Diagnostics: Touchscreen Display Test**

- **Touchscreen Test:** Allows you to verify touch calibration. When you enable this test, move your finger all around the screen and to all four corners. Verify that X and Y coordinates change as you move your finger around the screen.



**Figure 3.2-3: Diagnostics: Touchscreen Display Test**

- **Status Light Test:** Walks through each of the LED lights Individually, 7-segment displays, 7-segment display parameter type indicators and multi-function bar before lighting them all at the same time for 5 seconds.
- **Keypad and Switch Test:** Allows you to verify the buttons on the Edge Controller's front face, below the touchscreen; this test does not include the Low Water Level Test & Reset buttons.



**Figure 3.2-4: Diagnostics: Keypad and Switch Test Screen**

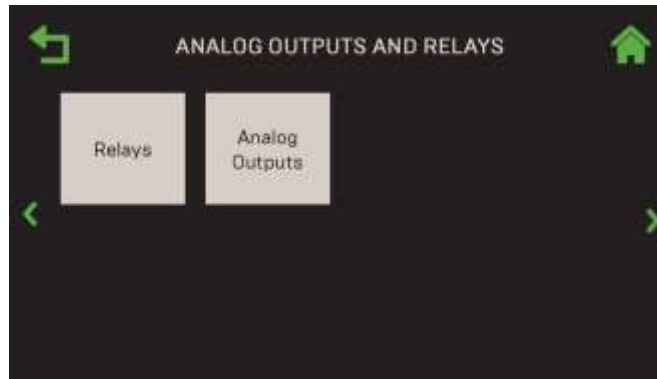
4. Upon completion of a test, the toggle reverts to its initial (off) position and you can perform one of the other tests.

### 3.3 Analog Outputs and Relays

The **Analog Outputs and Relays** screen allows you to test the units relays and analog outputs. This screen is accessible only in **Manual Mode**.

To run relays and analog output diagnostics:

1. Go to: **Main Menu → Diagnostics → Analog Outputs and Relays**.



**Figure 3.3: Diagnostics: Analog Outputs and Relays Screen**

2. Press either **Relays** or **Analog Outputs**.

**NOTE:** You can navigate between the **Analog Output** and **Relays** screens in round-robin fashion using the **Page Left** and **Page Right** icons on both screens.

### 3.3.1 Relays

The Relays screen displays a list of all relays in the system and allows you to manually test each one individually to confirm they are functioning. Complete the instructions below to test the unit's relays.

1. Go to: **Main Menu → Diagnostics → Analog Outputs and Relays → Relays**.



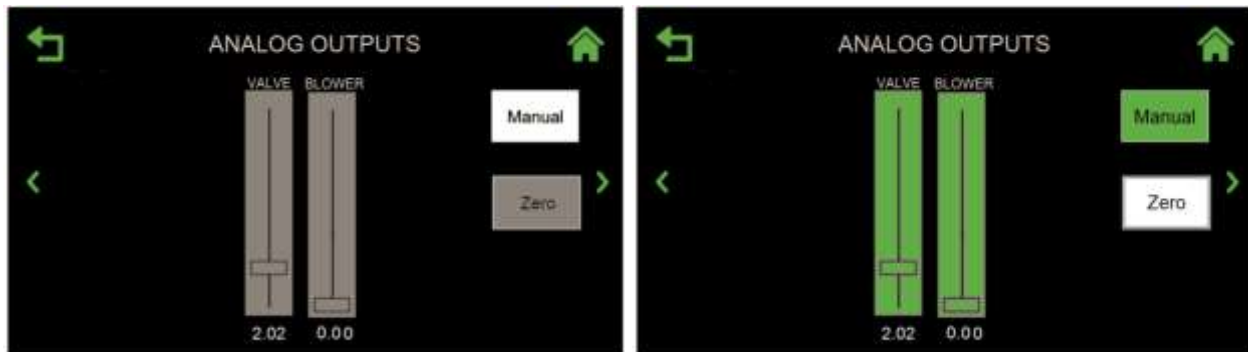
**Figure 3.3.1: Analog Outputs and Relays: Relays Screens**

2. Press the relay you want to test; it turns green (as shown above), enabling it for 1 minute, after which it is automatically disabled. You can select multiple relays to test at one time.
3. During the test period, verify that the function associated with the selected relay(s) occurred as expected.
4. The Relay test will disable automatically after 1 minute.

### 3.3.2 Analog Outputs

The **Analog Outputs** screen displays the current values of the various analog outputs and allows you to manually adjust their values.

1. Go to: **Main Menu → Diagnostics → Analog Outputs and Relays → Analog Outputs.**



DEFAULT MODE

MANUAL MODE

**Figure 3.3.2: Analog Outputs and Relays: Analog Outputs Screen**

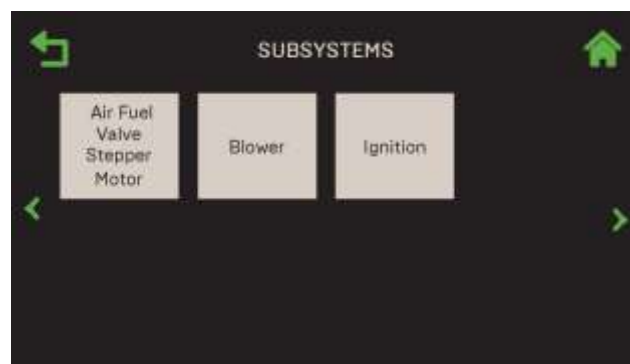
2. In Default mode, this screen is grey and displays the current value (read-only) of all analog outputs.
3. If you press the **Manual** button, the unit's fire rate is reduced to zero and the sliders turn green. You can now manually adjust the position of one or more of the outputs and verify the behavior of the selected output(s). You can return all sliders to 0.00 by pressing the **Zero** button.
4. To put this screen back in Default mode, press the **Manual** button again.

## 3.4 Subsystems

The **Subsystems** screens allows you to test the units Air/Fuel Valve, Blower and Ignition.

**NOTE:** You can navigate from one **Subsystem** screen to the next in round-robin fashion using the **Page Left** and **Page Right** icons on each screen.

1. Go to: **Main Menu → Diagnostics → Subsystems.**



**Figure 3.4: Diagnostics: Subsystems Screen**

2. Press on the component you want to test.

### 3.4.1 Air Fuel Valve Stepper Motor

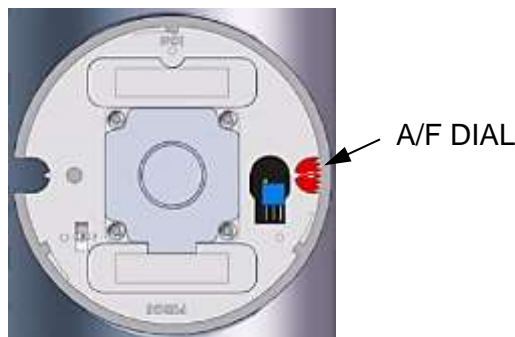
Complete the instructions below to test the Air/Fuel Valve's stepper motor.

1. Go to: [Main Menu](#) → [Diagnostics](#) → [Subsystems](#) → [Air Fuel Valve Stepper Motor](#).



**Figure 3.4.1-1: Subsystems: Air Fuel Valve Stepper Motor Test Screen**

2. Press the **Auto-Stroke** control to initiate the test. This will start one full cycle of the Air Fuel Valve, from fully closed to fully open then back to closed. During the test, the valve position is displayed from 0% to 100%.



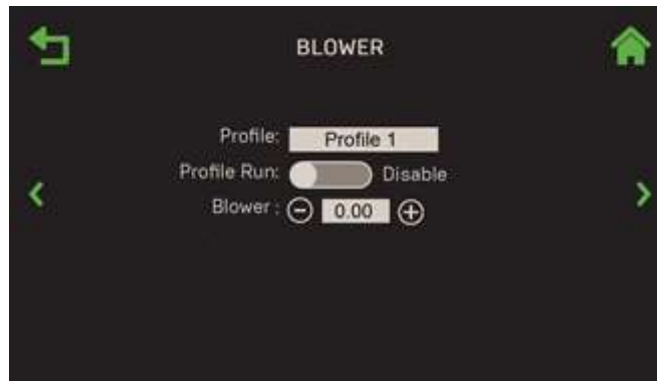
**Figure 3.4.1-2: Subsystems: Air Fuel Valve**

3. Alternatively, you can manually increment the Air Fuel Valve position in 1% increments using the **Plus** and **Minus** buttons and compare the stepper motor's physical position to the value on the screen.

### 3.4.2 Blower

Complete the instructions below to test the Blower motor.

1. Go to: [Main Menu](#) → [Diagnostics](#) → [Subsystems](#) → [Blower](#).



**Figure 3.4.2: Subsystems: Blower Screen**

2. The **Blower** screen allows you manually drive the blower to a desired RPM using the **Plus** or **Minus** buttons on the **Blower** (voltage) control, or you can run a pre-defined sequence.
3. To run the blower manually, use the **Plus** or **Minus** buttons or press the numeric field and input a blower voltage, then verify by observing the blower speed.
4. To run a pre-defined sequence, press the **Profile** parameter and select **Profile 1**, then enable the **Profile Run** control. This profile exercises the Blower in increments from 0 to 10 volts then back to 0.
5. Using either method, **Blower** (voltage) and **Blower** (rpm) are displayed continuously.

### 3.4.3 Ignition

Complete the instructions below to test the ignition system. Note, the Safety Shutoff Valve does not open during this test.

1. Go to: [Main Menu](#) → [Diagnostics](#) → [Subsystems](#) → [Ignition](#).



**Figure 3.4.3: Subsystems: Ignition Screen**

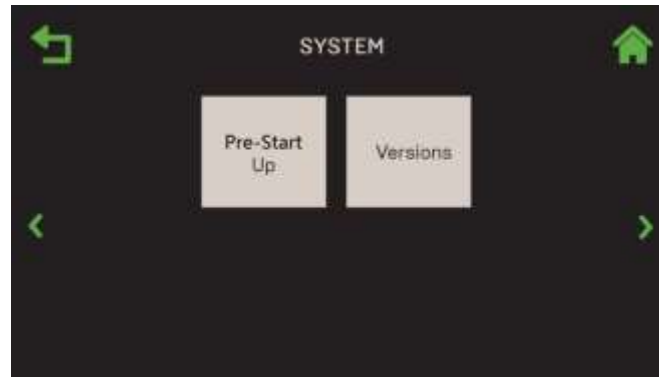
2. Start the **Ignition Spark** test by enabling its control.
3. The Igniter Solenoid opens the gas assist line solenoid and generates sparking of the igniter until the **Ignition Spark** control is disabled. The **Spark Current** is displayed continuously during the test.



## 3.5 System

From the **System** screen you can run a programmable profile, manually ramp the fire rate up or down, perform a pre-startup diagnostic or view a software version summary.

1. Go to: **Main Menu** → **Diagnostics** → **System**.



**Figure 3.5: Diagnostics: System Screen**

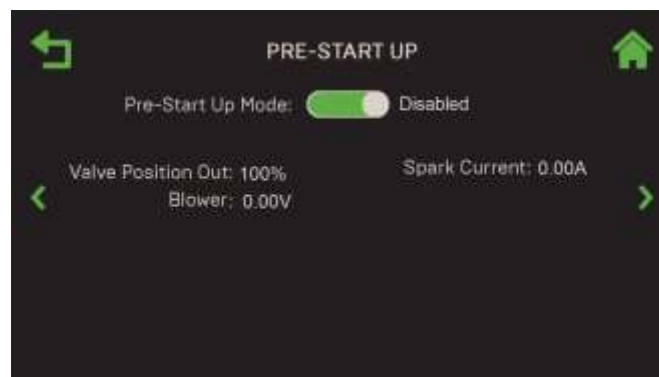
**NOTE:** You can navigate from the **Pre-Start Up** screen to **Versions** in round-robin fashion using the **Page Left** and **Page Right** icons on each screen.

### 3.5.1 Pre-Start Up

The **Pre-Start Up** screen allows you verify various system components and assemblies without opening the SSOV. This is particularly useful when the building's gas supply has not been turned on and you want to make sure everything will function when the gas supply is turned on.

Complete the instructions below to run Pre-Start Up diagnostic tests.

1. Go to: **Main Menu** → **Diagnostics** → **System** → **Pre-Start Up**.



**Figure 3.5.1: System: Pre-Start Up Screen – Shown Disabled**

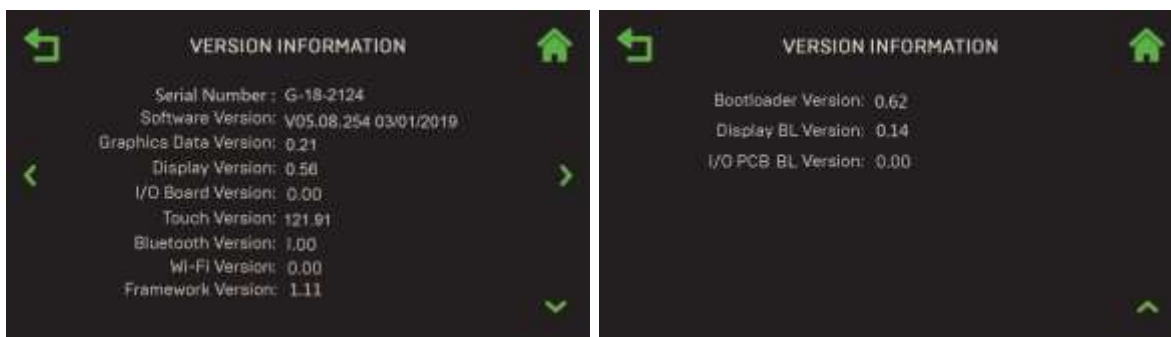
2. To run the Pre-Startup test, enable the **Pre-Start Up Mode** control. The following occurs:
  - The valve position moves to ignition position.
  - The Blower is turned on at ignition point voltage.

- The gas assist solenoid opens.
  - The igniter is sparked.
3. Monitor the valve position out, blower voltage and spark current.
  4. When observations have completed, disable the **Pre-Start Up Mode** control.

### 3.5.2 Versions

The **Version Information** screens displays the current version of the Edge Controller's various firmware components.

1. Go to: **Main Menu → Diagnostics → System → Versions.**



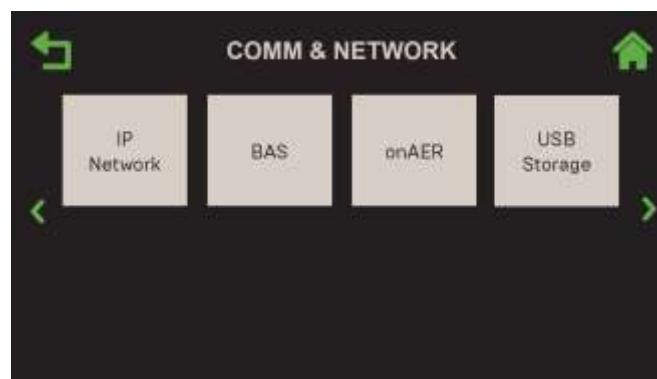
*Figure 3.5.2: System: Versions Information Screen*

2. The version of each component is displayed.

### 3.6 Comm & Network

The **Comm & Network** screen provides access to screens that can be used to verify IP, onAER and BAS communication, and available space on a USB device plugged into the side of the Edge Controller.

1. Go to: **Main Menu → Diagnostics → Comm & Network.**

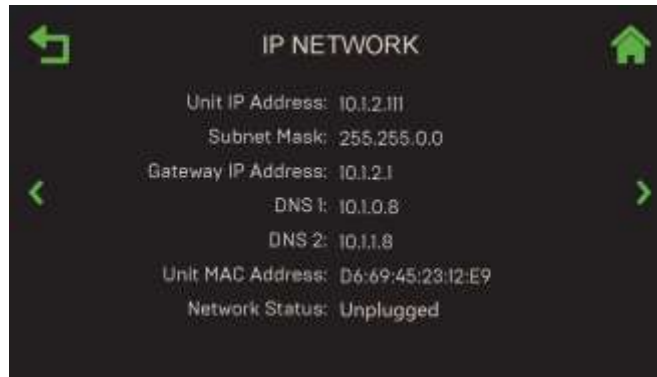


*Figure 3.6: Diagnostics: Communications Screen*

### 3.6.1 IP Network

The **IP Network** option is used to check the IP interface used by onAER or BAS.

1. Go to: **Main Menu → Diagnostics → Comm & Network → IP Network**.



**Figure 3.6.1: Comm & Network: IP Network Screen**

2. The status of the available parameters is displayed.

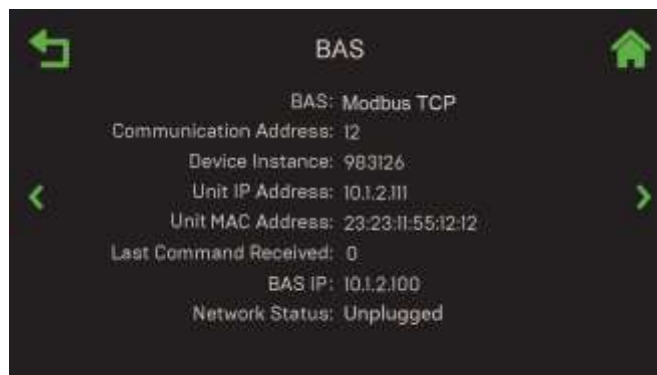
### 3.6.2 BAS – Innovation Only

**NOTE:**

This screen is available only on Innovation water heaters.

If the Innovation Water heater is part of a Building Automation System (BAS), the BAS screen provides a read-only display of various communication parameters. The screen that appears depends on the communication protocol specified in the **BAS** parameter (see Section 4.4.1: **Main Menu → Advanced Setup → Comm & Network → BAS**).

1. Go to: **Main Menu → Diagnostics → Comm & Network → BAS**.



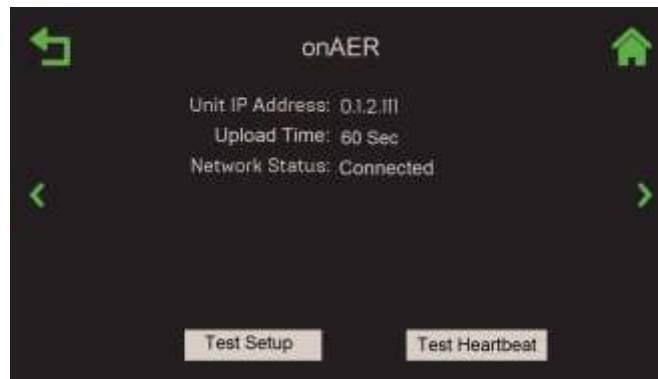
**Figure 3.6.2: Comm & Network: BAS Screen**

2. The status of the available parameters is displayed.

### 3.6.3 onAER

The **onAER** screen provides a read-only display of several onAER communication parameters and provides the option to perform two functionality and communication tests.

1. Go to: **Main Menu** → **Diagnostics** → **Comm & Network** → **onAER**.



**Figure 3.6.3: Comm & Network: onAER Screen**

2. This screen displays a number of different parameters. The specific parameters that appear depends on the value of the **onAER Mode** parameter (see [Section 4.4.2: Main Menu → Advanced Setup → Comm & Network → onAER](#)).
  - **Unit IP Address** (**onAER Mode** = Ethernet, Wifi or Wiznet): Displays the unit's IP Address
  - **Upload Time** (**onAER Mode** = Ethernet, Wifi or Wiznet): Displays the upload frequency selected in [Section 4.4.2: onAER](#).
  - **Network Status** (**onAER Mode** = Ethernet): Displays the status of the network connection.
3. There are two optional onAER functionality and communication tests, both of which send reports to the host server.
  - **Test Heartbeat**: The green onAER LED on the Edge Controller's front face blinks rapidly for one or two seconds while sending a summary status file to the host server.
  - **Test Setup**: The green onAER LED on the Edge Controller's front face blinks rapidly for several seconds while sending a full status file to the host server. Both buttons are greyed out until test completion.

### 3.6.4 USB Storage

If a USB device is plugged into the USB port on the Edge Controller's left side, the **USB Storage** screen displays various parameters about that device (if no devices is plugged in, the screen displays just the **Status** parameter).

1. Plug a USB device into the USB port on the Edge Controller's left side.
2. Go to: **Main Menu** → **Diagnostics** → **Comm & Network** → **USB Storage**.



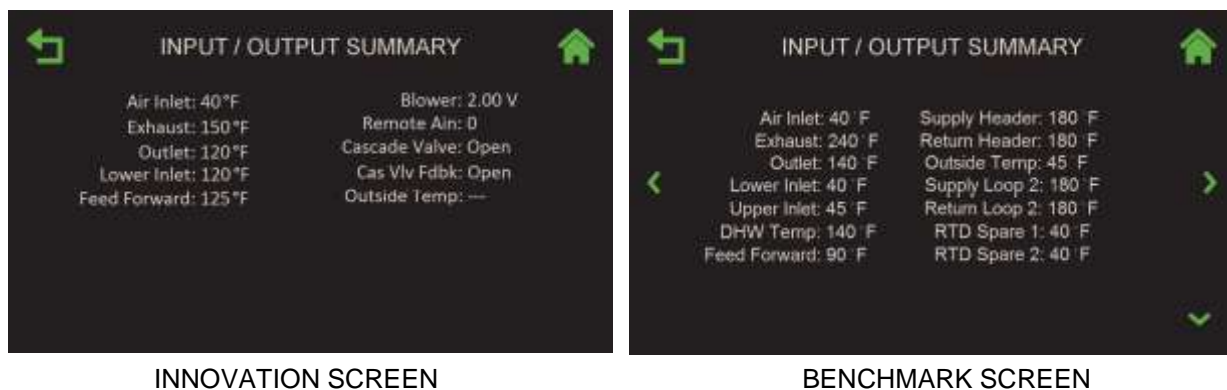
**Figure 3.6.4: Comm & Network: USB Storage Screen**

3. The status of the available parameters is displayed.

## 3.7 Input/Output Summary

The **Input/Output Summary** screen is a read-only, multi-page screen that displays the current status of all Inputs and Outputs, such as temperature sensors, pressure sensors, flow sensor, O<sub>2</sub> sensor, Analog Inputs and Analog Outputs. Items that are not part of the configuration are blank (---).

1. Go to: **Main Menu** → **Diagnostics** → **Input/Output Summary**.



**Figure 3.7: Input/Output: Input/Output Summary Screen**

SECTION 3: DIAGNOSTICS

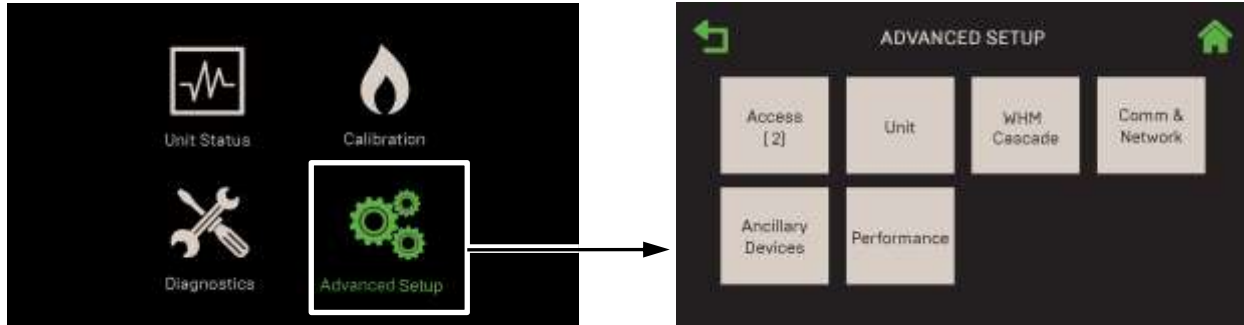
2. The following are examples of the data in the **Input/Output Summary** screen.

TABLE 3.7-1: Innovation Summary Parameters			
Air Inlet:	40°F	Blower:	2.00 V
Exhaust:	240°F	Remote Ain:	5.5
Outlet:	140°F	Cascade Valve:	5.5
Lower Inlet:	40°F	Cas Vlv Fdbk:	5.5V
Feed Forward:	90°F	Outside Temp	---

TABLE 3.7-2: Benchmark Summary Parameters			
Air Inlet:	40°F	Supply Header:	180°F
Exhaust:	240°F	Return Header:	180°F
Outlet:	140°F	Outside Temp:	40°F
Lower Inlet:	40°F	Supply Loop 2:	180°F
Upper Inlet:	40°F	Return Loop 2:	180°F
DHW Temp:	140°F	RTD Spare 1:	40°F
Feed Forward:	90°F	RTD Spare 2:	40°F
O <sub>2</sub> :	3%	Spare Aout2:	19
Spare Aout1:	5.5	Spare Aout3:	5.50V
Cascade Valve:	5.5	Blower:	2.00 V
BLR V.S. Pump:	5.5	DHW V.S. Pump:	5.5V
Flow:	0.0 gpm	CO/Analog In:	5.5V
Air Pump:	1.05 V	Cas Vlv Fdbk:	5.5V
Remote Ain:	5.5	Spare Ain1:	5.5V
Spare Ain2:	5.5	Spare Ain3:	5.5V
Blower Relay:	Open	Swing Valve 1 Relay:	Closed
Ignition Relay:	Open	Backup Relay:	Closed
Pump Relay:	Open	DHW Relay:	Closed
Aux Relay:	Open	V2/Spare 1 Relay:	Closed
Fault Relay:	Open	Spare 2 Relay:	Closed
Blower	2.00 V	Blower	0 rpm
High Gas Pressure:	13.5 in. W.C.	Low Gas Pressure:	2.2 in. W.C.
Draft Pressure:	-0.81 in. W.C.	Spare Pressure:	28.1 in. W.C.

# SECTION 4: ADVANCED SETUP

The **Advanced Setup** screen provides access to specific parameters. It is accessed by pressing **Advanced Setup** on the **Main Menu**.



**Figure 4.0: Advanced Setup Screen**

This Section includes the following topics:

<p><b><a href="#">4.1: Access</a></b></p> <p><b><a href="#">4.2: Unit</a></b></p> <ul style="list-style-type: none"> <li><a href="#">4.2.1: Unit Settings</a></li> <li><a href="#">4.2.2: Front Panel Configuration</a></li> <li><a href="#">4.2.3: Save and Transfer Settings</a></li> <li><a href="#">4.2.4: Fault Management</a></li> <li><a href="#">4.2.5: Freeze Protection</a></li> <li><a href="#">4.2.6: Unit Application Configuration</a></li> <li><a href="#">4.2.7: Firmware Update</a></li> <li><a href="#">4.2.8: Maintenance</a></li> </ul> <p><b><a href="#">4.3: WHM Cascade-BST Cascade</a></b></p> <ul style="list-style-type: none"> <li><a href="#">4.3.1: Cascade Configuration</a></li> <li><a href="#">4.3.2: Cascade Communication</a></li> <li><a href="#">4.3.3: WHM &amp; BST Application Configuration</a></li> <li><a href="#">4.3.4: Operating Controls</a> <ul style="list-style-type: none"> <li><a href="#">4.3.4.1: Sequencing Controls</a></li> <li><a href="#">4.3.4.2: Anti-Cycling Control</a></li> <li><a href="#">4.3.4.3: Temperature Control – BMK Only</a></li> <li><a href="#">4.3.4.4: Valve Configuration</a></li> <li><a href="#">4.3.4.5: Setpoint Range – BMK Only</a></li> <li><a href="#">4.3.4.6: Lead/Lag</a></li> </ul> </li> </ul>	<p><b><a href="#">4.4: Comm &amp; Network</a></b></p> <ul style="list-style-type: none"> <li><a href="#">4.4.1: BAS (Building Automation System) – INN Only</a></li> <li><a href="#">4.4.2: onAER</a></li> <li><a href="#">4.4.3: Ethernet</a></li> <li><a href="#">4.4.4: Communication Failsafe</a></li> </ul> <p><b><a href="#">4.5: Ancillary Device</a></b></p> <ul style="list-style-type: none"> <li><a href="#">4.5.1: Interlocks</a></li> </ul> <p><b><a href="#">4.6: Performance</a></b></p> <ul style="list-style-type: none"> <li><a href="#">4.6.1: Temperature Controls</a> <ul style="list-style-type: none"> <li><a href="#">4.6.1.1: PID Setting</a></li> <li><a href="#">4.6.1.2: Temperature Conformance</a></li> <li><a href="#">4.6.1.3: Setpoint Range</a></li> <li><a href="#">4.6.1.4: FFWD Settings – INN Only</a></li> </ul> </li> <li><a href="#">4.6.2: Fire Control</a> <ul style="list-style-type: none"> <li><a href="#">4.6.2.1: Purge Control</a></li> <li><a href="#">4.6.2.2: Ignition Control</a></li> <li><a href="#">4.6.2.3: Operating Control</a></li> <li><a href="#">4.6.2.4: Anti-Cycling Control</a></li> </ul> </li> </ul>
---	--

**WARNING:**

Before starting the instructions in this section for the first time, you must ensure that the unit has the latest Edge Controller firmware. Complete the instructions in [Section 4.2.7: Firmware Update](#) to obtain and install the latest firmware.

## 4.1 Access

The **Enter Password** screen allows you to log in to the system. As mentioned in Section 1.5, there are multiple passwords, each granting a specific level of access.



**Figure 4.1: Advanced Setup: Enter Password Screen**

1. Go to: **Main Menu** → **Advanced Setup** → **Access**. The **Enter Password** screen appears.
2. The password for AERCO Trained Technicians is **159**. Enter **159** or the password you have been given, then press **Save**.

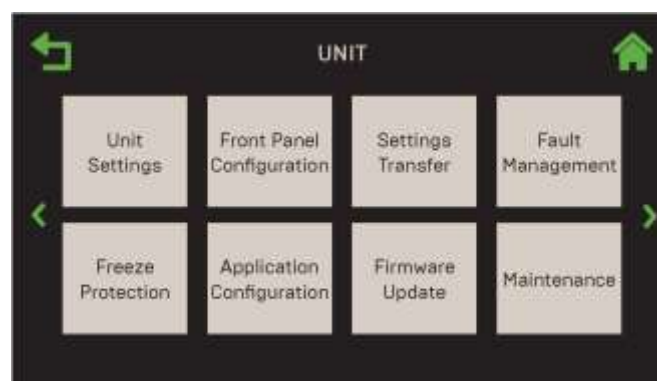
## 4.2 Unit

The **Unit** screen provides access to parameters specific to the single unit. Note, some parameters were set at the factory prior to shipping and cannot be changed.

**NOTE:**

You can navigate from one **Unit** screen to the next in round-robin fashion using the **Page Left** and **Page Right** icons on each screen.

1. Go to: **Main Menu** → **Advanced Setup** → **Unit**.



**Figure 4.2: Advanced Setup: Unit Screen**

**NOTE:**

The Application Configuration button is enabled only if **WHM Unit Mode** (Innovation) or **Unit Mode** (Benchmark) (see the **WHM Unit Mode** parameter in [Section 4.3.1.1: Cascade Configuration – Innovation](#), or the **Unit Mode** parameter in [Section 4.3.1.2: Cascade Configuration – Benchmark](#)) = **Off**.



## 4.2.1 Unit Settings

The **Unit Settings** screens displays a list of parameters and controls on several pages. Many of the parameters were set at the factory before shipping and should not be changed.

1. Go to: **Main Menu** → **Advanced Setup** → **Unit** → **Unit Settings**.



INNOVATION SCREENS

BENCHMARK SCREENS

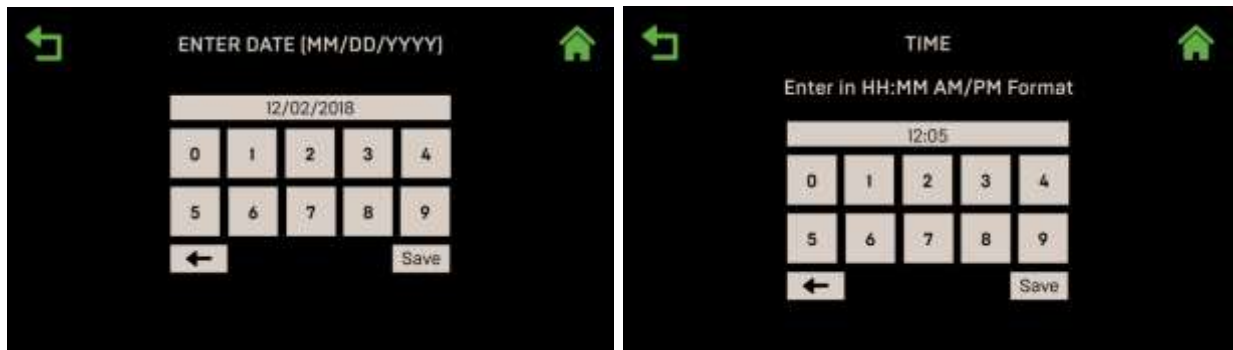
**Figure 4.2.1-1: Unit: Unit Settings Screens**

2. The following parameters are available:

- **Unit Serial #:** Displays the unit's factory-set serial number in a unique format of G-YY-ZZZZ or N-YY-ZZZZ. Do **NOT** change unless replacing the Edge Controller. The format is:
  - **G:** A letter specific to Innovation Water Heaters and Benchmark Boiler models 750-4000, or letter **N** for BMK 5000 and 6000.
  - **YY:** The two-digit year
  - **ZZZZ:** A sequential 4-digit serial number.

SECTION 4 – ADVANCED SETUP

- **Unit Type:** Displays AERCO products and models, such as Innovation WH, Benchmark Boilers and KC Water Heaters. Do **NOT** change unless replacing the Edge Controller.
- **Unit Size:** Displays available sizes for the given **Unit Type**. Do **NOT** change unless replacing the Edge Controller.
- **Date, Time, Time Format:** Allows you to set the date and time. The **Time Format** control allows you to select 12 or 24 hour format.



**Figure 4.2.1-2: Unit: Enter Date & Time Screens**

- **Vent Type:** Choose the unit’s exhaust vent material: **PVC, cPVC, Polypro** or **Stainless Steel**.
- **Exhaust Safety:** If Enabled, this parameter protects the unit and exhaust vent from excessively high exhaust temperatures. When exhaust temperature exceeds any of three limits, an action is taken, as shown in the table below. The limits depend on the vent material specified in **Vent Type** (Stainless Steel has no limit).

TABLE 4.2.1: Exhaust Safety Temperature Limits				
Limit Type	Result Action	Vent Material		
		PVC	cPVC	Polypro
Caution Limit	Display Warning	158°F	210°F	215°F
High Temp Limit	Reduce Fire Rate	170°F	220°F	220°F
Fault Limit	Unit Shut Down	180°F	230°F	230°F

- **Fuel Type** (not available for all unit types): Choose either **Natural Gas** or **Propane**.
- **Control Type:** Displays the Edge Controller type: **Edge [i]**. It can be changed on Benchmark units to **Edge [ii]**. Do **NOT** change unless replacing the Edge Controller.
- **Unit of Measurement:** Choose the unit of measure the Edge Controller will display, either **Metric** (°C, lps, Pa) or **English** (°F, gpm, in. W.C., psi). The corresponding LED indicator on the Edge Controller’s front face, °F or °C, lights (see Figure 4.2.2-1, below).
- **Temperature Sensor:** Specifies the sensor type: **PT1000** or **BALCO**. Note, the default is BALCO on all units. Do **NOT** change unless replacing a on a legacy unit equipped with a different sensor.

- **Standby Pump On Time (Innovation Only):** The amount of time internal recirculation pump runs when unit is in standby. Pump has a continual operation. (Range: 0 to 20 min.)
- **Standby Pump Off Time (Innovation Only):** The amount of time internal recirculation pump is disabled during unit standby. Pump is continually cycled during standby. (Range: 0 to 30 min.)
- **Post-Fire Pump Time (Innovation Only):** The amount of time internal recirculation pump runs after unit has entered standby mode. (Range: 0 to 30 min.)
- **Beeper:** Enables/disables the audible fault alarm.
- **Run Cycles/Run Hours:** Displays the number of run hours/run cycles since the last system reset. Both can be reset to 0 (or any other number).
- **Reset All Settings:** To reset *all* settings to their default values, press **Yes**, then press **Yes** again when asked to confirm.
- **Reset Common Settings (Benchmark only):** To reset *common* settings to their default values, press **Yes**, then press **Yes** again when asked to confirm.
- **Clear Fault Log:** To clear the Unit Event History (see [Section 5.5 Unit Event History](#)), press **Yes**, then press **Yes** again when asked to confirm.

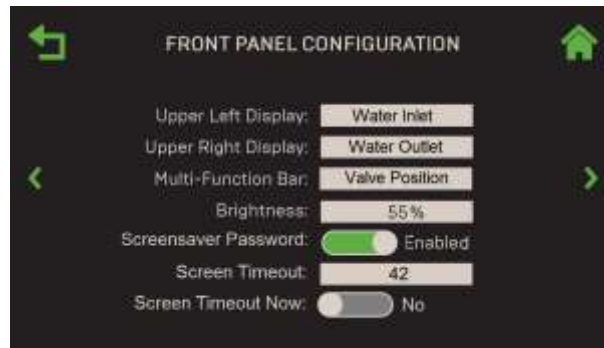
## 4.2.2 Front Panel Configuration

The **Front Panel Configuration** screen allows you to modify the Edge Controller's front panel and the touchscreen timeout setting.



**Figure 4.2.2-1: Unit: Edge Controller Front Panel – Upper Portion**

1. Go to: **Main Menu** → **Advanced Setup** → **Unit** → **Front Panel Configuration**.



**Figure 4.2.2-2: Unit: Front Panel Configuration Screen**

2. The following fields are available:

- **Upper Left Display:** Choose between: **Feedforward**, **Setpoint** or **Water Inlet**. If you chose **Setpoint** or **Water Inlet**, a green ▼ icon appears on the Edge Controller's front face next to your choice; if you chose **Feedforward**, the green ▼ icon disappears.
- **Upper Right Display:** Choose between: **Water Outlet** and **System Header**; a green ▼ icon appears on the Edge Controller's front face above next to your choice.
- **Multi-Function Bar:** Choose what the Multi-Function Bar displays: **Fire Rate** or **Valve Position**.
- **Brightness:** Touchscreen brightness. Even when set to 10%, the touchscreen is never completely dark. (Range: 10 to 100%)
- **Screensaver Password:** Determines whether *all* users are required to enter a password to access the Edge Controller, even Password Level 0 items. See [Section 1.5 Passwords](#). If set to **Enabled**, the following additional parameters appear:
  - **Screen Timeout:** Specifies touchscreen timeout. (Range: 3 to 90 min.)
  - **Screen Timeout Now:** Setting to **Yes** immediately puts the screen into sleep mode, causing the **Enter Password** screen to appear.

### 4.2.3 Save and Transfer Settings

The Edge Controller includes functionality for saving a unit's current setup, which creates a backup of the state of all user-configurable parameters. It can be saved to either:

- The Edge Controller's internal memory
- To a USB device plugged into the USB port on the side of the Edge Controller.

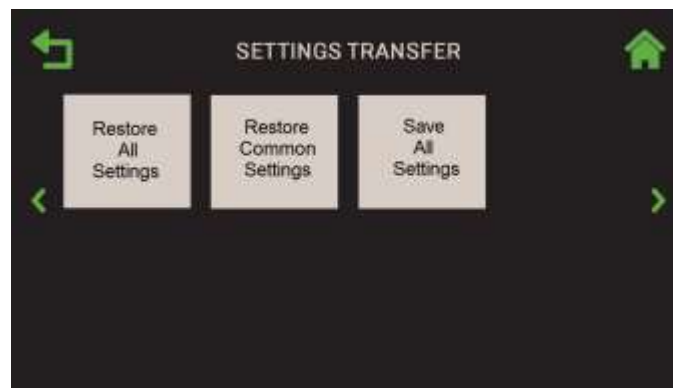
Once saved, the complete setup can be restored on the same unit or transferred to one or more other units. This second option is particularly useful when setting up a WHM Cascade; the first "client" unit is setup, configured and fully tested, then its setup is transferred to all the other "client" units **of the same unit type**. It can also be used to recover if a setup becomes corrupted, either through hardware malfunction or operator error.

**WARNING:**

When transferring to/from WHM or BST Client or Manager units, note the following:

- Client and Manager units use separate setup files; **Client** units require a **Client** setup file, and **Manager** units require a **Manager** setup file.
- If loading the setup from a USB device, the device can have only **Client** *or* **Manager** setup files on it, but **cannot** have both files *on the same device*.
- When saving a setup file, each unit produces a file with a unique name based on unit serial number; that name never changes. A USB device can have multiple Client or Manager setup files (but not both) for multiple units, but only one for each unit. Creating a new setup file on the Edge Controller's memory or a USB device will overwrite the existing copy.

1. Go to: **Main Menu** → **Advanced Setup** → **Unit** → **Settings Transfer**.



**Figure 4.2.3: Unit: Settings Transfer Screen**

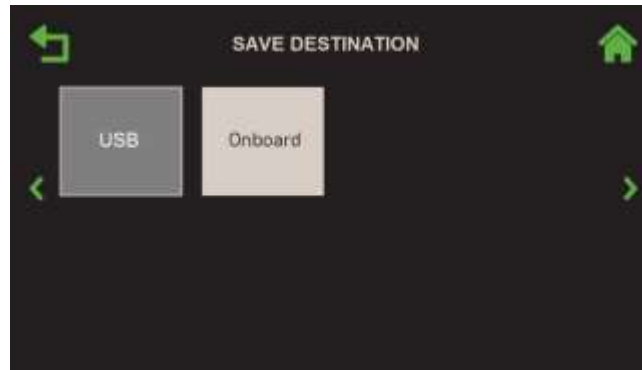
2. Choose one of the following:

- To **save** the current settings, press **Save All Settings** and then complete the instructions in [Section 4.2.3.1: Save Settings](#). AERCO strongly recommends using this option periodically to guard against the need to perform a time-consuming recreation of the original setup
- To **restore** settings, choose one of the **Restore** options and then complete the instructions in [Section 4.2.3.2: Restore Settings](#).
  - **Restore All Settings:** This is appropriate when restoring settings that were saved on a unit and are only appropriate for that unit.
  - **Restore Common Settings:** Restores the settings that are common to all units of the same type. This is appropriate when one unit has already been setup and you want to copy all its settings and parameters to additional units of the same type in a WHM or BST Cascade.

### 4.2.3.1 Save Settings

If you chose **Save All Settings** in the previous section, complete the following steps to save the unit's current setup, which includes the current state of all settings/parameters.

1. The **Save Destination** screen appears. This option saves all of the unit's settings and configurable parameters.



**Figure 4.2.3.1: Unit: Save Destination Screen**

2. Chose where you want to save the current settings:
  - **Onboard**: Saves the current setup file to the Edge Controller's onboard memory.
  - **USB**: This option is available only if an unencrypted USB device is plugged into the Edge Controller's USB port; if no USB device is plugged in, it is greyed-out, as shown above. You can use the same USB device used in Section 4.2.7.1 to obtain the latest firmware.

**NOTE:**

Each unit produces a setup file with a unique name based on the unit's serial number. If that setup file has already been saved to the Edge Controller's memory or a USB device, **this step will overwrite it!**

3. If the setup was successfully saved, the **Save Succeeded** screen appears; press **Continue** to proceed. If it failed, a **Save Unsuccessful** screen appears. If successful, press **Continue** to proceed.

### 4.2.3.2 Restore Settings

If you chose **Restore All Settings** or **Restore Common Settings** in Section 4.2.3, one of the following screens appears:



Restore ALL Settings Option

Restore COMMON Settings Option

**Figure 4.2.3.2-1: Unit: Restore Source/Common Screens**

1. Choose where the setup was saved (see [Section 4.2.3.1: Save Settings](#)):
  - **USB:** If the setup was saved to a USB device plugged into the Edge Controller's USB port.
  - **Onboard:** If the setup was saved to the Edge Controller's onboard memory.
  - **Factory Settings:** Restores the original setup performed at the factory, overwriting parameters that were manually configured after the unit was installed.

#### **WARNING!**

**THE NEXT STEP WILL OVERWRITE THE PREVIOUS SETUP!**

2. The **Overwrite Calibration** screen now appears. Pressing either **Yes** or **No** will restore the settings, overwriting the existing settings. If you press **Yes**, this will include the results of the most recent combustion calibration. However, if you press **No**, the most recent combustion calibration data is retained.



**Figure 4.2.3.2-2: Unit: Overwrite Calibration Screen**

3. The **Restore Succeeded** screen appears if the restore was successful, and the unit then reboots in about 5 seconds. If there was a problem, the **Restore Failed** screen appears.



## 4.2.4 Fault Management

The **Fault Management** screen controls whether the reset mode for three fault conditions is automatic or manual.

1. Go to: **Main Menu** → **Advanced Setup** → **Unit** → **Fault Management**.



**Figure 4.2.4: Unit: Fault Management Screen**

2. Choose the desired reset mode, **Manual** or **Automatic**, for all three fault conditions.
  - **Power Reset:** Loss of electrical power.
  - **Water Temp Reset:** Supply water temperature exceeds specified tolerance. This applies only to the internal settings of the Edge Controller, **not** to the Manual High Temp Safety Limit switch.
  - **Gas Pressure Reset:** Gas pressure exceeds or drops below specified tolerance (model specific).

## 4.2.5 Freeze Protection

The **Freeze Protection** functionality will turn on the system pump and fire the unit if ambient temperature falls below specified values, thus reducing the risk of freeze damage.

1. Go to: **Main Menu** → **Advanced Setup** → **Unit** → **Freeze Protection**.



**Figure 4.2.5: Unit: Freeze Protection Screen – Freeze Protection Enabled**



2. To enable Freeze Protection functionality, set **Freeze Protection** to Enabled.
3. Once **Enabled**, the following additional parameters appear, which determine when the unit will shut off and restart:
  - **Pump On Temperature:** Specify the ambient temperature below which the system pump will be triggered to start. (Range: 20 to 245°F)
  - **Unit On Temperature:** Specify the ambient temperature below which the unit will be triggered to start firing. (Range: 20 to 245°F)
  - **Stop Temperature:** Specify the ambient temperature above which the unit will return to normal operation. (Range: 20 to 245°F)

## 4.2.6 Unit Application Configuration

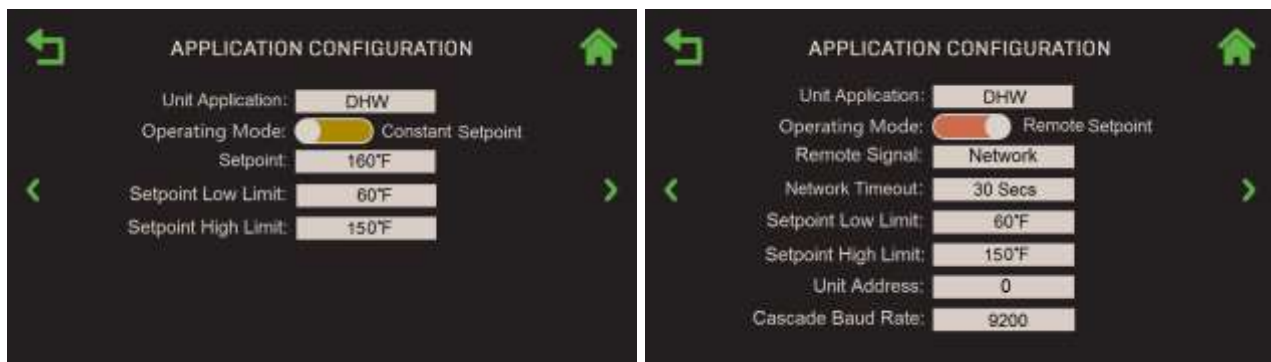
The Application Configuration screen contains operating mode, temperature and setpoint parameters for “standalone” Innovation and Benchmark units.

### 4.2.6.1 Unit Application Configuration - Innovation

**NOTE:**

This option is available only if **WHM Unit Mode = Off** in [Section 4.3.1.1: Cascade Configuration – Innovation](#).

1. Go to: **Main Menu** → **Advanced Setup** → **Unit** → **Application Configuration**.
2. Choose the **Operating Mode** for the unit, either **Constant Setpoint** or **Remote Setpoint** (note, the **Unit Application** for all Innovation Water Heaters is **DHW**).



Operating Mode = Constant Setpoint

Operating Mode = Remote Setpoint

**Figure 4.2.6.1: Unit: Application Configuration**

3. The following parameters appear regardless of the **Operating Mode** chosen:
  - **Setpoint Low Limit:** Specify the Setpoint’s *lower* limit. (Range: 40°F to 245°F)
  - **Setpoint High Limit:** Specify the Setpoint’s *upper* limit. (Range: 20°F to 220°F)

4. If **Operating Mode = Constant Setpoint**, the **Setpoint** parameter appears. Specify the setpoint for the unit. (Range: 60°F to 150°F)
  - If **Operating Mode = Remote Setpoint**, the following additional parameters appear:
    - **Network Timeout:** The timeout value before a Modbus Fault is declared due to no response from the BAS. (Range: 5 to 999)
    - **Remote Signal:** Choose the source of the remote signal:
      - 4-20mA
      - PWM Input
      - 1-5V
      - BAS
      - 0-20mA
      - Network
      - 0-5V
    - If **Remote Signal = Network**, the following additional parameters appear:
      - **Unit Address:** Set to the unit number of the signal source. (Range 0 to 16)
      - **Cascade Baud Rate:** Choose 9600, 19200, 38400 or 57600.

#### 4.2.6.2 Unit Application Configuration – Benchmark

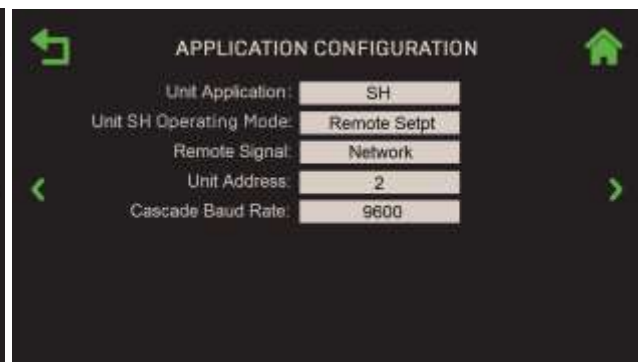
**NOTE:**

This option is disabled (greyed out) if **Unit Mode = BST Client** or **BST Manager** in [Section 4.3.1.2: Cascade Configuration – Benchmark](#); it appears only if **Unit Mode = Off**.

1. Go to: **Main Menu** → **Advanced Setup** → **Unit** → **Application Configuration**.
2. Choose the **Unit Application** for this unit: **SH** or **Other**.



Unit Application = SH



Unit Application = Other

**Figure 4.2.6.2-1: Unit: Application Configuration**

3. If you chose **SH** in Step 2, choose appropriate the **Unit SH Operating Mode** for the unit:
  - Constant Setpoint
  - Remote Setpoint
  - Direct Drive
  - Combination
  - Outdoor Reset

SECTION 4 – ADVANCED SETUP

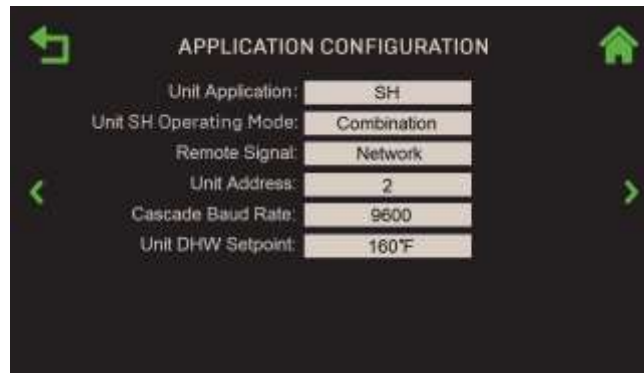
4. Depending on the **Unit SH Operating Mode** chosen in Step 3, a number of additional parameters appear, as shown in the table below.

TABLE 4.2.6.2: Parameters Available per Operating Mode					
Available Parameters	Unit SH Operating Modes				
	Constant Setpoint	Remote Setpoint	Direct Drive	Combination	Outdoor Reset
Unit SH Setpoint	✓				
Remote Signal		✓	✓	✓	
Unit Address <sup>1</sup>		✓	✓	✓	
Cascade Baud Rate <sup>1</sup>		✓	✓	✓	
Unit DHW Setpoint				✓	
Outdoor Air Temp Sens					✓
BST Outdoor Temp <sup>2</sup>					✓
OAR Min Outside Temp					✓
OAR Max Setpoint					✓
OAR Max Outside Temp					✓
OAR Min Setpoint					✓
Outdoor Rst Setpt					✓
Warm Weather Shtdwn <sup>2</sup>					✓

<sup>1</sup> Remote Signal = Network

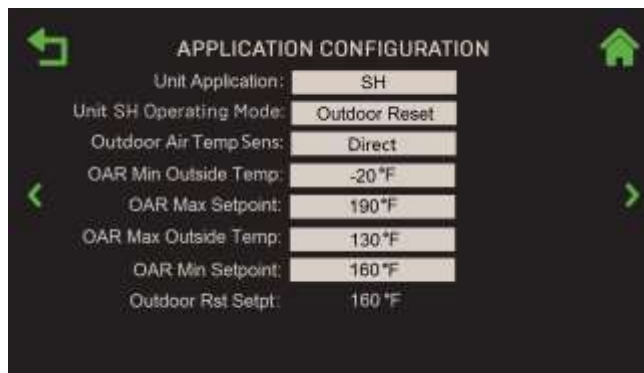
<sup>2</sup> Outdoor Air Temp Sens ≠ OFF

- A. If **SH Operating Mode = Constant Setpt**, the **Unit SH Setpoint** parameter appears; specify the space heating setpoint. (Range: 60°F to 180°F)
- B. If **SH Operating Mode = Remote Setpt, Combination or Direct Drive**, the **Remote Signal** parameter appears. Choose the source of the signal:
- 4-20mA
  - BST (PWM) Input
  - 1-5V
  - BAS
  - 0-20mA
  - Network
  - 0-5V
- If **Remote Signal = Network**, the following additional parameters appear:
    - **Unit Address:** Set to the unit number of the signal source. (Range 1 to 127)
    - **Cascade Baud Rate:** Choose **9600, 19200, 38400 or 115200**.
- C. If **SH Operating Mode = Combination**, the **Unit DHW Setpoint** parameter appears; specify the setpoint for DHW operation. (Range: 60°F to 180°F)



**Figure 4.2.6.2-2: Unit: Application Configuration, Application = SH**

- D. If **SH Operating Mode = Outdoor Reset**, the following OAR (outdoor air reset) parameters appear:



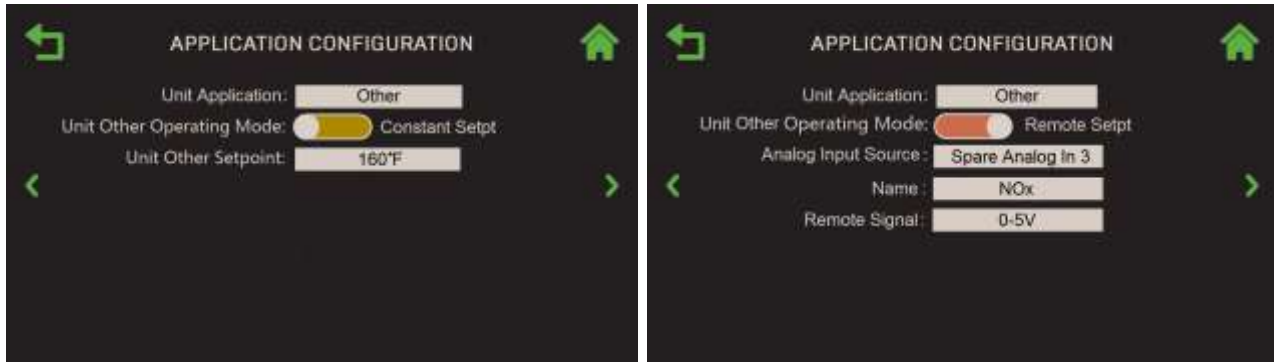
**Figure 4.2.6.2-3: Unit: Application Configuration, Application = SH**

- **Outdoor Air Temp Sens:** Choose the Outdoor Sensor signal type: **Network**, **Direct**, **BAS** or **Off**. For all options except **Off**, the following additional parameters appear:
  - **BST Outdoor Temp:** A read-only display indicating how the unit communicates with the Outdoor Air Temp Sensor.
  - **Warm Weather Shutdown:** The threshold outside temperature above which the unit shuts down. (Range: 30°F to 120°F)
- **OAR Min Outside Temp:** Specifies the minimum outside air temperature the system will read; it interacts with the OAR Max Setpoint. For example, if **OAR Min Outside Temp** is set to -5°F and **OAR Max Setpoint** is 180°F, when the outside temperature is -5°F or below, the system will supply 180°F. (Range: -40°F to 140°F, Default = -20°F)
- **OAR Max Setpoint:** The *maximum* allowable setpoint (Range: 20 or **OAR Min Setpoint** to 210°F, Default = 190°F)
- **OAR Max Outside Temp:** Outdoor Air Reset Maximum Outside Temperature that the system will operate to. For example: if set to 60°F, the boiler will operate between 60°F outside temperature and OAR Min Outside Temp setting. (Range: -40°F to 140°F, Default = 130°F)

SECTION 4 – ADVANCED SETUP

- **OAR Min Setpoint:** The *minimum* allowable setpoint. (Range: 20°F to 210°F or **Max Setpoint**, Default = 160°F)
- **Outdoor Rst Setpt:** A read-only display of the current outdoor reset setpoint, based on the four OAR parameters configured above.

5. If **Unit Application = Other**, choose one of two **Unit Other Operating Mode** for the unit.



Unit Other Operating Mode = Constant Setpoint      Unit Other Operating Mode = Remote Setpoint

**4.2.6.2-4: Unit: Application Configuration, Unit Application = Other**

- If **Unit Other Operating Mode = Constant Setpt**, the **Unit Other Setpoint** parameter appears. Specify the “other” setpoint in that parameter. (Range: 70°F to 180°F)
- If **Unit Other Operating Mode = Remote Setpt**, the following additional parameters appear:
  - **Analog Input Source:** Select the source for the Analog Input: **Spare Analog In 1, Spare Analog In 2, Spare Analog In 3.**
  - **Name:** Choose a name to associate with the analog input:
 

<input type="radio"/> Not Assigned	<input type="radio"/> Remote Setpt 2
<input type="radio"/> Swing V1 Fdbk	<input type="radio"/> Swing V2 Fdbk
<input type="radio"/> Blr VSP Fdbk	<input type="radio"/> DHW VSP Fdbk
<input type="radio"/> SmartPlate VP	<input type="radio"/> NOx

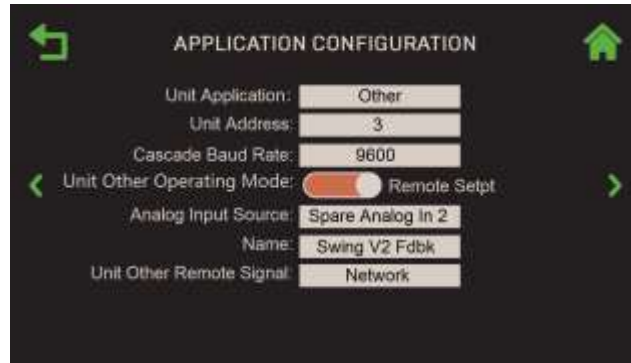
**NOTE:**

The **Analog Input Source** and **Name** parameters also appear in Step 5b, above. Changing them in either one changes them in the other.

- **Unit Other Remote Signal:** Choose the source of the signal:
 

<input type="radio"/> 4-20mA/1-5V	<input type="radio"/> Network
<input type="radio"/> 0-20mA/0-5V	<input type="radio"/> BAS

  - If **Unit Other Remote Signal = Network**, the following additional parameters appear:
    - **Unit Address:** Set to the unit number of the signal source. (Range 1 to 127)
    - **Cascade Baud Rate:** Choose **9600, 19200, 38400** or **115200.**



**Figure 4.2.6.2-5: Unit: Application Configuration, Unit Other Remote Signal = Network**

## 4.2.7 Firmware Update

When AERCO releases a new Controller firmware version, there are two options for obtaining it; both require the firmware to first be downloaded to a USB device:

**Option 1:** Download it to an external computer and then save it on a USB device – See [Section 4.2.7.2: Download to an External Computer](#).

**Option 2:** Download it via an Ethernet cable directly to a USB device plugged into the side of Controller – See [Section 4.2.7.3: Download Directly to a USB Plugged Into the Controller](#)

Once the firmware is on the USB device, that device is then plugged into the side of the Controller and the Controller then performs the update.

However, the procedure for upgrading the Edge Controller also depends on the current version of the BootLoader, a component used during firmware updates. The Edge Controller on all new Benchmark Boilers and Innovation Water Heaters are equipped with the latest AERCO Intelligent BootLoader (V1.00 or later), however some older Benchmark units may still contain the original BootLoader.

There are 3 ways to tell what BootLoader Version you have.

1. Go to **Main Menu → Diagnostic → System → Versions**. The BootLoader version is shown on the 2<sup>nd</sup> page of this screen.
2. If the BootLoader screen blinks white, the version is **older** than V1.00
3. While the BootLoader is running, its version is displayed in the top-left numeric display.

If your Controller has an older BootLoader, you can obtain the BootLoader Upgrade Kit, P/N **69335-10** from AERCO, then install it per the instructions in the Technical Instruction Document (TID-0219) included with the kit.

### NOTES:

A BootLoader update is not mandatory. The older BootLoader will work, however it will not be able to use named files shown below; instead it must always use the file named **edgelmage.hex**. Additionally, the unit may not support all USB device types. If the BootLoader update is not performed, ensure that your USB device works in the Edge Control by listening for the beep when it is inserted, or going to **Main Menu → Diagnostic → Comm and Network → USB Storage** and verify that the **Status** is **Present**.

The Intelligent BootLoader automatically distinguishes between Benchmark Boiler and Innovation Water Heater files loaded on the same USB device, and then loads the proper file for that unit. The Firmware file names are stored onto the USB device in the following format:

- BMK\_V509014\_Boiler Firmware
- INN\_V509014\_Water Heater Firmware

The Intelligent BootLoader looks for the appropriate file on the USB device **and** looks for the most recent version of that firmware. For Example, a USB device could contain the following files:

1. BMK\_V509014\_Boiler Firmware
2. BMK\_V509015\_Boiler Firmware
3. BMK\_V509016\_Boiler Firmware
4. INN\_V419017\_Water Heater Firmware



A Benchmark Boiler equipped with the Intelligent BootLoader will look for the Benchmark files and always pick Item #3, the BMK firmware file with the most recent version number. An Innovation Water Heater will look for and always pick item #4, the Innovation firmware file.

**NOTE:**

The Intelligent BootLoader is backward compatible with earlier firmware versions; it will load firmware files named **edgelmage.hex** if it can't find the relevant BMK or INN file.

In addition, the **Unit Settings** screen now contains a **Product Type** parameter, which displays either **BMK** or **INN**, depending on which firmware type is currently loaded.

### 4.2.7.1 Preparing for Firmware Update

Complete the following steps to save the unit's current setup, which includes the current state of all settings/parameters. The setup will be restored *only if necessary*, as described in [Section 4.2.7.5](#).

1. Remove the unit's front panel, to expose the USB port on the Controller's left side.
2. On the Edge Controller, go to: **Main Menu** → **Advanced Setup** → **Unit** → **Settings Transfer**.

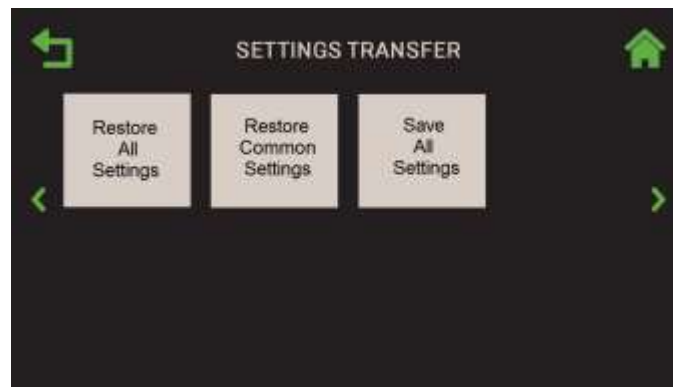


Figure 4.2.7.1-1: Unit: Settings Transfer Screen

3. Choose **Save All Settings**; the Save Destination screen appears.

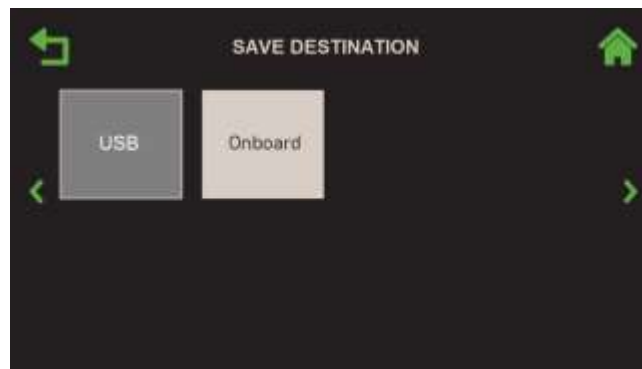


Figure 4.2.7.1-2: Unit: Save Source Selection

4. Choose where you want to save the current setup:
  - **Onboard:** Saves the current setup file to the Controller's onboard memory.



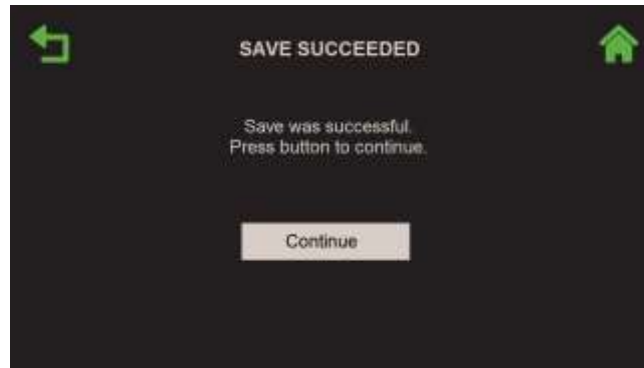
## SECTION 4 – ADVANCED SETUP

- **USB:** This option is available only if an un-encrypted USB device is plugged into the Controller's USB port; if no USB device is plugged in, it is greyed-out, as shown above.

**NOTE:**

Each unit produces a setup file with a name unique to that unit that never changes. If that setup file has already been saved to the Controller's memory or a USB device, **this step will overwrite that file.** However, a USB device can hold multiple setup files for multiple units.

5. If the setup was successfully saved, the **Save Succeeded** screen appears; press **Continue** to proceed. If it failed, a **Save Unsuccessful** screen appears.



**Figure 4.2.7.1-3: Save Succeeded Screen**

6. Before initiating the firmware update, write down the following important settings on a piece of paper or take a screenshot. You will do a spot check of these values after the update.
  - a. **Serial Number** and **Unit Type** in **Main Menu → Advanced Setup → Unit → Unit Settings**.
  - b. **Combustion Calibration Summary** in **Main Menu → Calibration → Combustion Summary**.
  - c. **Application Setup** in **Main Menu → EZ Setup**. See summary in first screen, then abort.
7. The Controller is now ready for the firmware update. Complete the instructions in *one* of the next two sections below, depending on how the firmware will be downloaded:
  - If the boiler/water heater connects directly to the Internet via an Ethernet cable or Wi-Fi , complete [Section 4.2.7.3](#).
  - If the boiler/water heater does ***not*** have a direct connect to the Internet, complete [Section 4.2.7.2](#).

#### 4.2.7.2 Download to an External Computer

If the unit does ***not*** have a direct connection to the Internet via Ethernet cable or Wi-Fi, an AERCO Trained Technicians (ATT) or AERCO Master Technicians (AMT) must download the firmware from the AERCO web site to an ***un-encrypted*** USB device on an external computer. If you are ***not*** an ATT or AMT, contact your local AERCO sales representative and request a copy of the latest Edge Controller firmware.

**WARNING:**

All instructions below ***must*** be carried out on a computer that can write to un-encrypted USB devices and ***must*** be performed using an ***un-encrypted*** USB device. Note, not all USB devices will work; they must be FAT32, and generally 32 GB or less (available from AERCO).

## SECTION 4 – ADVANCED SETUP

If you are an ATT or AMT, complete the following instructions to obtain the latest Edge firmware.

1. Plug the USB device into an external computer that can write to un-encrypted USB devices.
2. Go to the following URL: <http://learning.aerco.com>.
3. If you do not already have an account on this site, create one before continuing.
4. Scroll down the left navigation pane and open the **Edge Firmware** folder.
5. Copy the Edge Controller firmware file(s) (see [Section 4.2.7](#) for the naming convention) to the **root directory** of your USB device, not a sub-folder. If the folder contains updated **Graphics, I/O Board** and/or **Display** files, copy all these files to the root directory without changing their names (unless instructed to do so). If your unit has a BootLoader version *prior* to V1.00, you must download the file named **edgelimage.hex**.

**NOTE:**

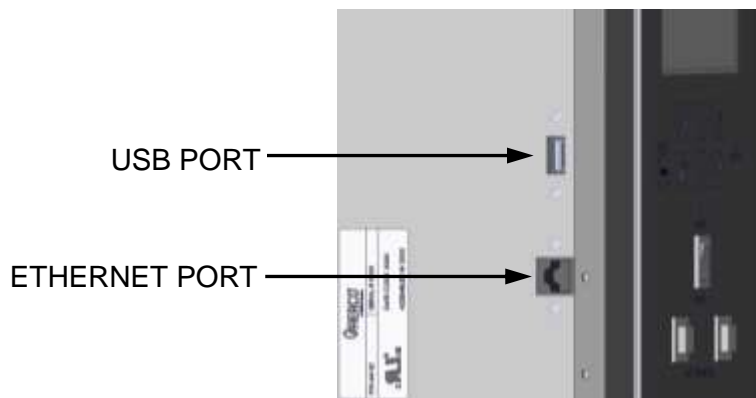
If your unit(s) all have the new Intelligent BootLoader (V1.00 or later), both Innovation and Benchmark files can be copied on to the same USB device. The download only needs to be performed once on a single USB device; that device can then be used to update all boilers and/or all water heaters.

6. You are now ready to update the Controller. Skip to [Section 4.2.7.4: Updating the Firmware](#). If needed, refer to the release notes for a running revision history.

### 4.2.7.3 Download Directly to the Controller

Complete the instructions below to download the latest firmware directly into the USB device plugged into the side of Controller. This option requires an **un-encrypted** USB device and an Ethernet cable capable of reaching the unit. Once the new firmware is copied to the USB device, it will be loaded into the Controller in [Section 4.2.7.4: Updating the Firmware](#). Note, this method saves the Innovation or Benchmark firmware update file(s) that are compatible with the Intelligent BootLoader V1.00 or later to the USB device. If you are updating a unit with an older BootLoader, it will save the file **edgelimage.hex** to the USB device.

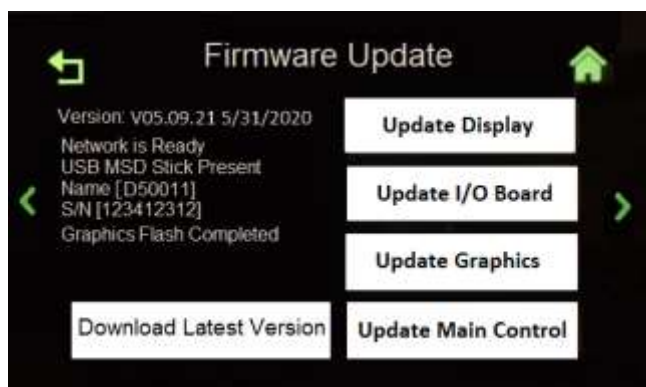
1. Remove the unit's front panel, to expose the USB port on the Controller's left side.
2. Insert an **un-encrypted** USB device in the USB port.
3. Plug an active Ethernet cable in the Ethernet port.



**Figure 4.2.7.3-1: USB Port Location**

4. Set the **Enable/Disable** switch on the Controller's front face to the **Disable** position.

5. Go to: **Main Menu → Advanced Setup → Access** and enter your password.
6. Go to: **Main Menu → Advanced Setup → Unit → Firmware Update**.
7. Press the **Download Latest Version** button. The firmware is copied from the Internet directly to the USB device installed in Step 2. This may take a minute or more. With the Intelligent BootLoader installed, this step also downloads updated graphics and/or I/O Board files, plus additional files, if there are any.
8. The Progress is displayed as the files are downloaded. Once completed, the screen displays **Downloads Complete**. If an error message is displayed, repeat the previous step, or complete the instructions in the previous section to download the file(s) to a USB device plugged into an external computer.



**Figure 4.2.7.3-2: Firmware Update Screen**

**NOTE:**

The download only needs to be performed once on a single USB device. That device can then be used to update all boilers and/or all water heaters.

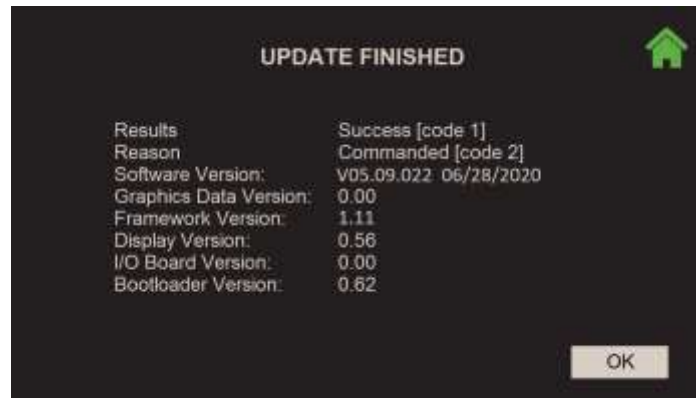
#### 4.2.7.4 Updating the Controller's Firmware

Complete the instructions below to update the firmware from the USB device used above.

1. Verify that the USB device containing the latest firmware is plugged into the Controller's USB port.
2. Verify that the **Enable/Disable** switch on the Controller's front face is set to **Disable**.
3. Go to: **Main Menu → Advanced Setup → Unit → Firmware Update** (enter your password if prompted; this screen requires a password). Note, the controls are disabled (greyed out) until the USB device is installed **and** the **Enable/Disable** switch is in the **Disable** position.
4. Press the **Update Main Control** button (see Figure 4.2.7.3-2, above).

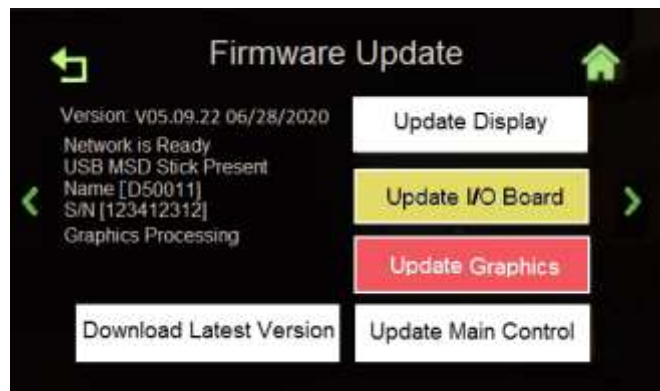
## SECTION 4 – ADVANCED SETUP

5. When done, the **Update Finished** screen appears displaying the new version number and the current date. **Do not remove the USB device until this screen appears.** Verify that the expected version and date is displayed. If so, press **OK** to continue.



**Figure 4.2.7.4-1: Update Finished Screen**

6. If there are updated **Graphics, I/O Board** or **Display** files, the associated button(s) will be colored red (update required) or yellow (update recommended). Press all red and yellow buttons to initiate the update; if you press more than one button, the Controller automatically starts the next update when the previous update completes. During each update, the associated button is greyed out. Do not remove the USB device until the **Update Finished** screen (Figure 4.2.7.4-1) appears.



**Figure 4.2.7.4-2: Graphics Processing Screen**

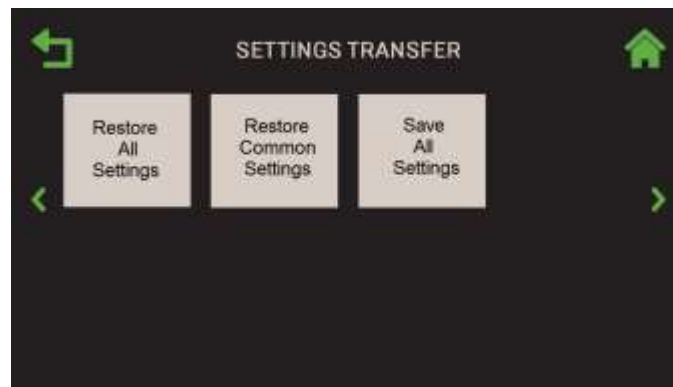
7. To ensure the firmware update was successful, you must now turn the boiler's power **OFF** and then back **ON**. Continue with the next step after restarting the boiler.
8. Once the Controller restarts, set the **Enable/Disable** switch back to **Enable** and remove the USB device. If there was a problem with the update, see [Section 4.2.7.6: Troubleshooting](#).
9. Spot-check that the values recorded at the end of [Section 4.2.7.1](#) are still in effect. This step should be performed whether or not the firmware update was successful.
  - a. **Serial Number** and **Unit Type** in [Main Menu](#) → [Advanced Setup](#) → [Unit](#) → [Unit Settings](#).
  - b. **Combustion Calibration Summary** in [Main Menu](#) → [Calibration](#) → [Combustion Summary](#).
  - c. **Application Setup**, in [Main Menu](#) → [EZ Setup](#). See summary in first screen, then abort.

10. If the spot-check is successful, the process is complete. But if any of the settings changed, or you suspect the setup was corrupted, complete the instructions in the next section, [Section 4.2.7.5: Restore Settings After Firmware Update](#).

### 4.2.7.5 Restore Settings After Firmware Update

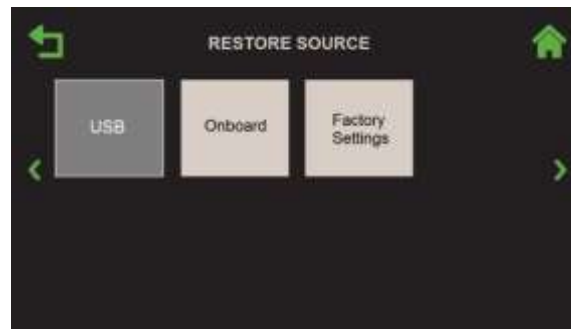
If the spot check in the previous section failed, you should restore the setup and its parameters to their original state prior to the update.

1. Go to: **Main Menu** → **Advanced Setup** → **Unit** → **Settings Transfer**.



**Figure 4.2.7.5-1: Settings Transfer Screen**

2. Choose **Restore All Settings**; the Restore Source screen appears.



**Figure 4.2.7.5-2: Restore Source Screens**

3. Choose where you saved the setup (in [Section 4.2.7.3](#)), then press either:
  - **USB** if the same USB device is still plugged in.
  - **Onboard** if the setup was saved to the Controller's onboard memory.
4. The **Overwrite Calibration** screen now appears. Press **Yes** to overwrite the existing combustion calibration values or press **No** to retain the existing values.



**Figure 4.2.7.5-3: Load Settings Screen**

5. The saved setup is restored to the unit. The **Restore Succeeded** screen appears if the transfer completed successfully, and the unit then reboots in about 5 seconds. If there was a problem, the **Restore Failed** screen appears.

### 4.2.7.6 Troubleshooting

The following are some of the issues that could arise during a firmware update, and their solutions.

1. The **Update** buttons are grayed-out:
  - a. The USB device is not recognized:
    1. The USB device is not inserted correctly. Remove and reinsert it.
    2. The USB device is not the correct type. Obtain the correct one.
    3. Update the Bootloader.
2. The display shows Bootloader File Not Found:
  - a. For pre V1.00 BootLoaders, the unit looks for the **edgelimage.hex** file.
  - b. For Benchmark units, it is looking for a file starting with BMK\_
  - c. For Innovation units, it is looking for a file starting with INN\_
  - d. Verify the correct file is on the disk.
  - e. Verify that **Advanced Setup → Unit → Unit Settings → Product Type** is correct.
3. The Bootloader starts but does not complete:
  - a. Check the Status code in the upper right LED Display:
    - i. **Code 5** - USB Device Not Found.
      1. The USB device is not the correct type. Obtain a correct one.
      2. Update the Bootloader.
      3. Cycle the power to restore the old program, since it is not yet erased.
    - ii. **Code 21** – File Not Found
      1. For Pre V1.00 Bootloaders, the unit is looking for the file **edgelimage.hex**.
      2. For V1.00 Benchmark units, it's looking for a file starting with BMK\_
      3. For V1.00 Innovation units, it's looking for a file starting with INN\_
      4. Verify the correct file is on the disk.
      5. Cycle the power to restore the old program, since it is not yet erased.
    - iii. **Code 22** – The Hex File is corrupted.

1. Recopy it to the USB device.
  2. Cycle the power to restore the old program, since it is not yet erased.
  - iv. **Code 23** - The Hex File is incomplete
    1. Recopy it to the USB device. Ensure it is fully copied. Try using the **Eject** feature on the Computer.
    2. If it was copied via the Edge Controller, verify that you received the complete file.
    3. Cycle the power to restore the old program, since it is not yet erased.
  - v. **Code 24** – 29 Programing Failure
    1. Programming Failed, Cycle the Power. The Bootloading will restart.
  - vi. **Code 30** - USB Device Removed.
    1. Do not touch or remove the USB device during programming.
    2. Cycle the Power. The Bootloading will restart.
4. Disaster Recovery:
- a. The unit will not run after bootloading. The screen could be off and the displays will be counting.
    - i. Turn off the power.
    - ii. Remove the top two screws from the Controller.
    - iii. Losen the bottom two screws.
    - iv. Allow the front panel to tilt out slightly.
    - v. Ensure a USB device with the correct firmware is inserted in the USB port.
    - vi. On the left side of the Controller the is a small button even with the center of the display. Press and hold this button while turning on the power.
    - vii. The Bootloader will automaticly restart.

## 4.2.8 Maintenance

**NOTE:**

This screen applies to both Benchmark Boilers and Innovation Water Heaters.

Innovation Water Heaters and Benchmark Boilers require routine maintenance to ensure reliability and efficiency. There are two maintenance cycles: 12 month and 24 months. The Edge Controller keeps track of both cycles and displays a warning when either cycle is ending, prompting the maintenance technician to perform the required maintenance.

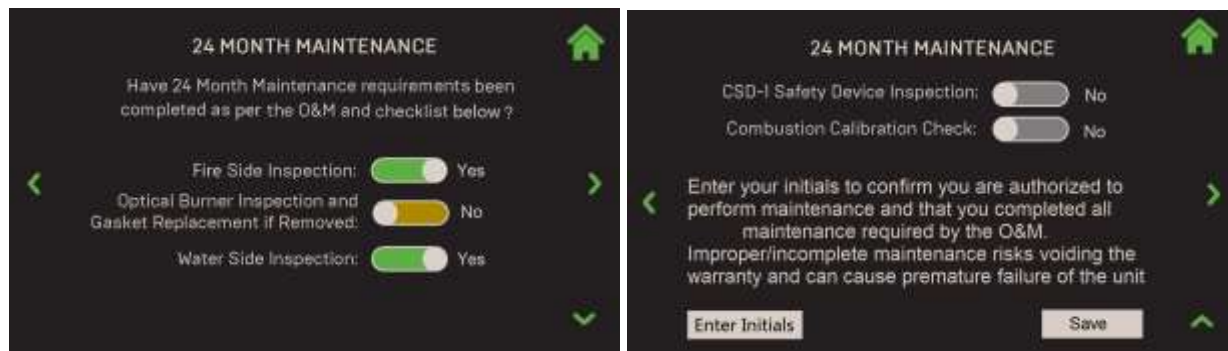
The maintenance technician must confirm that maintenance has been fully or partially completed by using the **12** and **24 Month Maintenance** screens.



1. Go to: **Main Menu → Advanced Setup → Unit → Maintenance.**



**Figure 4.2.8-1: Unit: 12 Month Maintenance Screen**



**Figure 4.2.8-2: Unit: 24 Month Maintenance Screen**

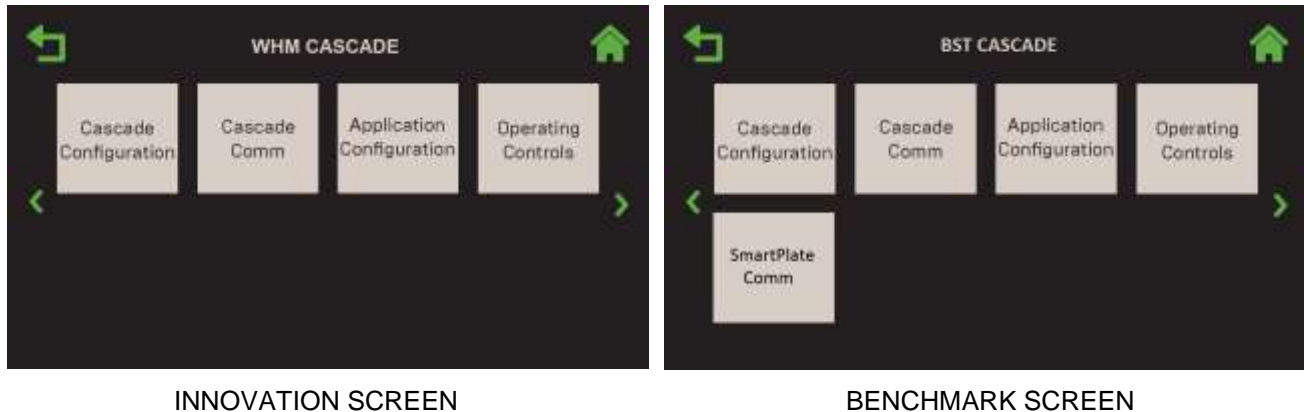
2. Either the **12 Month Maintenance** or **24 Month Maintenance** screen appears, depending on which cycle is coming up next. On a new unit, the 12 Month screen appear first.
3. In the **12 Month Maintenance** screen, once all 12 month maintenance tasks have been completed set the toggle to **Yes**, enter your initials in the lower-left field, then press **Save**. The Edge Controller will reset the 12 Month Maintenance cycle.
4. In the **24 Month Maintenance** screen, set each of the 24 month maintenance tasks that have been completed to **Yes**, then enter your initials in the lower-left field.
5. When all tasks have been completed, press **Complete** (the **Complete** button doesn't appear until all tasks have been completed). However, if any task is still set to **No**, you can press **Save** to close this screen; the 24 Month calendar is **not** reset.
6. Return to this screen once all tasks have been completed.
7. Once all 24 month maintenance tasks have been completed, set all toggles to **Yes**, then press **Complete**. The 24 Month Maintenance cycle is reset.



## 4.3 WHM & BST Cascade

The **BST Cascade** and **WHM Cascade** screens provide options to alter system settings that control the BST Cascade or WHM Cascade.

1. Go to: **Main Menu → Advanced Setup → WHM Cascade or BST Cascade.**



**Figure 4.3: Advanced Setup: WHM & BST Cascade Screens**

2. All the options on this screen are greyed out (disabled) except **Cascade Configuration** until WHM Cascade or BST Cascade functionality has been enabled, as described below.

**NOTE:**

Once BST or WHM Cascade functionality is enabled, you can navigate from one **Cascade** screen to the next in round-robin fashion using the **Page Left** and **Page Right** icons.

### 4.3.1 Cascade Configuration

Water Heater Management (WHM) and BST (Boiler Sequencing Technology) functionality are enabled from this screen. To enable WHM, see the next [Section 4.3.1.1](#). To enable BST, see [Section 4.3.1.2](#).

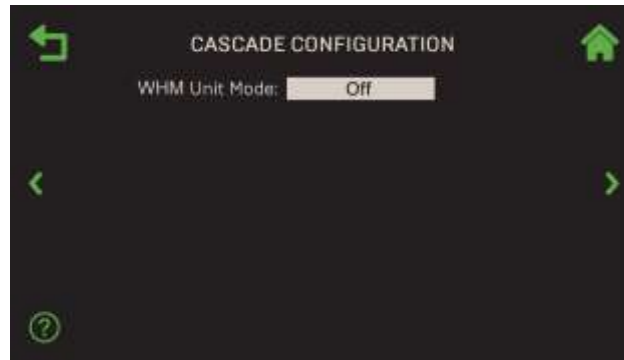
#### 4.3.1.1 Cascade Configuration – Innovation

Water Heater Management (WHM) functionality is enabled from this screen by setting **WHM Unit Mode** to either **WHM Manager** or **WHM Client** (default = **Off**). Once enabled, the following occurs:

- Additional WHM parameters appear on the screen. The specific parameters depend on whether **WHM Manager** or **WHM Client** was selected.
- If the unit is configured as a **WHM Manager**:
  - All parameters below (and in all other sections under WHM Cascade, below) apply to all units in the WHM cascade and will take precedence over the same parameters on units configured as **WHM Clients**.
  - The unit **Application Configuration** screen for standalone units (in [Section 4.2.6.1: Unit Application Configuration](#)) is disabled.

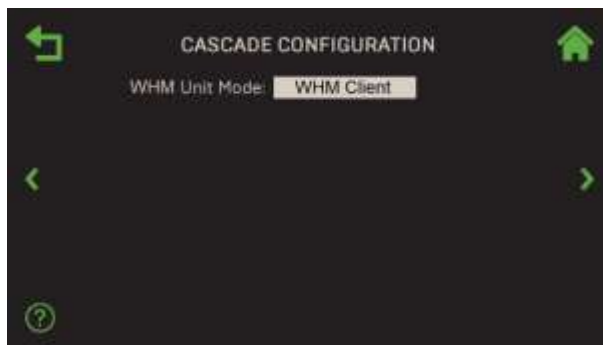
## SECTION 4 – ADVANCED SETUP

- Go to: **Main Menu → Advanced Setup → WHM Cascade → Cascade Configuration.**

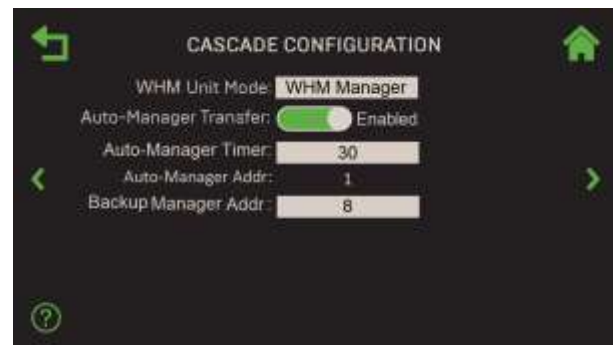


**Figure 4.3.1.1-1: WHM Cascade: Cascade Configuration Screen**

- If the unit is designated as the WHM Manager, choose **WHM Manager** in the **WHM Unit Mode** parameter. Choose **WHM Client** on all other units in the Cascade.



WHM Unit Mode = WHM Client



WHM Unit Mode = WHM Manager

**Figure 4.3.1.1-2: WHM Cascade: Cascade Configuration**

- If you chose **WHM Manager**, the following additional parameters appear:
  - **Auto-Manager Transfer:** If enabled, WHM Manager functionality can be transferred to a designated Backup Manager. The Backup Manager must be connected to all system level sensors, either via dual lead sensors or via Modbus wiring. When enabled, the following additional parameters appear:
    - **Auto-Manager Timer:** Specifies the time before switching over Manager functionality. (Range: 10 to 120 seconds, Default = 15)
    - **Auto-Manager Addr:** Read-Only display of the WHM Manager's address.
    - **Backup Manager Addr:** Enter the address of the unit you want to designate as the Backup Manager. It can be any address between **0** and **16** except the value of **Auto- Manager Addr**. (Range: 0 to 16)

**4.3.1.2 Cascade Configuration – Benchmark**

BST (Boiler Sequencing Technology) functionality is enabled from this screen by setting **Unit Mode** to either **BST Manager** or **BST Client** (default = **Off**). Once enabled, the following occurs:

- Additional BST parameters appear on the screen. The specific parameters depend on whether **BST Manager** or **BST Client** was selected.
- If the unit is configured as a **BST Manager**:
  - All parameters below (and in all other sections under BST Cascade) apply to all units in the BST cascade, and will take precedence over the same parameters on units configured as **BST Clients**.
  - The unit **Application Configuration** screen for standalone units (in [Section 4.2.6.2: Unit Application Configuration](#)) is disabled.

1. Go to: **Main Menu → Advanced Setup → BST Cascade → Cascade Configuration**.



**Figure 4.3.1.2-1: BST Cascade: Cascade Configuration Screen**

2. If the unit is designated as the BST Manager, choose **BST Manager** in the **Unit Mode** parameter. Choose **BST Client** on all other units in the Cascade.



Unit Mode = BST Client



Unit Mode = BST Manager

**Figure 4.3.1.2-2: BST Cascade: Cascade Configuration**

3. The following parameters appear on both **BST Client** and **BST Manager** units:

- **Auto-Manager Transfer:** If enabled, BST Manager functionality can be transferred to a designated Backup Manager. The Backup Manager must be connected to all system level sensors, either via dual lead sensors or via Modbus wiring. When enabled, the following additional parameters appear:

- **Auto-Manager Timer:** Specifies the time before switching over Manager functionality. (Range: 10 to 120 seconds, Default = 30)
- **Auto-Manager Addr:** A read-only display of the BST Manager's address.
- **Backup Manager Addr:** Enter the address of the unit you want to designate as the Backup Manager. It can be any address above **0** except the value of **Auto-Manager Addr**. (Range: 0 to 16)
- **Hdr Temp Sensor:** If plant operation is based on feedback from the Header Temp Sensor, choose how to communicate with the sensor:
  - **Network:** Choose this option if the Header Temp Sensor is wired to the Modbus transmitter. If chosen, the following additional parameter appears:
    - **SH Hdr Temp Point:** The Modbus point within the Modbus address of the Header Temp Sensor (Range: 0 to 255, default = 14).
    - **SH Sensor Comm Addr:** Specifies the Modbus transmitter address, common to all Modbus sensors. (Range: 0 to 255, default = 240)
  - **FFWD Temp:** Choose this option only if **Control Type = C-More** (in [Section 4.2.1: Unit Settings](#)); FFWD is the direct connect option in the C-More.
  - **Direct:** Choose this option if the Modbus transmitter is connected directly to the unit.
  - **BAS:** Choose this option if header temperature is received from the site's Building Automation System.
  - **OFF:** Disables header temperature sensor feedback functionality.
- **Rtn Hdr Temp Sensor:** If plant operation includes feedback from the Return Header Temp Sensor, choose how to communicate with the sensor:
  - **Network:** Choose this option if the Return Header Temp Sensor is wired to the Modbus transmitter. If chosen, the following additional parameter appears:
    - **Rtn Hdr Sens Point:** The Modbus point within the Modbus address of the Header Temp Sensor (Range: 0 to 255, default = 16).
  - **FFWD Temp:** Choose this option only if **Control Type = C-More** in [Section 4.2.1: Unit Settings](#)); FFWD is the direct connect option in the C-More.
  - **Direct:** Choose this option if the Modbus transmitter is connected directly to the unit.
  - **BAS:** Choose this option if header temperature is received from the site's Building Automation System.
  - **OFF:** Disables header temperature sensor feedback functionality.
- **Outdoor Air Temp Sens:** Choose how to communicate with this sensor:
  - **Off:** Disables Outdoor Air Temp Sensor functionality.
  - **Direct:** Choose this option if the analog Outdoor Air Temp Sensor is connected directly to the unit.
  - **BAS:** Choose this option if outside temperature is received from the site's Building Automation System.
  - **Network:** Choose this option if the Outdoor Air Temp Sensor is wired to the Modbus transmitter. If chosen, the following additional parameters appear:
    - **BST Outdoor Temp:** A read-only display indicating how the unit communicates with the Outdoor Air Temp Sensor.

- **Warm Weather Shutdown:** The threshold outside temperature above which the unit shuts down. (Range: 30°F to 120°F)
- **Outdoor Temp Addr:** Specifies the Modbus transmitter address (common to all Modbus sensors). (Range: 0 to 255, default = 240)
- **OAT Temp Point:** The Modbus point within the Modbus address of the Outside Air Temp Sensor (Range: 0 to 255, default = 15).

### 4.3.2 Cascade Communication

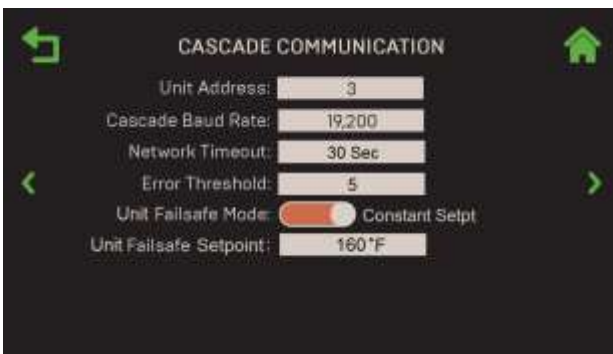
The **Cascade Communication** screen allows you to modify individual communication parameters. For Innovation units, see the next [Section 4.3.2.1](#). For Benchmark units, see [Section 4.3.2.2](#).

#### 4.3.2.1 Cascade Communication – Innovation

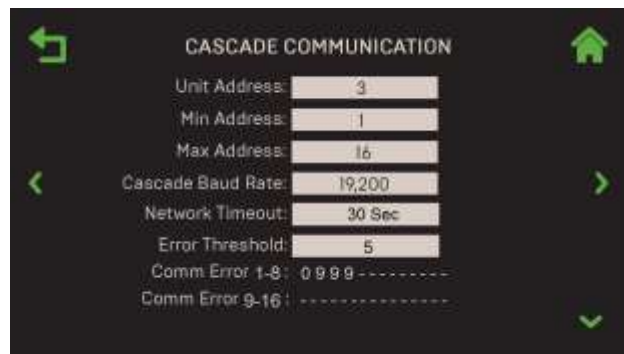
**NOTES:**

This screen is available only after WHM functionality has been enabled (see the **WHM Unit Mode** parameter in [Section 4.3.1.1: Cascade Configuration – Innovation](#)). If the unit is configured as a **WHM Manager**, its parameters apply to this and all **WHM Client** units.

1. Go to: **Main Menu → Advanced Setup → WHM Cascade → Cascade Comm.**



WHM CLIENT SCREEN



WHM MANAGER SCREEN

**Figure 4.3.2.1: WHM Cascade: Cascade Communication Screens**

2. Configure the following parameters on both **WHM Client** and **WHM Manager** screens:

- **Unit Address:** The unit’s address in the WHM Cascade network. (Range: 1 to 16)

- **Cascade Baud Rate:** Select the rate at which information is transferred in a communication channel: **9600, 19200, 38400, 115200** bits per second.
  - **Network Timeout:** The timeout value before a Modbus Fault is declared due to no response from the WHM Manager unit or from the BAS. (Range: 5 to 999)
  - **Error Threshold:** The number of Modbus Comm errors allowed before invoking a Modbus Comm Fault. (Range: 1 to 9)
  - **Unit Failsafe Mode:** Specifies the unit's operating mode if there is a loss of communication with BAS or external sensor (i.e., an outdoor temperature sensor), either **Constant** or **Shutdown**. If the loss of communication is to the WHM Manager unit, this setting applies to the entire plant. If set to **Constant Setpt**, the following additional parameter appears:
    - **Unit Failsafe Setpoint:** Specifies the plant's setpoint if there is a loss of communication with BAS or header sensor. (Range: 60°F to 150°F)
3. On unit designated as a **WHM Manager**, the following additional parameters appear:
- **Min & Max Addresses:** The address range of the units in the WHM cascade. (Range: 1 to 16)
  - **Comm Error 1-8, 9-16:** Displays the number of Comm errors on Comm ports 1 through 8 (9 through 16). If no valid address is entered for a client unit, it displays “-” for that address. The maximum number of error counts is 9.
  - **SSD Address:** The Client/Client Device address (for backwards compatibility).
  - **SSD Temp Format:** Choose either **Points** or **Degrees**.
  - **Time & Date Sync:** If Enabled, all Client units in the Cascade will synchronize time and date with the WHM Manager.
  - **WHM Min Units:** The minimum number of units in the WHM cascade. (Range: 1 to 16)
  - **WHM Max Units:** The maximum number of units in the WHM cascade. (Range: 1 to 16)
  - **WHM On Timeout:** Specifies the time the WHM Manager must wait for a backup Client unit to turn on. (Range: 15 to 300)

#### 4.3.2.2 Cascade Communication – Benchmark

**NOTES:**

This screen is available only after BST functionality has been enabled (see the **Unit Mode** parameter in [Section 4.3.1.2: Cascade Configuration – Benchmark](#)). If the unit is configured as a **BST Manager**, its parameters apply to this and all **BST Client** units.

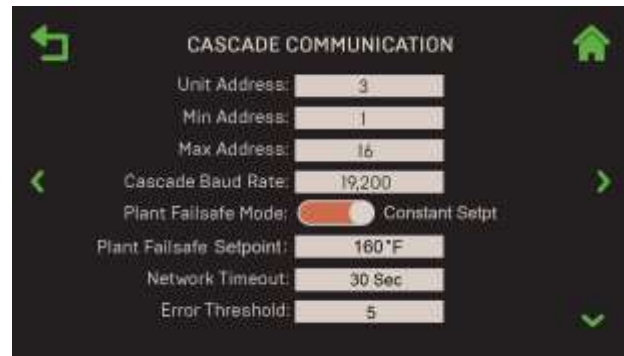
1. Go to: **Main Menu → Advanced Setup → BST Cascade → Cascade Comm**.



## SECTION 4 – ADVANCED SETUP



BST CLIENT SCREEN



BST MANAGER SCREENS

**Figure 4.3.2.2: BMK Cascade: Cascade Communication Screens**

2. Configure the following parameters on both **BST Client** and **BST Manager** screens:
  - **Unit Address:** The unit's address in the WHM Cascade network. (Range: 1 to 16)
  - **Cascade Baud Rate:** Select the rate at which information is transferred in a communication channel: **9600, 19200, 38400, 115200** bits per second.
  - **Network Timeout:** The timeout value before a Modbus Fault is declared due to no response from the WHM Manager unit or (if a Manager) from the BAS. (Range: 5 to 999)
  - **Plant Failsafe Mode:** Specifies what happens if there is a loss of communication with BAS or between the BST Manager and BST Client units. On the WHM Manager unit, this setting applies to the all units in the Cascade. Choose either **Constant** or **Shutdown**. If set to **Constant Setpt**, the following additional parameter appears:
    - **Plant Failsafe Setpoint:** Specifies the plant's setpoint if there is a loss of communication with BAS or header sensor.
  - **Error Threshold:** The number of Modbus Comm errors allowed before invoking a Modbus Comm Fault. (Range: 1 to 9)
3. If the unit is configured as a **BST Manager**, the following additional parameters appear:
  - **Min & Max Addresses:** The address range of the units in the BST cascade. (Range: 1 to 16)
  - **Comm Error 1-8, 9-16:** Displays the number of Comm errors on Comm ports 1 through 8 (9 through 16). If no valid address is entered for a client unit, it displays "-" for that address. The maximum number of error counts is 9.
  - **SSD Address:** The Client/Client Device address (for backwards compatibility).
  - **SSD Temp Format:** Choose either **Points** or **Degrees**.

- **Time&Date Sync over BST:** If enabled, the BST Manager's time and date are sent to all BST Clients units; all units in the cascade will then be synchronized.

### 4.3.3 WHM and BST Application Configuration

**Application Configuration** screen allows you to configure individual operating parameters that will be transmitted to all WHM or BST Client units. For Innovation units, see the next [Section, 4.3.3.1](#). For Benchmark units, see [Section 4.3.3.2](#).

#### 4.3.3.1 WHM Application Configuration – Innovation

**NOTES:**

- This screen is available only after WHM Cascade functionality has been enabled (see the **WHM Unit Mode** parameter in [Section 4.3.1.1: Cascade Configuration – Innovation](#)).
- If the unit is configured as a **WHM Manager**, the parameters in this screen apply to this unit and will be transmitted to all WHM Client units. If the unit is configured as a **WHM Client**, the parameters configured on the **WHM Manager** will take precedence.
- Once WHM Cascade functionality is enabled on a unit, the [Unit → Application Configuration – Innovation screen in Section 4.2.6.1](#) (above) is disabled.

1. Go to: **Main Menu → Advanced Setup → WHM Cascade → Application Configuration**. Note, the only Application currently available is **DHW**.



**Figure 4.3.3.1: WHM Cascade: Application Configuration Screen**

2. In the **WHM Setpoint** parameter specify the setpoint for the unit or the Cascade (if the unit is a WHM Manager). (Range: 60°F to 170°F)

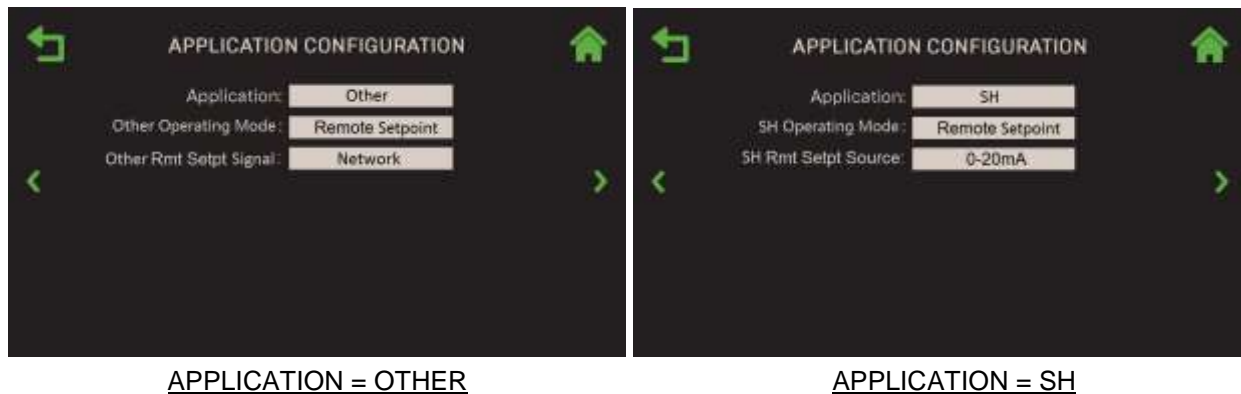


### 4.3.3.2 BST Application Configuration – Benchmark

#### NOTES:

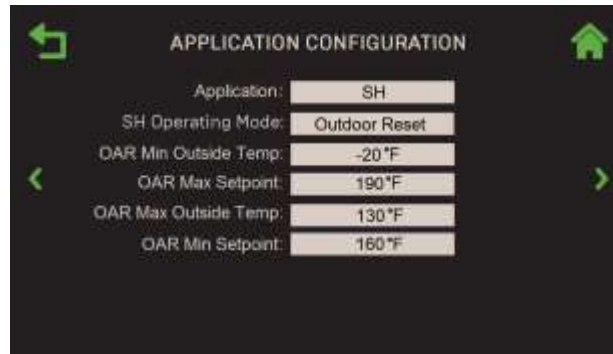
- This screen is available only after BST Cascade functionality has been enabled (see the **Unit Mode** parameter in [Section 4.3.1.2: Cascade Configuration – Benchmark](#)).
- If the unit is configured as a **BST Manager**, the parameters in this screen apply to this unit and will be transmitted to all BST Client units. If the unit is configured as a **BST Client**, the parameters configured on the **BST Manager** will take precedence.
- Once BST Cascade functionality is enabled on a unit, the [Unit → Application Configuration – Benchmark screen \(Section 4.2.6.2, above\)](#) is disabled.

1. Go to: **Main Menu → Advanced Setup → BST Cascade → Application Configuration**.
2. Choose the **Application: SH** (Space Heating) or **Other**.



**Figure 4.3.3.2-1: BST Cascade: Application Configuration – Example 1<sup>st</sup> Screens**

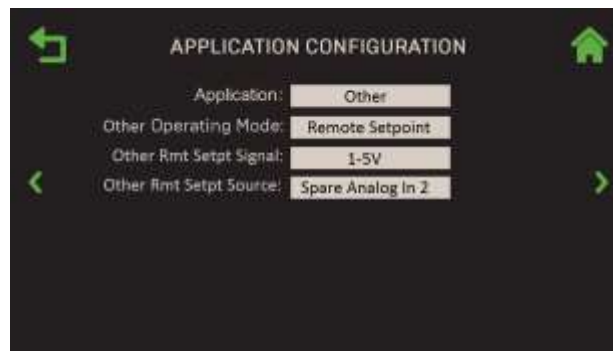
3. If you chose **SH** in step 2:
  - Choose the **SH Operating Mode**, either **Constant Setpoint**, **Remote Setpoint** or **Outdoor Air Reset**.
    - If you chose **Constant Setpoint**, specify the setpoint in **SH Setpoint**.
    - If you chose **Remote Setpoint**, choose the source of the setpoint in **Rmt Setpt Source**:
      - 4-20mA
      - 1-5V
      - Network
      - 0-20mA
      - 0-5V
      - BAS
    - If you chose **Outdoor Air Reset**, configure the four **OAR Min** and **OAR Max** parameters. These four parameters are used to create the associated OATR curve. Once the curve has been setup, the Edge Controller will compute the setpoint based on outside temperature.



**Figure 4.3.3.2-2: BST Cascade: Application Configuration, Application = SH**

4. If you chose **Other** in step 2:

- Choose the **Other Operating Mode**, either **Constant Setpoint** or **Remote Setpoint**.
  - If you chose **Constant Setpoint**, specify the setpoint in **Other Setpoint**.
  - If you chose **Remote Setpoint**:
    - Choose the source of the setpoint in **Other Rmt Setpt Signal**:
      - 1-5V
      - 0-5V
      - Network
    - Choose the source of the setpoint in **Rmt Setpt Source**:
      - Spare Analog In 1
      - Spare Analog In 2
      - Spare Analog In 3



**Figure 4.3.3.2-4: BST Cascade: Application Configuration, Application = Other**

## 4.3.4 Operating Controls

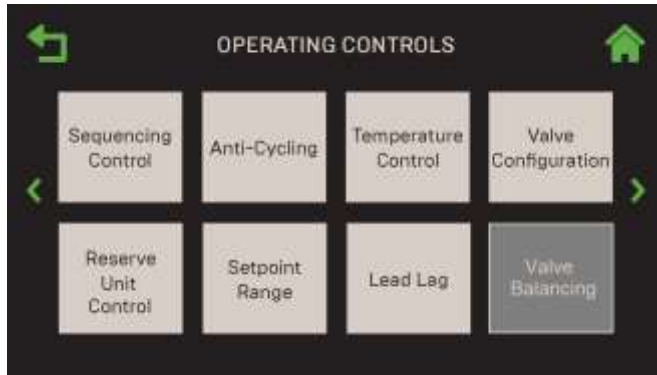
The **Operating Controls** screen provides access to multiple operating parameters for the plant and units in a BST or WHM Cascade.

### NOTE:

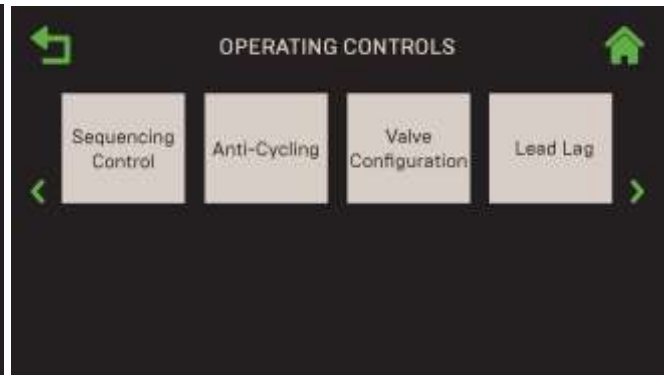
This screen (and all the screens accessible from this screen) is available only after WHM or BST Cascade functionality has been enabled (see the **WHM Unit Mode** parameter in [Section 4.3.1.1: Cascade Configuration – Innovation](#), or the **Unit Mode** parameter in [Section 4.3.1.2: Cascade Configuration – Benchmark](#)). If the unit is configured as a **BST** or **WHM Manager**, the parameters apply to this unit and all BST or WHM Client units.

SECTION 4 – ADVANCED SETUP

1. Go to: **Main Menu → Advanced Setup → WHM Cascade → Operating Controls** (Innovation), or **Main Menu → Advanced Setup → BST Cascade → Operating Controls** (Benchmark).



BENCHMARK SCREEN



INNOVATION SCREEN

**Figure 4.3.4: WHM & BST Cascade: Operating Controls Screen**

**4.3.4.1 Sequencing Controls**

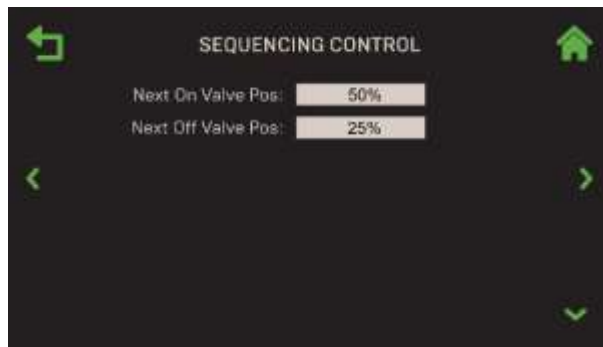
The **Sequencing Controls** screens offers options related to sequencing of units in the plant. For Innovation units, see the next [Section, 4.3.4.1.1](#). For Benchmark units, see [Section 4.3.4.1.2](#).

**4.3.4.1.1 Sequencing Controls – Innovation**

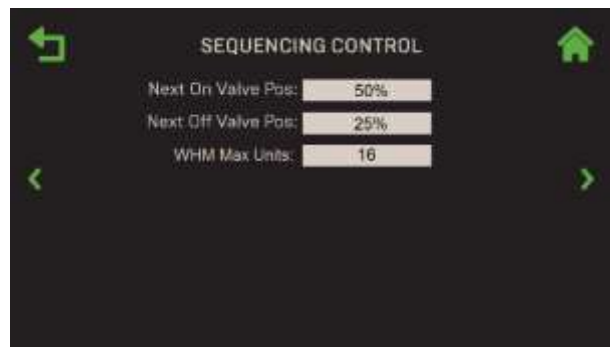
**NOTES:**

- This screen is available only after WHM Cascade functionality has been enabled (see the **WHM Unit Mode** parameter in [Section 4.3.1.1: Cascade Configuration](#)).
- If the unit is configured as a **WHM Manager**, the parameters apply to this unit and all WHM Client units. If the unit is configured as a **WHM Client**, the parameters configured on the **WHM Manager** will take precedence.

1. Go to: **Main Menu → Advanced Setup → WHM Cascade → Operating Controls → Sequencing Control**. The parameters that appear on this screen depend on whether the unit is configured as a **WHM Manager** or **WHM Client** in [Section 4.3.1.1: Cascade Configuration – Innovation](#).



WHM Client screen



WHM Manager screen

**Figure 4.3.4.1.1: Operating Controls: Sequencing Controls Screen**

## SECTION 4 – ADVANCED SETUP

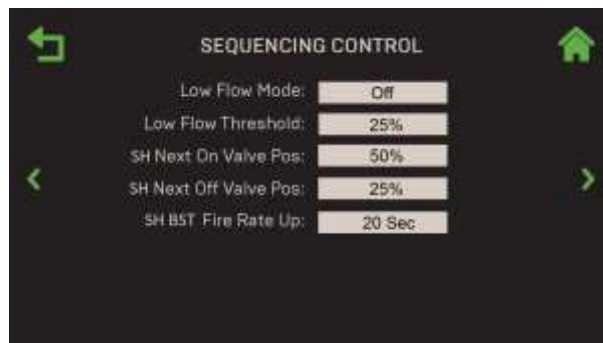
2. The following parameters are available on both WHM Manager and WHM Client units.
  - **Next On Valve Pos:** Determines the valve position that triggers the next unit to come on line. (Range: 16% to 100%)
  - **Next Off Valve Pos:** Determines the valve position that triggers the next unit to come off line. (Range: 16% to 100%)
3. The following parameters appear only when the unit is configured as a **WHM Manager**:
  - **WHM Max Units:** The maximum number of units that will fire. For example, if there are 5 units, but this setting is set to 3, the plant will not fire more than 3 units. (Range: 1 to 16)

## 4.3.4.1.2 Sequencing Controls – Benchmark

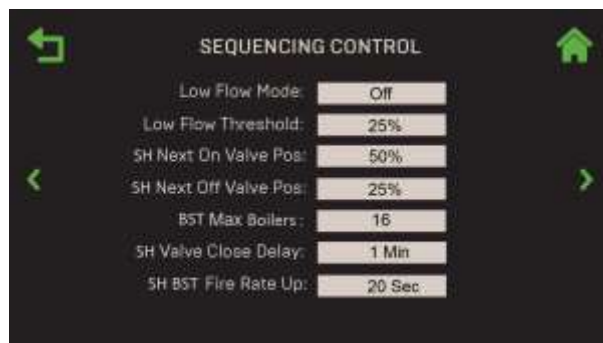
**NOTES:**

- This screen is available only after BST Cascade functionality has been enabled (see the **Unit Mode** parameter in [Section 4.3.1.2: Cascade Configuration – Benchmark](#)).
- If the unit is configured as a **BST Manager**, the parameters apply to this unit and all BST Client units. If the unit is configured as a **BST Client**, the parameters configured on the **BST Manager** will take precedence.

1. Go to: **Main Menu → Advanced Setup → BST Cascade → Operating Controls → Sequencing Control**. The parameters that appear on this screen depend on whether the unit is configured as a **BST Manager** or **BST Client** in [Section 4.3.1.2: Cascade Configuration – Benchmark](#).



BST Client screen



BST Manager screen

**Figure 4.3.4.1.2: Operating Controls: Sequencing Controls Screen**

2. The following parameters are available on both BST Manager and BST Client units.
  - **Low Flow Mode:** Choose **Off**, **On - Outlet Temp** or **On - Avg Temp**. If either “On” option is chosen, BST monitors the multi-unit system to detect if a “low-flow” condition exists. If it does exist, BST slowly shuts down one unit at a time in an attempt to raise the Fire Rate of the remaining units. If the low-flow condition persists, and only a single unit remains ignited, BST will use the “Outlet Temperature Sensor” of the remaining ignited unit to control the temperature. The Outlet Temperature Sensor is mounted in the individual unit and drastically increases the response time to precisely control temperature.

- **Low Flow Threshold:** For low flow applications, this parameter allows the unit to operate without excessive cycling. This parameter specifies the valve position below which the unit plant will enter this mode (Range: 10% to 35%, default = 25%).
  - **SH Next On Valve Pos:** Determines the valve position that triggers the next unit to come on line. (Range: 16% to 100%)
  - **SH Next Off Valve Pos:** Determines the valve position that triggers the next unit to come off line. (Range: 16% to 100%)
  - **SH BST Fire Rate Up:** Controls the frequency of updates made to the Fire Rate sent to all units. This feature can be used to slow down the rate of change of the Fire Rate of the BST System. (Range: 1 to 120 sec.)
3. The following parameters appear only when the unit is configured as a BST Manager:
- **BST Max Boilers:** The maximum number of units that will fire. For example: if there are 5 units, but this setting is set to 3, the plant will not fire more than 3 units. (Range: 1 to 16)
  - **SH Valve Close Delay:** The time an open Isolation Valve will remain open once a unit has cycled off. When an ignited unit is cycled off, its Isolation Valve will remain open for the specified time to dissipate residual heat. (Range: 0 to 15)

#### 4.3.4.2 Anti-Cycling Control

The parameters in the **Anti-Cycling Control** screen are used to prevent unwanted cycling. This screen applies to both Benchmark Boilers and Innovation Water Heaters.

- For Innovation units, see the next [Section, 4.3.4.1.1](#).
- For Benchmark units, see [Section 4.3.4.1.2](#).

##### 4.3.4.2.1 Anti-Cycling Control – Innovation

**NOTE:**

- This screen is available only after WHM Cascade functionality has been enabled (see the **WHM Unit Mode** parameter in [Section 4.3.1: Cascade Configuration](#)).
- If the unit is configured as a **WHM Manager**, the parameters apply to this unit and all WHM Client units.

## SECTION 4 – ADVANCED SETUP

- Go to: **Main Menu → Advanced Setup → WHM Cascade → Operating Controls → Anti-Cycling Controls.**



**Figure 4.3.4.2: Operating Controls: Anti-Cycling Control Screen – Innovation**

- The following parameters are available:
  - On Delay:** Minimum length of time a unit must stay off after shutting down or going into standby. (Range: 30 to 300 sec.)
  - WHM Off Delay:** Specifies the amount of time the full shut down will be delayed. (Range: 30 to 300 sec.)
  - Shutoff Delay Temp:** Specifies the temperature above setpoint the unit may rise to during delay shutdown. (Range: 0°F to 25°F)

#### 4.3.4.2.2 Anti-Cycling Control – Benchmark

**NOTE:**

- This screen is available only after BST Cascade functionality has been enabled (see the **Unit Mode** parameter in [Section 4.3.1.2: Cascade Configuration – Benchmark](#)). If the unit is configured as a **BST**, the parameters apply to this unit and all BST Client units.
- If the unit is configured as a **BST Manager**, the parameters apply to this unit and all BST Client units.

- Go to: **Main Menu → Advanced Setup → BST Cascade → Operating Controls → Anti-Cycling Controls.**



**Figure 4.3.4.2: Operating Controls: Anti-Cycling Control Screen – Benchmark**



2. The following parameters are available:

- **On Delay:** Minimum length of time a unit must stay off after shutting down or going into standby. (Range: 30 to 300 sec.)
- **Slow Shutdown:** Enable/Disable the Slow Shutdown feature. Once enabled on a unit, if the unit is run at a fire rate above **Off Delay Threshold** and then shut down, the fire rate will be reduced to the Stop Level for a period of time defined in **Off Delay**. This feature prevents units running at high fire rates from being quickly turned off and flushed with cold water, thereby possibly damaging the heat exchanger. Once enabled, the following additional parameters appear:
  - **Off Delay:** Specifies the amount of time the full shut down will be delayed when **Slow Shutdown** is enabled. (Range: 0 to 9999 sec.)
  - **Off Delay Threshold:** The threshold fire rate above which the **Slow Shutdown** feature will take effect. (Range: 40 to 100%)
- **Shutoff Delay Temp:** Specifies the temperature above setpoint the unit may rise to during delay shutdown. (Range: 0°F to 25°F)
- **Demand Offset:** Offset temperature from setpoint before a unit may come online. (Range: 0°F to 25°F)

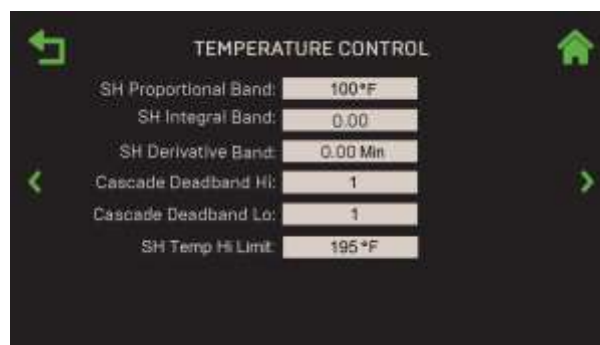
#### 4.3.4.3 Temperature Control – Benchmark Only

The **Temperature Control** screen provides parameters that can be used to fine-tune the temperature responsiveness and limitations under which the plant operates.

**NOTE:**

- This screen applies only to Benchmark Boilers.
- This screen is available only after BST Cascade functionality has been enabled (see the **Unit Mode** parameter in [Section 4.3.1.2: Cascade Configuration – Benchmark](#)). If the unit is configured as a **BST Manager**, the parameters apply to this unit and all BST Client units.

1. Go to: [Main Menu](#) → [Advanced Setup](#) → [BST Cascade](#) → [Operating Controls](#) → [Temperature Control](#).



**Figure 4.3.4.3 Operating Controls: Cascade Temperature Control Screen**

2. The following parameters appear.

## SECTION 4 – ADVANCED SETUP

- **SH Proportional Band:** Generates a fire rate based on the error that exists between the setpoint temperature and the actual outlet temperature. If the difference is less than the value of these parameters, the fire rate will be less than 100%. If the error is equal to or greater than the value of these parameters, the fire rate will be 100%. (Range: 1°F to 120°F)
- **SH Integral Band:** Specifies the fraction of the output, due to setpoint error, to add or subtract from the output each minute to move towards the setpoint. (Range: 0.00 to 2.00)
- **SH Derivative Band:** This value responds to the rate of change of the setpoint error. This is the time that this action advances the output. (Range: 0.0 to 2.0 min.)
- **Cascade Deadband Hi & Lo:** These parameters define a temperature range within which the plant outlet temperature can drift above and below the Setpoint. (Range: 0 to 25°F)
- **SH/Other Temp Hi Limit:** The highest temperature the plant will meet for the chosen Application. (Range: 40 to 210°F)

#### 4.3.4.4 Valve Configuration

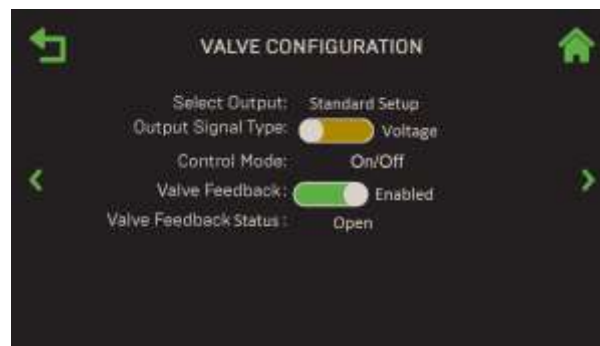
The Valve Configuration screen contains parameters necessary for communicating with and controlling the external sequencing valves on the units in a BST or WHM Cascade. For Innovation units, see the next [Section, 4.3.4.4.1](#). For Benchmark units, see [Section 4.3.4.4.2](#).

##### 4.3.4.4.1 Valve Configuration – Innovation

**NOTE:**

- This screen is available only after WHM Cascade functionality has been enabled (see the **WHM Unit Mode** parameter in [Section 4.3.1.1: Cascade Configuration – Innovation](#)).
- If the unit is configured as a **WHM Manager**, the parameters apply to this unit and all WHM Client units.

1. Go to: **Main Menu → Advanced Setup → WHM Cascade → Operating Controls → Valve Configuration.**



**Figure 4.3.4.4.1: Operating Controls: Valve Configuration Screen – Innovation**

2. Configure the following parameters:
  - **Output Signal Type:** Select the output signal type of the selected output: **Current** or **Voltage**.



## SECTION 4 – ADVANCED SETUP

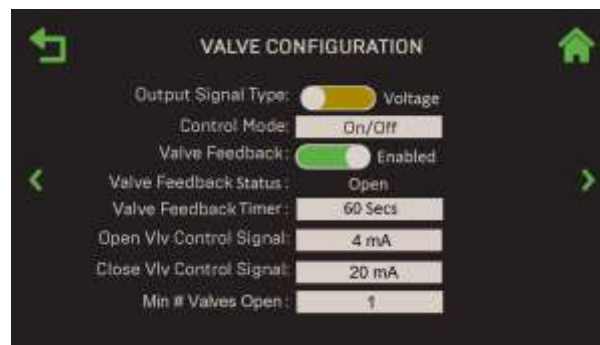
- **Control Mode:** A read-only display of the current Control Mode: **On/Off**.
- **Valve Feedback:** Choose **Enabled** or **Disabled**. If Enabled, the following additional parameters appear:
  - **Valve Feedback Timer:** The amount of time for the valve to open before returning an error. (Range 30 to 240 sec.)
  - **Valve Feedback Status:** A read-only display of the current valve status.

## 4.3.4.4.2 Valve Configuration – Benchmark

**NOTE:**

- This screen is available only after BST Cascade functionality has been enabled (see **Unit Mode** parameter in [Section 4.3.1.2: Cascade Configuration – Benchmark](#)).
- If the unit is configured as a **BST Manager**, the parameters apply to this unit and all BST Client units.

1. Go to: **Main Menu → Advanced Setup → BST Cascade → Operating Controls → Valve Configuration**.



**Figure 4.3.4.4.2: Operating Controls: Valve Configuration Screen – Benchmark**

2. In the **Output Signal Type** field, choose either **Current** or **Voltage**.
3. Configure the following parameters:
  - **Control Mode:** Choose one: **On/Off**, **Linear Modulation** or **Delta T Modulation**.
  - **Valve Feedback:** Choose **Enabled** or **Disabled**. If Enabled, the following additional parameters appear:
    - **Valve Feedback Status:** A read-only display of the current valve status.
    - **Valve Feedback Timer:** The time to detect the **Valve Feedback Status** (Range: 30 to 240 sec.).
  - **Open Vlv Control Signal:** Select the signal that will “open” the valve: **0 mA**, **4 mA** or **20 mA**.
  - **Close Vlv Control Signal:** Select the signal that will “close” the valve: **0 mA**, **4 mA** or **20 mA**.
  - **Min # Valves Open:** Specify the minimum number of valves that must remain open at all times. (Range: 1 to 16)

### 4.3.4.5 Setpoint Range – Benchmark Only

The **Setpoint Range** screen includes all Setpoint Limiting and Setpoint Setback parameters.

#### NOTES:

- This screen applies only to Benchmark Boilers.
- This screen is available only after BST Cascade functionality has been enabled (see the **Unit Mode** parameter in [Section 4.3.1.2: Cascade Configuration – Benchmark](#)). If the unit is configured as a **BST Manager**, the parameters apply to this unit and all BST Client units.
- Some of the parameters below also appear in [Section 4.6.1.3: Setpoint Range](#), which is available on standalone units.

1. Go to: **Main Menu → Advanced Setup → BST Cascade → Operating Controls → Setpoint Range**.



**Figure 4.3.4.5: Operating Controls: Setpoint Range Screen**

2. Depending on the Application chosen in either the **Unit Application** screen ([Section 4.2.6.2: Unit Application Configuration – Benchmark](#)) or the **BST Application Configuration** screen ([Section 4.3.3.2: BST Application Configuration – Benchmark](#)) configure the following parameters, which together determine the temperature range within which the setpoint can vary:
  - **SH Setpt Low Limit** (Application = SH, Range: 40°F to 245°F)
  - **SH Setpt High Limit** (Application = SH, Range: 20°F to 220°F)
  - **Other Setpt Low Limit** (Application = Other, Range: 20°F to 245°F)
  - **Other Setpt High Limit** (Application = Other, Range: 20°F to 245°F)
3. Set the **Setpoint Limiting** parameter to **Enabled** to **Disabled**. If **Enabled**, this feature acts as a temperature limiting governor. Should a unit's outlet temperature equal **Setpoint High Limit**, a PID function will intervene and maintain the outlet temperature at the **Setpoint High Limit** minus the **Setpoint Limit Band** (see below):
  - **Setpoint Limit Band**: Sets the number of degrees *below* **Setpoint High Limit** the unit's outlet temperature must fall before the unit restarts (Range = 0°F to 10°F)
4. Set the **Setpoint Schedule** parameter to **Enabled** to **Disabled**. If **Enabled**, this feature will lower the Setpoint during periods of reduced demand for heat, such as at night. If **Enabled**, the following additional parameters appear (these same three parameters also appear in [Section 4.6.1.3: Setpoint Range](#) and can be changed in either screen):

## SECTION 4 – ADVANCED SETUP

- **Setback Setpoint:** The Setpoint that will be in effect during the Setback period. (Range = 60°F to 150°F)
- **Setback Start Time:** The **Setback** period's **start** time (example: 11:00 PM).
- **Setback Stop Time:** The **Setback** period's **end** time (example: 5:00 AM).

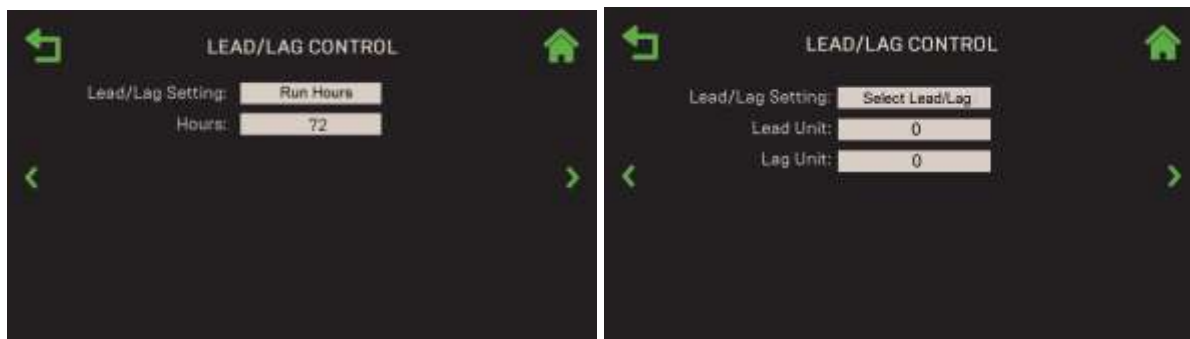
#### 4.3.4.6 Lead/Lag

The **Lead/Lag** screen allows you to create a Lead/Lag profile that the BST or WHM Cascade will follow.

**NOTE:**

- This screen applies to both Benchmark Boilers and Innovation Water Heaters.
- This screen is available only after WHM or BST Cascade functionality has been enabled (see the **WHM Unit Mode** parameter in [Section 4.3.1.1: Cascade Configuration – Innovation](#), or the **Unit Mode** parameter in [Section 4.3.1.2: Cascade Configuration – Benchmark](#)). If the unit is configured as a **BST** or **WHM Client**, the parameters configured on the **BST** or **WHM Manager** will take precedence.

1. Go to: **Main Menu → Advanced Setup → WHM Cascade → Operating Controls → Lead/Lag.**



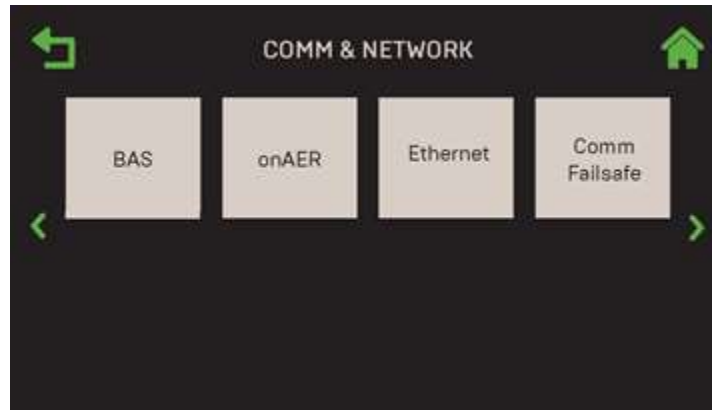
**Figure 4.3.4.7: Operating Controls: Lead/Lag Control Screen**

2. Set the **Lead/Lag Setting** to one of the following (default = **Run Hours**):
  - **Run Hours:** The **Hours** parameter appears; specify the number of hours after which the Lead unit is rotated. (Range: 25 – 225 hours)
  - **Unit Size:** Perform Lead/Lag based on unit size, starting with the smallest unit capacity.
  - **Select Lead/Lag:** The **Lead Unit** and **Lag Unit** parameters appear. Specify the address of the Lead and Lag units. (Range: 0 to 16)

## 4.4 Comm & Network

The **Comm & Network** screen allows you to configure all communication interfaces for a variety of purpose, such as BAS, onAER or smart devices. Each option is described below.

1. Go to: **Main Menu → Advanced Setup → Comm & Network**.



**Figure 4.4: Advanced Setup: Comm & Network – Innovation Shown**

**NOTE:**

You can navigate from one **Comm & Network** screen to the next in round-robin fashion using the **Page Left** and **Page Right** icons on each screen.

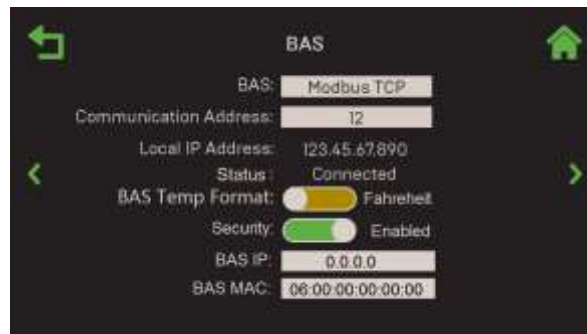
### 4.4.1 BAS (Building Automation System) – Innovation Only

The **BAS** screen provides communication parameters for the Modbus TCP interface.

**NOTE:**

This screen applies only to Innovation Water Heaters.

1. Go to: **Main Menu → Advanced Setup → Comm & Network → BAS**. The default is **Off**.
2. To enable communication with a BAS, press **BAS** and choose the **Modbus TCP** communication protocol.



**Figure 4.4.1: Comm & Network: BAS Screen**

3. The following additional parameter appear:

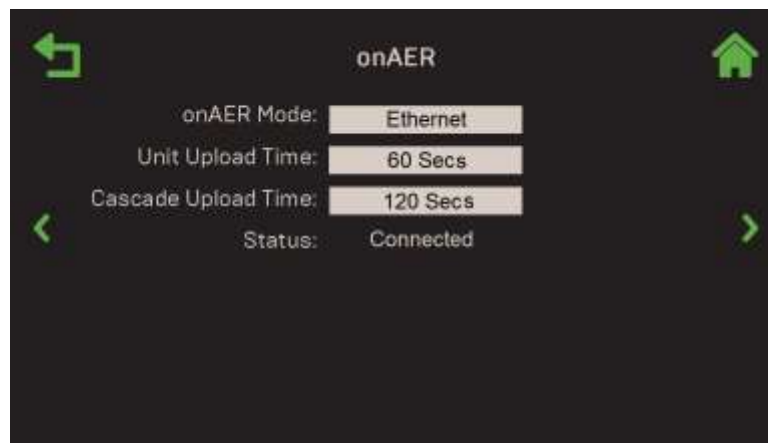
- **Communication Address:** Specify the network address of the Edge Controller on the BAS network. (Range: 0 to 127)

- **Local IP Address:** Displays the local IP address of the Edge Controller.
- **Status:** Displays the status of BAS communications.
- **BAS Temp Format:** Choose **Fahrenheit** or Celsius.
- **Security:** Choose whether to **Enable** or **Disable** BAS Security. This option prohibits communication to any devices as specified by the IP address and MAC address, per parameters below. If enabled, the following additional parameters appear:
  - **BAS IP:** Specifies the IP address of the BAS server.
  - **BAS MAC:** Specifies the MAC address of the BAS server.

#### 4.4.2 onAER

The **onAER** screen allows you to choose and configure how onAER will communicate with the network.

1. Go to: **Main Menu → Advanced Setup → Comm & Network → onAER.**



**Figure 4.4.2: Comm & Network: onAER Screen**

2. The **onAER Mode** parameter's default is **Disabled**. To enable onAER communication, choose one of the following:
  - **Ethernet:** Requires an Ethernet cable to be plugged into the Edge Controller's left side, as shown in Figure 4.2.7.1-1, in Section 4.2.7.1.
  - **Wi-Fi:** Requires the AERCO Wi-Fi module (P/N 24526-TAB) to be installed on the unit; see the *onAER Wi-Fi Module Installation Guide* (TID-0178) for instructions.
  - **Wiznet:** This option is intended for units on which the Edge Controller was installed as a replacement for the C-More Controller.
3. Once enabled, the following additional parameters appear:
  - **Unit Upload Time:** This determines how frequently unit data will upload to the server, in seconds. This will be split between unit data and cascade data (manager unit only). (Range: 30 to 9999)
  - **Cascade Upload Time:** Determines how cascade data will upload to the server, in seconds. (Range: 60 to 9999)
  - **Status:** Displays the communication interface status, which varies depending on the interface selected in Step 2.

### 4.4.3 Ethernet

The **Ethernet** screen will typically have the DHCP option **Enabled**, and therefore won't require additional configuration. If the DHCP is **Disabled**, the parameters shown below are available for editing with addresses the unit can use to communicate with the network.

**NOTE:**

Ethernet communication requires an Ethernet cable to be plugged into the Ethernet port on the Edge Controller's left side (see Figure 4.2.7.1-1 in [Section 4.2.7.2: Preparing for Firmware Update](#)).

1. Go to: **Main Menu → Advanced Setup → Comm & Network → Ethernet.**



DHCP Enabled

DHCP Disabled

**Figure 4.4.3: Comm & Network: Ethernet Screen**

2. If **DHCP** is **Disabled**, manually enter the communication parameters, typically provided by a network administrator, in the following parameters:

- **IP Address**
- **Subnet**
- **Gateway**
- **DNS 1**
- **DNS 2**

### 4.4.4 Communication Failsafe

The **Communication Failsafe** option specifies how the unit will operate when either the Manager communication or a Remote Signal is lost and the unit has to operate independently.

**NOTE:**

The parameters on this screen also appear in the **Cascade Communication** screen (see [Section 4.3.2: Cascade Communication](#)). Changing them in either one changes them in the other.

1. Go to: [Main Menu](#) → [Advanced Setup](#) → [Comm & Network](#) → [Comm Failsafe](#).



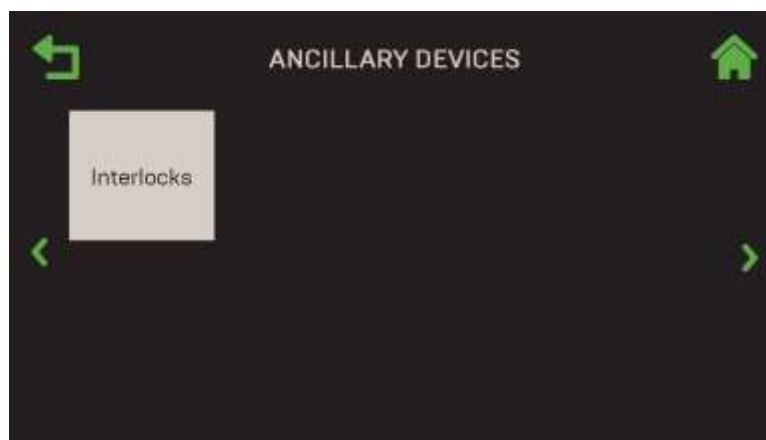
**Figure 4.4.4: Comm & Network: Communication Failsafe Screen**

2. Set the **Unit Failsafe Mode** parameter to either **Constant Setpoint** or **Shutdown**. This parameter specifies the unit's operating mode if there is a loss of communication with BAS or external sensor (i.e., an outdoor temperature sensor). If the loss of communication is to the WHM Manager unit, this setting applies to the entire plant. If set to **Constant Setpt**, the following additional parameter appears:
  - **Unit Failsafe Setpoint**: Specifies the plant's setpoint if there is a loss of communication with BAS or header sensor. (Range: 60°F to 170°F)

## 4.5 Ancillary Devices

The **Ancillary Devices** screen allows configuration of all unit inputs and outputs.

1. Go to: [Main Menu](#) → [Advanced Setup](#) → [Ancillary Devices](#).



**Figure 4.5: Advanced Setup: Ancillary Devices Screen**



### 4.5.1 Interlocks

The Edge Controller offers two interlock circuits, **Remote Interlock** and **Delayed Interlock**, both of which can interface with an Energy Management Systems (EMS) or a Building Automation System (BAS) and auxiliary equipment such as pumps or louvers. Both must be in the closed position to allow the unit to fire. They must be connected to the following pins on the unit's I/O board (see the *Innovation Installation, Operation & Maintenance Manual* (OMM-0143, GF-216) for more info):

- **Remote Interlock** wired to REMOTE INTL'K IN on the I/O Board
- **Delayed Interlock** wired to DELAYED INTL'K IN on the I/O Board

1. Go to: **Main Menu → Advanced Setup → Ancillary Device → Interlocks.**



**Figure 4.5.1: Ancillary Devices: Interlocks Screen – Innovation Shown**

2. The following parameters configure the **Remote Interlock**:

- **Remote Interlock Name:** Choose one of the following:
  - Flow
  - Louver
  - Damper
  - Other
- **Remote Intlk Use:** Displays what will shut down if the selected interlock switch is open. On Innovation units, it displays **Unit Shutdown** (see graphic above). On Benchmark units, you can choose **Boiler Shutdown** or **Sys Shutdown**.

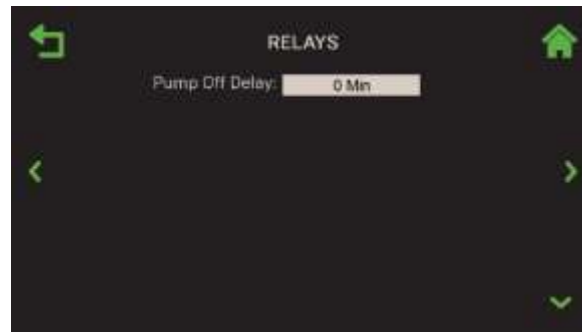
3. This screen contains two parameters that can be used to configure a **Delayed Interlock**, an adjustable delay timer that delays the ignition sequence, allowing sufficient time for a proving switch to be made to prevent a fault:

- **Delayed Interlock Name:** Choose one of the following:
  - Valve 1
  - Valve 2
  - Louver
  - Louver 2
- **Auxiliary Delay:** On Benchmark units, select the interlock delay. **If the Benchmark unit has a Sequencing Isolation Valve, this must be set to 120 seconds** (see *Benchmark 750-6000 Operation & Maintenance Manual* (OMM-0145, GF-218)). On Innovation units, it may be set to a value when using a pump instead of an isolation valve. (Range: 0 to 240 sec.)

## 4.5.2 Relays – Benchmark Only

The **Relays** screen gives you the ability to configure the optional **Pump Off Delay** relay.

1. Go to: **Main Menu** → **Advanced Setup** → **Ancillary Device** → **Relays**.
2. Set the **Pump Off Delay** parameter to the number of minutes the pump should continue operating after the unit is shut down. (Range: 0 to 30 minutes)



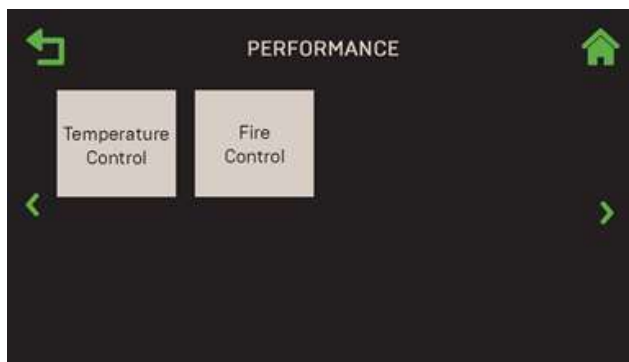
**Figure 4.5.2: Advanced Setup: Relay**

## 4.6 Performance

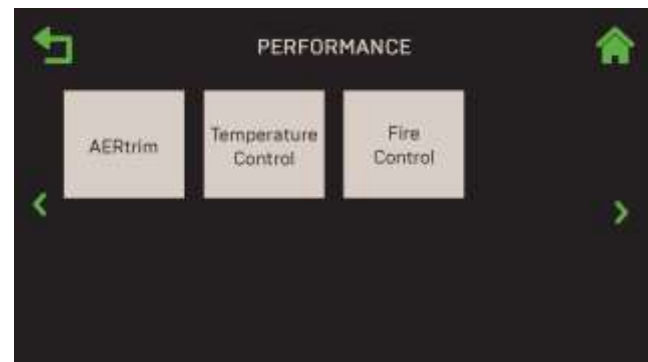
The **Performance** screen provides access to control and performance parameters related to Temperature and Fire Control functionality. All **Performance** screens apply only to the individual unit (they are not part of WHM functionality).

Some unit level parameters are not applicable if BST or WHM is enabled. In those cases, the parameters are greyed out or hidden; those screens may include parameters that don't appear on your unit.

1. Go to: **Main Menu** → **Advanced Setup** → **Performance**.



INNOVATION UNITS



BENCHMARK UNITS

**Figure 4.6: Advanced Setup: Performance**

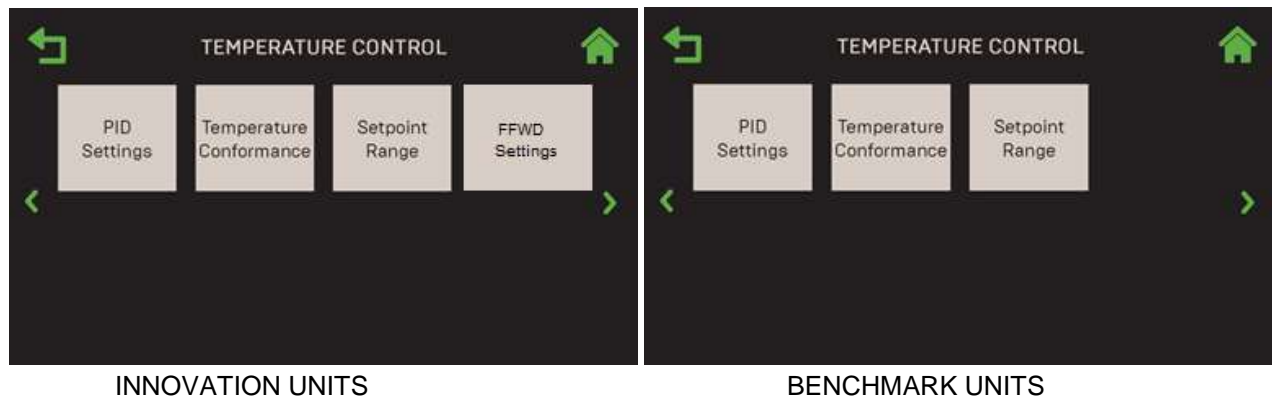
**NOTE:**

You can navigate from one **Performance** screen to the next in round-robin fashion using the **Page Left** and **Page Right** icons on each screen.

### 4.6.1 Temperature Control

The **Temperature Control** screen provides access to various temperature control and Setpoint Range parameters that apply to this unit only.

- Go to: **Main Menu → Advanced Setup → Performance → Temperature Control**.



**Figure 4.6.1: Performance: Temperature Control**

**NOTE:** You can navigate from one **Temperature Control** screen to the next in round-robin fashion using the **Page Left** and **Page Right** icons on each screen.

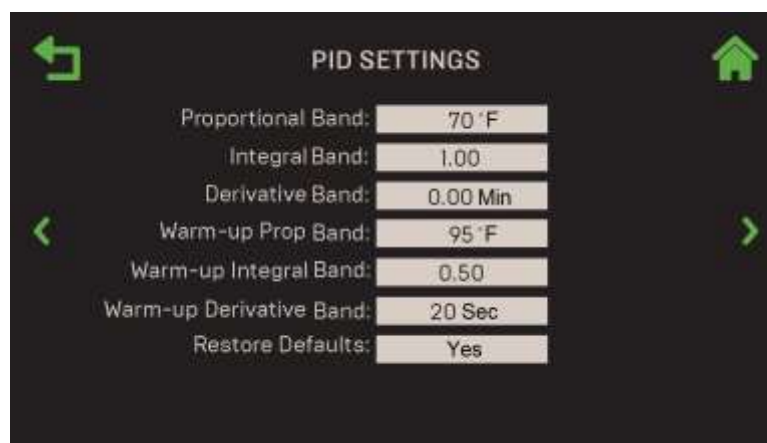
#### 4.6.1.1 PID Setting

The **PID Setting** screen provides access to PID parameters associated with the DHW application, plus the option to restore factory PID defaults.

**NOTE**

This screen applies to both Innovation Water Heaters and Benchmark Boilers.

- Go to: **Main Menu → Advanced Setup → Performance → Temperature Control → PID Setting**.



**Figure 4.6.1.1: Temperature Control: PID Setting**

- This screen includes the following parameters:

- **Proportional Band:** Generates a fire rate based on the error that exists between the setpoint temperature and the actual outlet temperature. If the error is less than the

SECTION 4 – ADVANCED SETUP

---

proportional band setting, the fire rate will be less than 100%. If the error is equal to or greater than the proportional band setting, the fire rate will equal 100%.

(Range: 1°F to 120°F)

- **Integral Band:** Specifies the fraction of the output, due to setpoint error, to add or subtract from the output each minute to move towards the setpoint.  
(Range: 0.00 to 2.00, default = 1.00)
- **Derivative Band:** This value responds to the rate of change of the setpoint error. It specifies the time that this action advances the output.  
(Range: 0.00 to 2.00 min.)
- **Warm-up Prop Band, Warm-up Integral Band, Warm-up Derivative Band:** These three parameters eliminate Temperature Overshoots during the “Warmup” period of a cold ignition cycle by temporarily modifying the PID Gain parameter during warmup.
- **Restore Defaults:** Set to **Yes** to reset all parameters to the factory default.

### 4.6.1.2 Temperature Conformance

The **Temperature Conformance** screen provides access to parameters that define acceptable temperature ranges for the unit.

**NOTE**

This screen applies to both Innovation Water Heaters and Benchmark Boilers.

1. Go to: **Main Menu → Advanced Setup → Performance → Temperature Control → Temperature Conformance.**



**Figure 4.6.1.2: Temperature Control: Temperature Conformance**

2. This screen includes the following parameters:
  - **Deadband High & Deadband Low:** These two settings create an “Outlet Temperature” zone in which no Valve Position corrections will be attempted. This zone operates with an Outlet Temperature between Active Setpoint + Deadband High and Active Setpoint – Deadband Low. (Range: 0 to 25°F for both)
  - **Temperature Hi Limit (Innovation Only):** Sets the maximum allowable temperature at which the unit can run. (Range: 40°F to 210°F)
  - **Max Delta-T (Benchmark Only):** Sets the maximum allowable difference between Inlet and outlet water temperature ( $\Delta T$ ). If the unit reaches this limit, the fire rate will reduce to stay within the limit. The unit will shut down if it goes 20° above this limit. (Range: 20°F to 120°F)

### 4.6.1.3 Setpoint Range

The **Setpoint Range** screen includes all **Setpoint** and **Setpoint Setback** parameters that apply to this unit only. This screen includes ? (Help) functionality.

#### NOTE

- This screen applies to both Innovation Water Heaters and Benchmark Boilers.
- Many of this screen's parameters also appear in [Section 4.3.4.5: Setpoint Range](#), which is available only after WHM or BST Cascade functionality has been enabled (for Innovation units, see [Section 4.3.2.1](#), for Benchmark units, see [Section 4.3.2.2](#)).

1. Go to: **Main Menu → Advanced Setup → Performance → Temperature Control → Setpoint Range**.



**Figure 4.6.1.3: Operating Controls: Setpoint Range Screen**

2. This screen includes the following parameters:

- **Setpt Low Limit** and **Setpt High Limit**: Together these two parameters determine the temperature range within which the setpoint can vary. Note that on Benchmark units, these two parameter names are preceded by either **SH** or **Other**, depending on the Application chosen in either the Unit Application screen ([Section 4.2.6.2: Unit Application Configuration – Benchmark](#)) or the BST Application Configuration screen ([Section 4.3.3.2: BST Application Configuration – Benchmark](#)). (Range: 20°F to 245°F)
- **Setpoint Limiting**: When **Enabled**, this feature acts as a temperature limiting governor. Should a unit's outlet temperature equal **Setpoint High Limit**, a PID function will intervene and maintain the outlet temperature at the **Setpoint High Limit** minus the **Setpoint Limit Band** (see below):
  - **Setpoint Limit Band**: Sets the number of degrees *below* **Setpoint High Limit** the unit's outlet temperature must fall before the unit restarts (Range = 0°F to 10°F)
- **Setpoint Schedule**: When **Enabled**, this feature will lower the Setpoint during periods of reduced demand for heat, such as at night. Note, on Benchmark units, these same three parameters also appear in [Section 4.3.4.5: Setpoint Range](#) and can be changed in either screen. If **Enabled**, the following additional parameters appear:
  - **Setback Setpoint**: The Setpoint that will be in effect during the Setback period. (Range = 60°F to 150°F)
  - **Setback Start Time**: The **Setback** period's *start* time (example: 11:00 PM).
  - **Setback Stop Time**: The **Setback** period's *end* time (example: 5:00 AM).

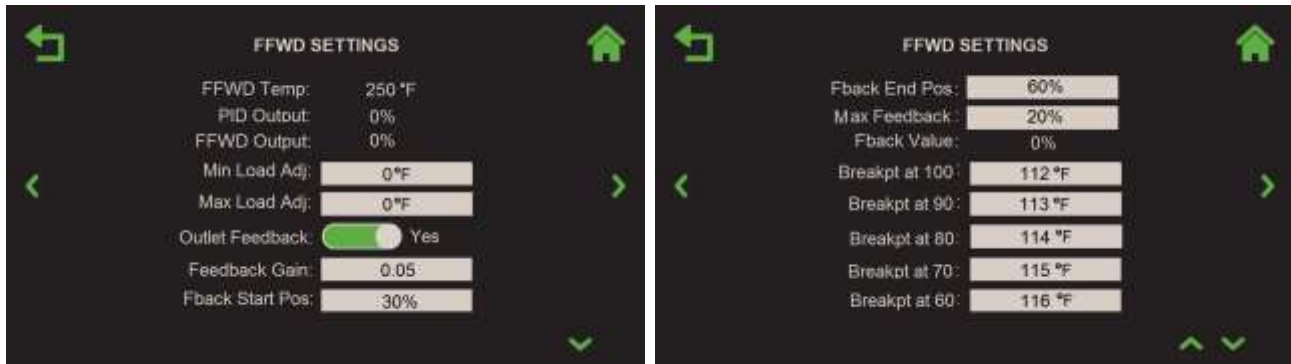
#### 4.6.1.4 FFWD Settings – Innovation Only

**NOTE:**

This screen applies only to Innovation Water Heaters.

The **FFWD Settings** screen's parameters setup and configure Feed Forward functionality. These parameters apply to this unit only.

1. Go to: **Main Menu → Advanced Setup → Performance → Temperature Control → FFWD Settings.**



**Figure 4.6.1.4: Temperature Control: FFWD Settings Screen**

2. The following parameters appear:

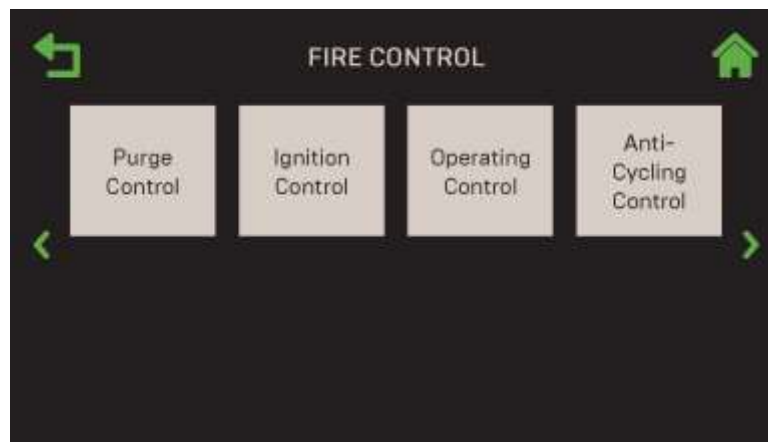
- **FFWD Temp:** The current FFWD temperature.
- **PID Output:** Displays the calculated PID output.
- **FFWD Output:** Displays the current FFWD output.
- **Min Load Adj:** Adjusts the output by adding an offset to the breakpoint chart at minimum flow.
- **Max Load Adj:** Adjusts the output by changing the scaling of the breakpoint chart at maximum flow.
- **Outlet Feedback:** Enables Outlet Feedback functionality
- **Feedback Gain:** The percentage of feedback from the water outlet sensor the algorithm factors to determine fire rate.
- **Fback Start Pos:** The Feedback start position.
- **Fback End Pos:** The Feedback end position.
- **Max Feedback:** Specifies the maximum Feedback position
- **Fback Value:** Displays the current feedback value.
- **Breakpt at 100 – Breakpt at 0:** Allows breakpoint temperature settings to be entered for 100% to 0% in 10% increments.
- **Temp Gov:** Enables temperature governor limiting functionality.
- **GOV Limit-5 – GOV Limit-15:** When the Outlet Temperature exceeds the **Temperature Hi Limit** by 5 to 15°F, the effective Fire Rate will be reduced by the value entered in GOV Limit-5 through GOV Limit-15.



## 4.6.2 Fire Control

The **Fire Control** screen provides access to functionality that affect the firing of this unit. All four controls apply to this unit only.

1. Go to: **Main Menu → Advanced Setup → Performance → Fire Control**.



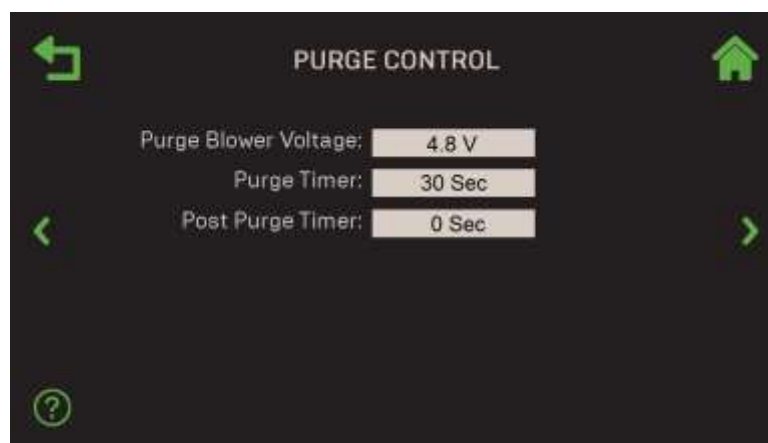
**Figure 4.6.2: Performance: Fire Control**

**NOTE:** You can navigate from one **Fire Control** screen to the next in round-robin fashion using the **Page Left** and **Page Right** icons on each screen.

### 4.6.2.1 Purge Control

The **Purge Control** screen contains parameters associated with the purge process for this unit.

1. Go to: **Main Menu → Advanced Setup → Performance → Fire Control → Purge Control**.



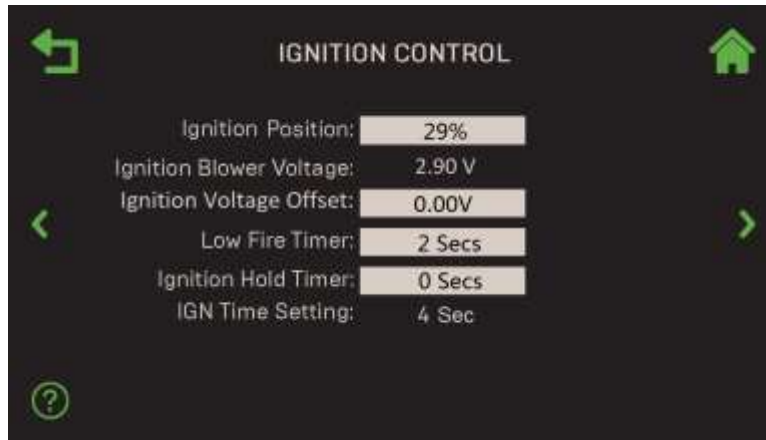
**Figure 4.6.2.1: Fire Control: Purge Control**

2. This screen includes the following parameters:
  - **Purge Blower Voltage:** Allows adjustment of the blower speed (blower output voltage) during the Purge cycle. (Range: 2.0 to 10.0 V)
  - **Purge Timer:** Allows adjustment of the pre-ignition purge time. (Range: 5 to 60 sec.)
  - **Post Purge Timer:** Allows adjustment of the purge time when a unit shuts down. (Range: 0 to 60 sec.)

### 4.6.2.2 Ignition Control

The **Ignition Control** screen displays parameters related to ignition that apply to this unit only.

1. Go to: **Main Menu** → **Advanced Setup** → **Performance** → **Fire Control** → **Ignition Control**.



**Figure 4.6.2.2: Fire Control: Ignition Control**

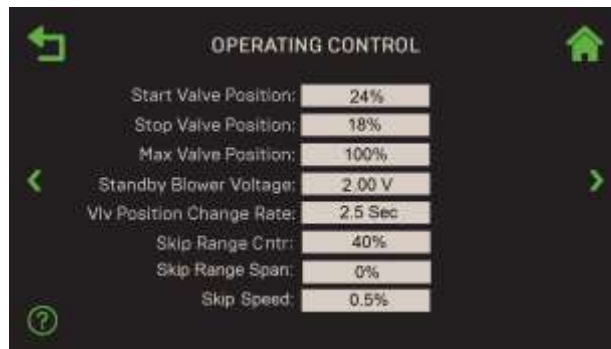
2. The following ignition control parameters are available:

- **Ignition Position:** Specify the air fuel valve position at which the unit ignites. This position may be between two combustion calibration points. (Range: 5% to 60%)
- **Ignition Blower Voltage:** A read-only display of the current blower voltage at the selected Ignition Position.  
**Ignition Voltage Offset:** Allows you to fine-tune the Blower Voltage at the selected Ignition Position to ensure a smooth ignition. (Range: -5.00V to 5.00V)
- **Low Fire Timer:** Specifies how long the unit remains in the low fire position after ignition. (Range: 2 to 600 sec.)
- **Ignition Hold Timer:** Specifies the length of time the unit stays in ignition position before modulating. (Range: 0 to 60 sec.)
- **IGN Time Setting:** A read-only display of the maximum allowable time between confirmation of gas valve opening (POC) and a stable flame detected; some legacy units allowed up to 7 seconds.

### 4.6.2.3 Operating Control

The **Operating Control** screens provides parameters to view or modify operating levels that apply to this unit only.

1. Go to: **Main Menu → Advanced Setup → Performance → Fire Control → Operating Control**.



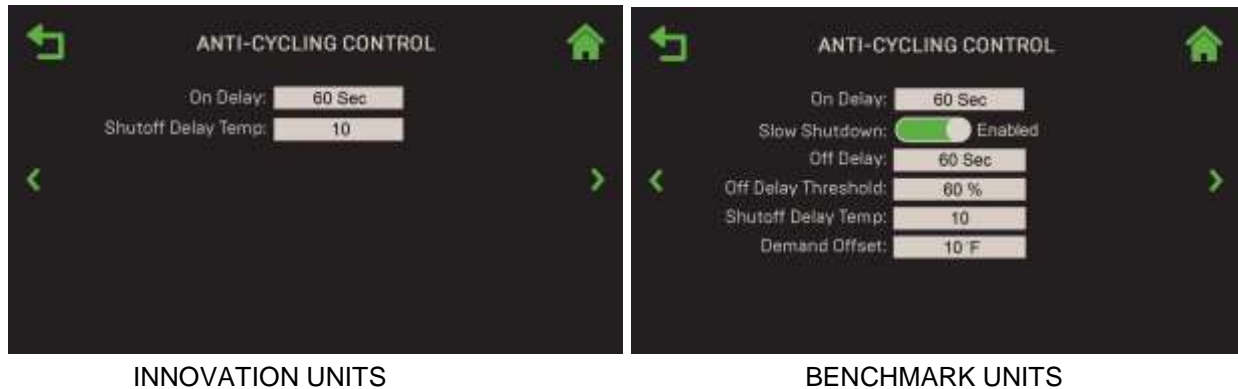
**Figure 4.6.2.3: Fire Control: Operating Control Screen**

2. The following operating control parameters are available:
  - **Start Valve Position:** Allows the Start Level to be set to a valve position. (Range: 0 or **Stop Valve Position** to 40%)
  - **Stop Valve Position:** Allows the Stop Level to be set to a valve position. (Range 0% to **Start Valve Position**)
  - **Max Valve Position:** Sets the maximum allowable valve position for the unit. (Range: 40 to 100%)
  - **Standby Blower Voltage:** Sets the blower voltage when the unit is in Standby Mode, during which the blower motor remains “ON” at low speed, to limit power cycles. AERCO recommends keeping the default. However, individually vented units in positive pressure mechanical rooms may set this between **2.00** and **0** volts to compensate. (Range: 0.0 to 10.0V)
  - **Vlv Position Change Rate:** Defines the rate at which the **valve position** will progress from one step to the next. (Range: 0.5 to 60 sec.)
  - **Skip Range Cntr, Skip Range Span, Skip Speed:** Together, these three parameters can be used to define a Fire Rate “skip zone” the Edge Controller will avoid (**Skip Range Cntr** = the center of the range). These can be used in the rare instance when a unit emits an objectionable noise at a certain Fire Rate and no other remedy resolves the problem. The Edge Controller will then skip-over the “skip” Fire Rate.

#### 4.6.2.4 Anti-Cycling Controls

The **Anti-Cycling Controls** screen provides parameters that can be used to reduce unnecessary cycling on this unit only.

- Go to: **Main Menu → Advanced Setup → Performance → Fire Control → Anti-Cycling Controls**.



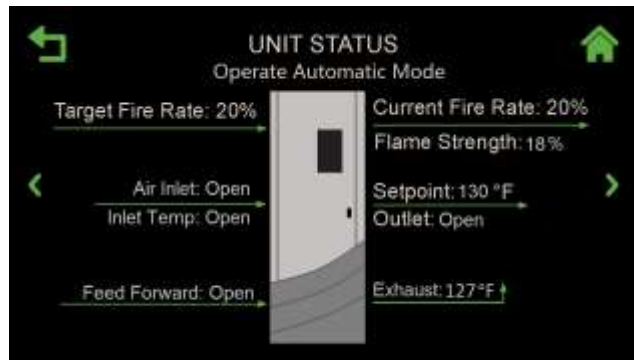
**Figure 4.6.2.4: Fire Control: Standalone Anti-Cycling Controls**

- The following anti-cycling parameters are available on both Innovation and Benchmark units. They can be used to delay the shutdown of a unit in order to reduce excessive cycling:
  - On Delay:** Specifies the minimum length of time a unit must stay **off** after shutting down or going into standby. (Range: 0 to 600 sec.)
  - Shutoff Delay Temp:** Specifies the number of degrees above setpoint which the Outlet Temperature can rise without triggering a unit shut down (Range: 0 to 25°F).
- The following anti-cycling parameters are available only on Benchmark units:
  - Slow Shutdown:** If Enabled, unit shut down is slowed down until **Off Delay** threshold is achieved. When Enabled, the following additional parameters appear:
    - Off Delay:** Defines a Shutoff delay, during which the unit remains at minimum fire rate after the unit has sequenced to shutoff. It is activated only when **Off Delay Threshold** is reached. (Range: 0 to 9999 secs, Default = 1 min.)
    - Off Delay Threshold:** Fire rate that activates **Off Delay** function (Range: 40 to 100 %, default = 60%).
  - Demand Offset:** This parameter reduces excessive ON/OFF cycling in AUTO mode. When this entry  $\neq 0$ , the unit will not turn on again until *Valve Position In* reaches the **Start Level** value AND the Outlet Temperature goes below *Active Setpoint – Demand Offset*. In addition, the unit will fire at the ignition Valve Position level or below for a period of one minute. When this entry is set to zero, the unit will turn on again as soon as the *Valve Position In* reaches the *Start Level* value. There will not be a one minute delay when firing at the 29% Valve Position level.

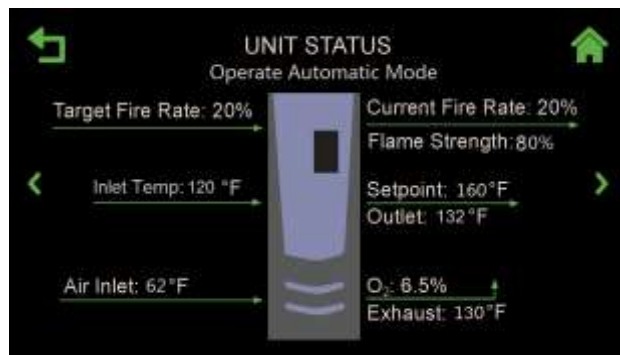
## SECTION 5: UNIT STATUS

The **Unit Status** screen provides access to a variety of parameters that show the status of the unit. In addition, in a BST or WHM Cascade, on the unit designated as a “Manager,” it provides access to screens that display parameters showing the status of the entire cascade.

It is accessed by pressing **Unit Status** on the **Main Menu**.



**Innovation Unit Status Screen**



**Benchmark Unit Status Screen**



**Figure 5.0: Unit Status Screen**

This Section includes the following topics:

[5.1: Ignition Sequence](#)

[5.1.1: Demand](#)

[5.1.2: Auxiliary Delay Timers](#)

[5.1.3: Purging](#)

[5.1.4: Spark Cleaning](#)

[5.1.5: Ignition](#)

[5.2: Unit Status](#)

[5.3: Plant Status](#)

[5.4: WHM Cascade Status](#)

[5.6: Runtime Statistics](#)

[5.7: Unit Event History](#)

[5.8 Plant Event History](#)

[5.10: Ignition Sequence Summary](#)

**WARNING:**

Before starting the instructions in this section for the first time, you must ensure that the unit has the latest Edge Controller firmware. Complete the instructions in [Section 4.1.7: Firmware Update](#) to obtain and install the latest firmware.

Unlike most areas of the system, navigation is performed exclusively with the **Page Left** and **Page Right** arrows to move from screen to screen in round-robin fashion. The order of navigation depends on whether the unit is part of a WHM Cascade or a standalone unit. The order of navigation is as follows:

Screen Name	BMK	INN
Unit Status	✓	✓
Plant Status *	✓	
BST/WHM Cascade Status	✓	✓
Runtime Statistics	✓	✓
Unit Event History	✓	✓
Plant Event History	✓	✓
Last Ignition Status	✓	✓

\* Not available when ACS is used.

If there is a fault condition, the fault indicator will appear below the screen's title bar at the top of the screen.

## 5.1 Ignition Sequence

When the unit starts the ignition sequence, the **Ignition Sequence** screen automatically appears (see Figure 5.1.1, below). This screen displays the status of each step in the ignition sequence on five rectangles, with the first step, **Demand**, at the bottom. The rectangle for each step is grey before starting, then turns green when the step successfully concludes. Various text notes appear on the right side of the screen at each step. The last screen, **Last Ignition Status** (Figure 5.1.6), serves as a summary screen. This summary remains in effect until the next successful ignition.

The ignition process, which starts with a call for heat, consists of the following steps:

1. **Demand**
2. **Auxiliary Delay:** (Demand turns green)
3. **Purging:** (Demand and Aux Delay turns green)
4. **Spark Cleaning** (Demand, Aux Delay and Purging turns green)
5. **Ignition** (Demand, Aux Delay, Purging and Spark Cleaning turns green)
6. **Summary** (All stages turns green)

### 5.1.1 Demand

1. Upon a demand for heat, the **Demand** rectangle turns green, and, if the sequence has a delay timer, those timers display appropriate values.

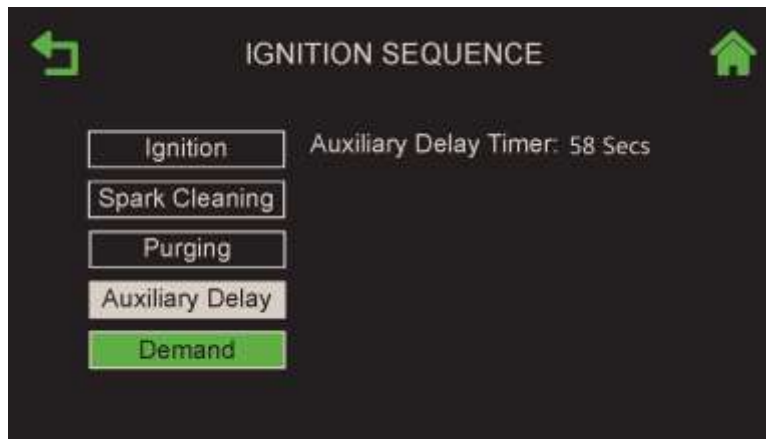


*Figure 5.1.1: Ignition Sequence Step 1 – Demand*

2. Upon expiration of the internal 4 second IGST Demand delay and the unit progresses to the **Auxiliary Delay** sequence.

### 5.1.2 Auxiliary Delay Timers

1. Upon expiration of the internal 4 second IGST Demand delay, **On Delay Timer** starts, followed by **Auxiliary Delay Timer** (if any). In both cases, the displays the count down.



*Figure 5.1.2: Ignition Sequence Step 2 – Auxiliary Delay*

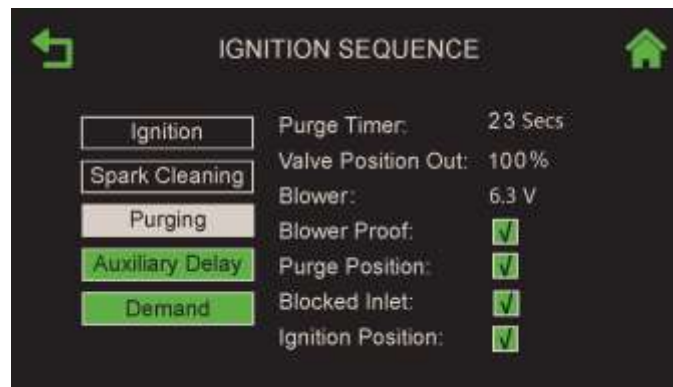
2. When the **On Delay Timer** and all the interlock switches are closed, the **Auxiliary Delay** rectangle turns green and the unit progresses to the **Purging** sequence.
  - If the interlock switches are closed and On Delay time has expired, the **Auxiliary Delay** rectangle immediately changes to green, allowing for the purge cycle to begin.
  - If the any of the interlock switches are not closed when the auxiliary timer expires, the **Auxiliary Delay** rectangle turns red and the correspond interlock fault is displayed.



### 5.1.3 Purging

1. All switches required to be met during the purge cycle (as shown above) have a checkbox, which changes to green once the switch is met. If any switch fails to be proven, its checkbox will turn red with a white X and the unit will display a fault message explaining the failure. The safety circuit switches are:

- Blower Proof
- Purge Position
- Blocked Inlet
- Ignition Position

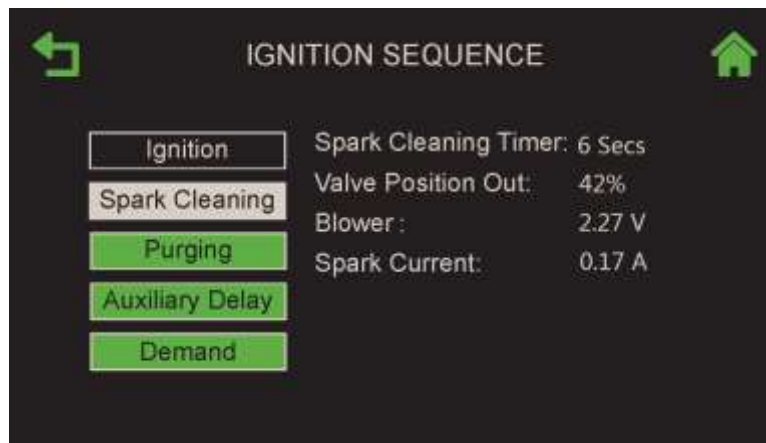


*Figure 5.1.3: Ignition Sequence - Screen 3, Purge*

2. The following additional parameters are displayed:
- **Purge Timer:** The purge cycle's elapsed time in seconds
  - **Valve Position Out:** The Air Fuel Valve's position
  - **Blower Voltage:** The blower voltage as the unit purges
3. Upon expiration of purge timer, if all the switches are met, the **Purging** rectangle turns green and the system progresses to **Spark Cleaning**. If the purge timer expires before all the switches have been met, the **Purging** rectangle turns red.

### 5.1.4 Spark Cleaning

1. The **Spark Cleaning Timer** begins, typically for 10 seconds.



**Figure 5.1.4: Ignition Sequence - Screen 4, Spark Cleaning**

2. The **Valve Position Out** and **Blower Voltage** continue from the **Purging** sequence.
3. The **Spark Current** (amps draw from spark across igniter) is displayed. If this value goes outside the set threshold range (typically 0.1 to 0.4 A), the **Spark Cleaning** rectangle turns red and **Spark Current Fault** is displayed.
4. Upon expiration of the **Spark Current Timer**, if the spark current remains within range, the **Spark Cleaning** rectangle turns green and the system progresses to the **Ignition** trial.

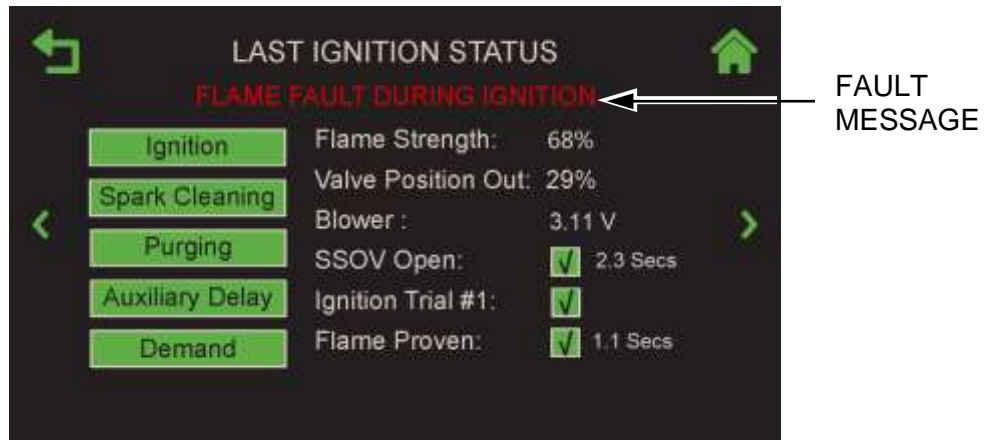
### 5.1.5 Ignition



**Figure 5.1.5: Ignition Sequence - Screen 5, Ignition**

1. The screen now displays the following additional parameters:
  - a) **Flame Strength** – Remains 0 until the flame sensor(s) senses flame, then displays the flame strength between 0-100%. A flame strength less than 70% will lead to flame loss.

- b) **SSOV Open** – The check box turns green if the SSOV opened in the required 4 second time period. The time it took appears next to the check box. If the SSOV does not open with 4 seconds, the box turns red and the unit displays a fault message.
- c) **Ignition Trial #** – Displays current trial attempt (from 1 to 3) and begins a timer, starting at 0 once the SSOV is proven open. The check box turns green if flame is proven within 4 seconds, or turns red if flame is **not** proven. If the trial is not successful, the trial number is incremented and the timer is reset. If the flame is not proven after 3 unsuccessful attempts, a fault message appears, as shown below.

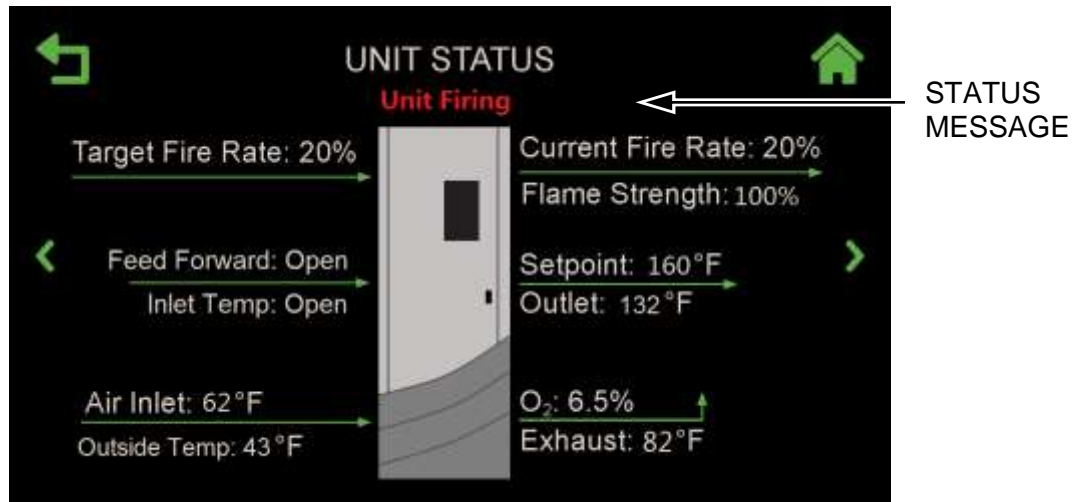


**Figure 5.1.5: Ignition Sequence - Screen 6, Summary with Fault Message**

- Once flame is proven:
  - The **Ignition** box turns green.
  - Flame Proven** appears with green checkmark box and the time it took for flame to be proven.
  - The **Summary** and all parameters are automatically saved, including the ignition flame strength, SSOV time to open and ignition time
- The **Summary** screen disappears within 5 seconds (unless you press **Home** or **Back**). However, it remains available in the round-robin operating screen pages until the next successful ignition.

## 5.2 Unit Status

The **Unit Status** screen is the default Operating screen. It also appears when the unit powers on (post splash screen), comes out of sleep mode or has a successful flame. The system automatically transitions to the Ignition screen during the Ignition sequence.



**Figure 5.2: Example Unit Status Screen – Innovation Shown**

In normal operation, the area just below the screen heading displays operating status. However, if there's an operating error, it displays the error condition in red, as shown above.

The following notes apply to this screen:

- The **Flame Strength** is displayed in %, up to 100%.
- The **Setpoint** is not displayed if the unit is a "Client" in a WHM Cascade.

## 5.3 Plant Status (Benchmark Only)

The **Plant Status** screen is displayed only on BST Manager units, in a round-robin with Unit Status screen.



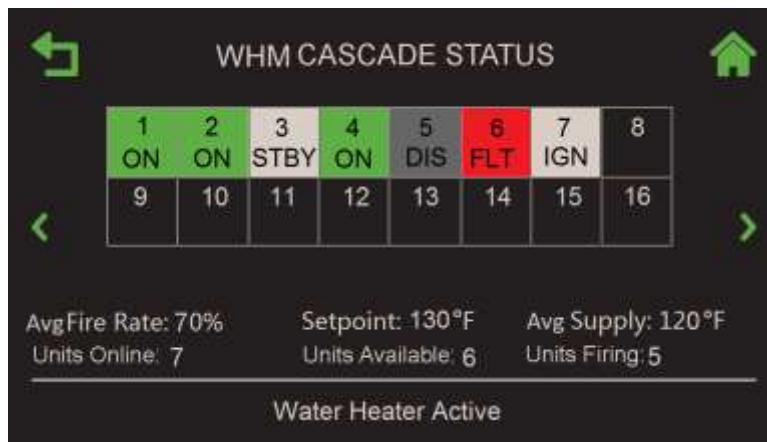
**Figure 5.3: Plant Status Screen – Benchmark Only**

The **Outside Temp** (Outdoor Air Temp Sensor) and **Inlet Temp** are displayed when the associated sensors are enabled as part of a WHM Cascade. If a given sensor is enabled but no sensor is detected, the screen displays “Open” for the missing data.

## 5.4 BST and WHM Cascade Status

### 5.4.1 WHM Cascade Status – Innovation Only

The **WHM Cascade Status** screen is displayed only on Innovation units, in a round-robin with Unit Status screen. It provides a view of the WHM Cascade as a whole, and the status of all 16 possible Water Heaters, including pertinent WHM system settings and readings.



**Figure 5.4.1-1: WHM Cascade Status Screen**

The following notes apply to this screen:

- Each of the 16 possible units in the WHM Cascade is represented by a square in the grid and identified by its COM Address. Unused boxes are numbered but otherwise blank.
- The color of Lead unit box blinks on/off.
- The colors of the box and the text in the boxes display the designation and status of each unit within the WHM Cascade:

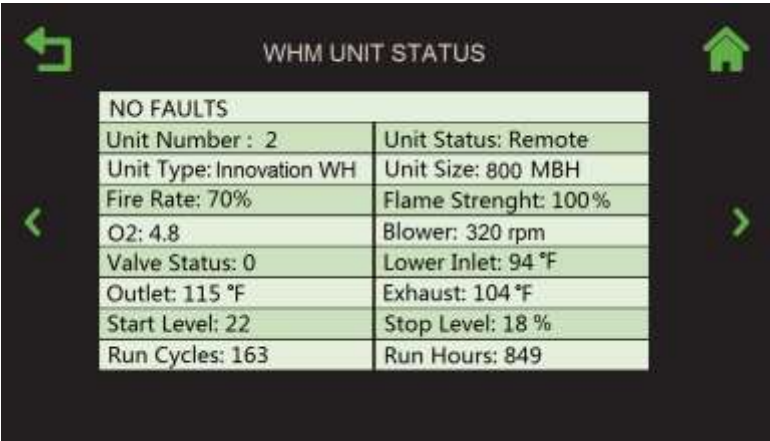
Unit Status Display Characteristics		
Label	Status	Color
	Off Line	BLACK
DIS	Disabled	GREY
FLT	Fault	RED
STBY	Standby	WHITE
ON	Operating	GREEN
S LIM	Setpt Lim	AMBER
IGN	Igniting	WHITE

- The color in the Lead unit’s box blinks.

SECTION 5 – UNIT STATUS

- The Lag unit displays **LAG** in place of the COM Address.
- The **Fire Rate** area displays the current fire rate for the WHM Manager. The WHM Manager unit will drive all ignited units at the fire rate specified.
- **Supply** displays the current Header Temperature of the WHM Cascade.
- **Units Online** displays the total number of units actively connected to the WHM Manager unit via the Modbus Network. This includes units that have Faulted and stopped communicating with the Manager.
- **Units Available** displays the total number of connected units either ON, being Ignited or in Standby Mode waiting to be Ignited.
- **Units Firing** displays the total number of units currently ignited in the Cascade.
- The bottom line displays the current state of the WHM Manager.

On the **WHM Cascade Status** screen (Figure 5.3.2-1, above), if you press on any unit, the **WHM Unit Status** screen appears, showing the details of that particular unit. From here, you can navigate to the status screens of all the other units in the cascade using the **Left** and **Right** arrows.



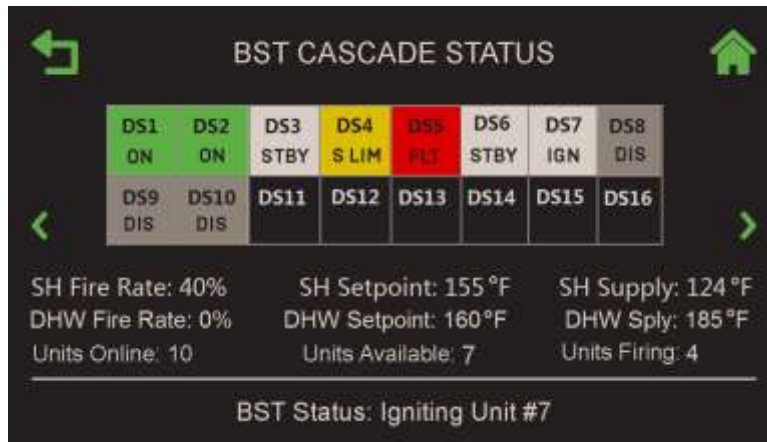
NO FAULTS	
Unit Number : 2	Unit Status: Remote
Unit Type: Innovation WH	Unit Size: 800 MBH
Fire Rate: 70%	Flame Strenght: 100%
O2: 4.8	Blower: 320 rpm
Valve Status: 0	Lower Inlet: 94 °F
Outlet: 115 °F	Exhaust: 104 °F
Start Level: 22	Stop Level: 18 %
Run Cycles: 163	Run Hours: 849

**Figure 5.4.1-2: WHM Unit Status Screen**

### 5.4.2 BST Cascade Status – Benchmark BST Manager Only

The **BST Cascade Status** screen appears only on the BST Manager unit in round-robin fashion. It provides a view of the BST cascade as a whole. It displays the status of all of the 16 possible boilers, as well as pertinent BST system settings and readings.





**Figure 5.4.2-1: BST Cascade Status Screen**

The following notes apply to this screen:

- The data displayed on this screen depends on the Application(s) chosen in [Section 4.3.3.2: Application Configuration](#). It can display data for only two applications at a time, **Space Heating** and **DHW**, or **Other**.
- Each of the 16 possible boilers in the BST cascade is represented by a box in the grid and identified by their COM Address. Unused boxes are shown blank.
- The color of Lead boiler box blinks on/off.
- The colors of the box and the text in the boxes display the designation and status of each boiler within the BST cascade:

Unit Designations	
Label	Description
DS	Dedicated Space Heating
DD	Dedicated DHW
SS	Swing Boiler - SH
SD	Swing Boiler - DHW
Sd	Swing Boiler, serving DHW, default SH
Ss	Swing Boiler, serving SH, default DHW

Unit Status		
Label	Status	Color
	Off Line	BLACK
DIS	Disabled	GREY
FLT	Fault	RED
STBY	Standby	WHITE
ON	Operating	GREEN
S LIM	Setpt Lim	AMBER
IGN	Igniting	WHITE

- The Lag unit displays **LAG** in place of the COM Address.
- The **Fire Rate** area displays the current fire rate for each Application in the cascade: **SH**, **DHW** and/or **Other**. The BST Manager unit will drive all ignited boilers at the fire rate specified for each Application.
- **SH Setpoint**, **DHW Setpoint** and/or **Other Setpoint** displays the current Active Setpoint for each Application in the cascade.
- **Supply** displays the current Header Temperature of the BST cascade for each Application in the cascade.



SECTION 5 – UNIT STATUS

- **Units Online** displays the total number of units actively connected to the BST “Manager” unit via the BST Modbus Network. This includes units that have Faulted and stopped communicating with the Manager.
- **Units Available** displays the total number of connected units either ON, being Ignited or in Standby Mode waiting to be Ignited.
- **Units Firing** displays the total number of units currently Ignited in the BST System.
- The **BST Status** line displays the current state of the BST system as follows:

<ul style="list-style-type: none"> <li>• Failsafe Mode Active</li> <li>• One Boiler Mode</li> <li>• BST In Deadband</li> <li>• BST In Control</li> <li>• All Boilers are Off</li> <li>• Igniting First Boiler</li> <li>• Boiler Ignited</li> <li>• Igniting Next Boiler</li> </ul>	<ul style="list-style-type: none"> <li>• Raise Fire Rate</li> <li>• All Boilers are On-Raise FR</li> <li>• Lower Fire Rate</li> <li>• BST is On Temperature</li> <li>• All Boilers are On at MAX FR</li> <li>• BST Overtemp</li> <li>• BST Remote Signal Fault</li> <li>• BST in Failsafe Mode</li> </ul>
--	---

On the **BST Cascade Status** screen (Figure 5.4.2-1, above), if you press on any unit, the **BST Unit Status** screen appears, showing the details of that particular unit. From here, you can navigate to the status screens of all the other units in the cascade using the **Left** and **Right** arrows.

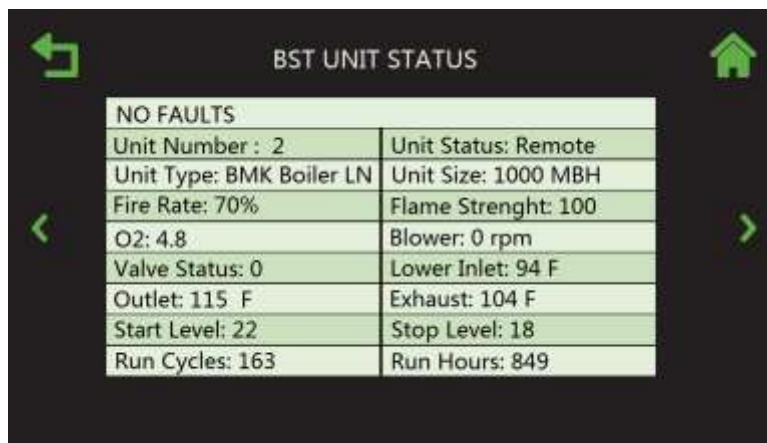


Figure 5.4.2-2: BST Unit Status Screen

## 5.5 Isolation Valve Status – Benchmark BST Manager Only

The **Isolation Valve Status** screen appears only on the BST Manager unit in round-robin fashion. It displays which isolation valves have been designated as always open (see [Section 4.3.4.4.2: Valve Configuration](#)), even during plant standby conditions. It also displays the value of the **Min # Valves Open** parameter, set in [Section 4.3.4.4.2: Valve Configuration](#).

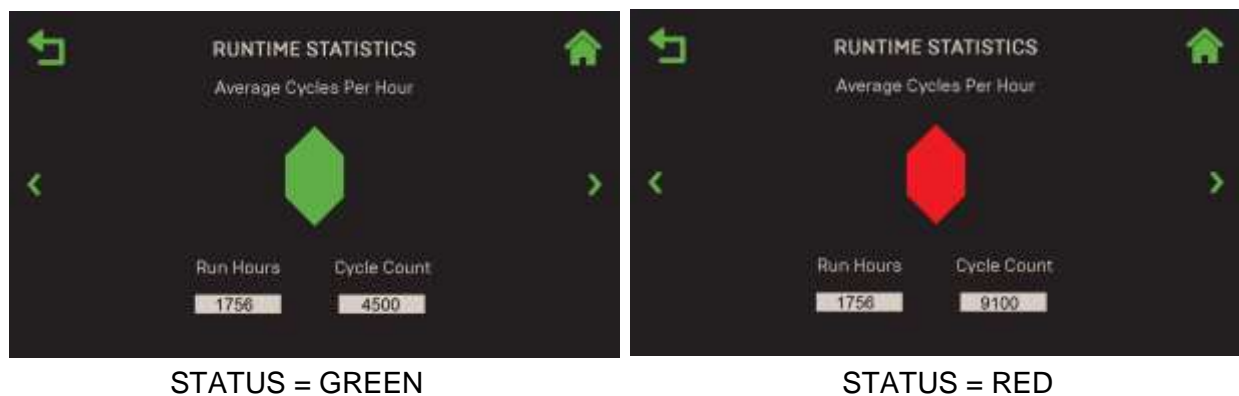
Note, this screen shows the command that the BST Manager is sending the isolation valve. Any failure on the valve will not be reflected on this screen.



**Figure 5.5: Isolation Valve Status Screen**

## 5.6 Runtime Statistics

The **Runtime Statistics** screen displays the unit's total run hours, total cycle count and a color-coded honeycomb signifying the Average Cycles Per Hour.



**Figure 5.6: Runtime Statistics Screen**

The following notes apply to this screen:

- The average cycles per run hour is calculated based on cycle count during rolling 1-enabled-hour.
- The Average Cycles Per Hour honeycomb is color coded are follows:
  - **Green** = Less than 3 cycles per hour
  - **Yellow** = Between 3 and 5 cycles per hour
  - **Red** = More than 5 cycles per hour
- If the cycle count exceeds 5 cycles per hour, an event is logged for a given unit (a high cycle count does not lock out a unit).

## 5.7 Unit Event History

The **Unit Event History** screen is a scrollable display of unit events, faults and warnings, arranged chronologically, most recent on top. Each event includes the event name, date and time, and a color-coded honeycomb in front of the event name:

- **Red** = Faults
- **Yellow** = Warnings
- **Green** = Events

Event	Date/Time
WHM NetworkOutdoor Com	21-Jul, 1:45 PM
SSOV Switch Open	21-Jul, 11:53 AM
Airflow Fault During Purge	21-Jul, 8:21 AM
WHM NetworkOutdoor Com	21-Jul, 11:53 AM
onAER Communication failed	20-Jul, 1:42 PM
Flame Loss During ignition	20-Jul, 7:37 AM
O2 Percentage Low	20-Jul, 6:58 AM
WHM NetworkOutdoor Com	19-Jul, 10:21 PM
Warning O2 Level High	17-Jul, 9:43 AM
WHM NetworkOutdoor Com	16-Jul, 7:42 PM

INNOVATION SCREEN

Event	Date/Time
BST NetworkOutdoor Comm	21-Jul, 1:45 PM
BST NetworkOutdoor Comm	21-Jul, 11:53 AM
Airflow Fault During Purge	21-Jul, 8:21 AM
BST NetworkOutdoor Comm	21-Jul, 11:53 AM
onAER Communication failed	20-Jul, 1:42 PM
Flame Loss During ignition	20-Jul, 7:37 AM
O2 Percentage Low	20-Jul, 6:58 AM
BST NetworkOutdoor Comm	19-Jul, 10:21 PM
Warning O2 Level High	17-Jul, 9:43 AM
BST NetworkOutdoor Comm	16-Jul, 7:42 PM

BENCHMARK SCREEN

**Figure 5.7-1: Unit Event History Screen**

The following notes apply to this screen:

- The maximum event history (unit or plant) is 200 events.
- You can drag the scroll bar up and down to view additional events.
- You can press on any row to see the details of that event. The **“Event” Details** screen appears; the title of the screen depends on the “Event”.

WARNING O2 LEVEL HIGH DETAILS	
Date:	7/17/2018
Time:	9:43 AM
Event Code:	64
Valve:	25%
Outlet:	101°F
Lower Inlet:	100°F
Air:	52°F
Exhaust:	97°F
Flame Strength:	100%
O2:	6.1%
O2 Trim:	Idle

**Figure 5.7-2: Event Details Screen – O2 Level High Event Shown**

In this screen, you can navigate to the details of other events using the Left and Right arrows without having to go back to the **Unit Event History** screen. Note, this is not a round robin.

SECTION 5 – UNIT STATUS

The **Event Details** screen contains the following parameters:

- Date
- Time
- Event Code
- Valve position
- Outlet temperature
- Inlet temperature
- Air temperature
- Exhaust temperature
- Flame strength
- O2 level
- O2 Trim state

## 5.8 Plant Event History

The **Plant Event History** screen is displayed in the round-robin queue on WHM and BST Manager units only. Like **Unit Event History** screen, it displays the same layout, number of events and color coding as the **Unit Event History** screen, however the events come from any unit in the cascade. The **Unit ID** column indicates which unit the event occurred on, or **Plant** for plant level events such as communication fault with BAS.

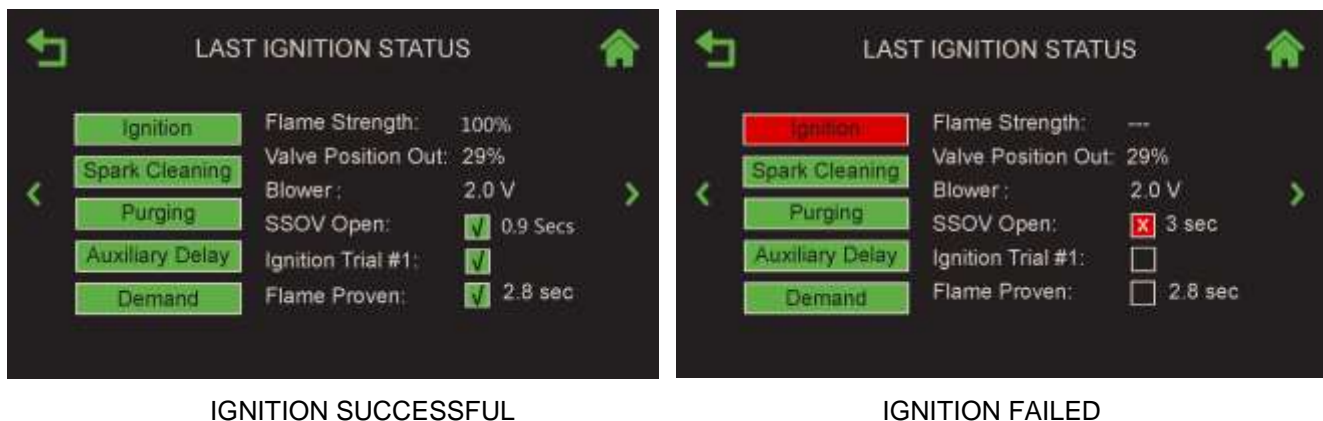


Event	Date/Time	Unit
Loss of Sensor	21-Jul, 1:45 PM	3
Flame Loss During Run	21-Jul, 11:53 AM	4
Airflow Fault During Purge	21-Jul, 8:21 AM	Plant
Loss of Sensor	21-Jul, 11:53 AM	3
Setpoint Limiting Active	20-Jul, 1:42 PM	3
Residual Flame	20-Jul, 7:37 AM	2
O2 Percentage Low	20-Jul, 6:58 AM	1
Low Water Level	19-Jul, 10:21 PM	3
Setpoint Limiting Active	17-Jul, 9:43 AM	3
Loss of Sensor	16-Jul, 7:42 PM	3

Figure 5.8: Plant Event History

## 5.9 Ignition Sequence Status

The **Last Ignition Status** screen displays a summary of the last ignition sequence, whether it is successful or not. If unsuccessful, it shows the step that failed in red, and one or more check boxes and the status box has red X.



IGNITION SUCCESSFUL

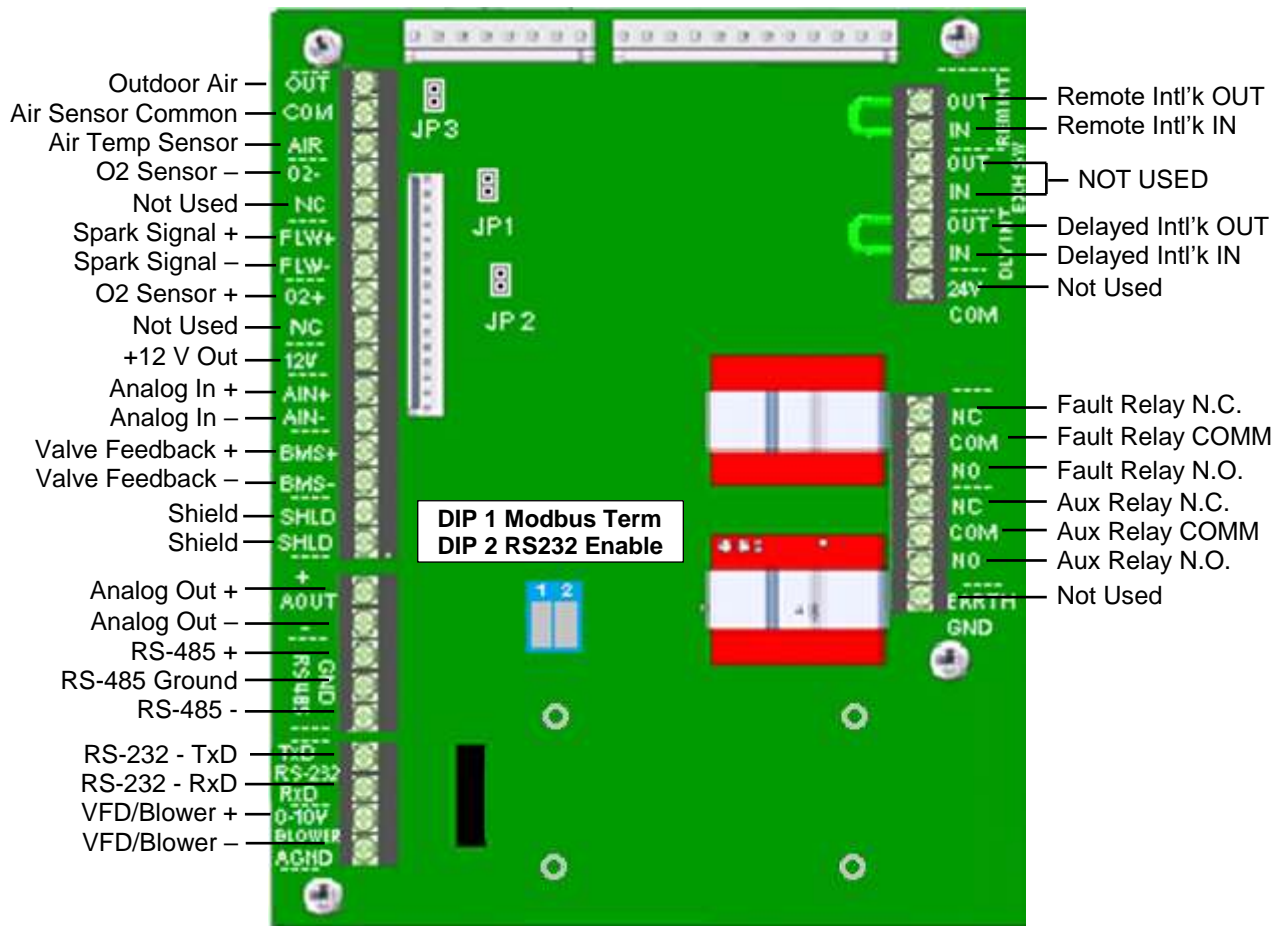
IGNITION FAILED

Figure 5.9: Ignition Screen



## SECTION 6: FIELD CONTROL WIRING

Each Innovation and Benchmark units with Edge [i] Controllers are fully wired at the factory with an internal operating control system. No field control wiring is required for normal operation. However, the Edge Controller used with all current generation Innovation Water Heaters and Benchmark Edge [i] Boilers does allow for some control and monitoring features. Wiring connections for these features are made in the Input/Output (I/O) Box.



**Figure 6.1: Edge [i] I/O Box Terminal Strips**

Since identical I/O Boxes are used with both Edge [i] versions of Benchmark Boilers and Innovation Water Heaters, some of the input and output connections apply only to boilers while others are common to both boilers and heaters. These I/O Box connections are described in the sections below.

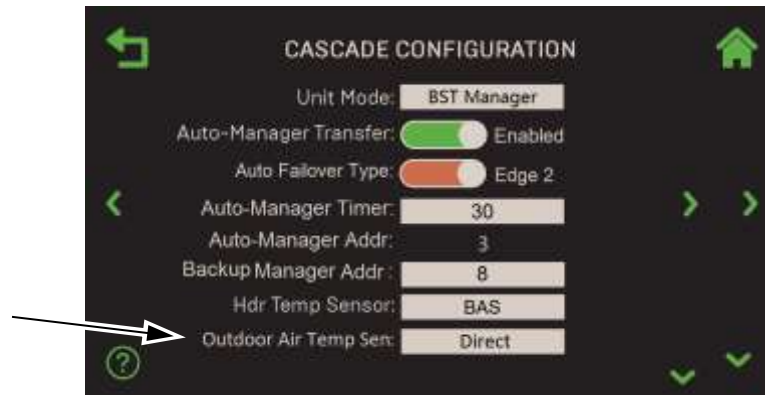
### 6.1 Outdoor Air & Air Sensor Common Terminals

The **Outdoor Air & Air Sensor Common** terminals are not used on Innovation Edge [i] units.

On Benchmark units, an outdoor temperature sensor (P/N 61047) is required for the **Outdoor Air Reset** operating mode. It can also be used with another mode if it is desired to use the outdoor sensor enable/disable feature, which allows the boiler to be enabled or disabled based on the outdoor air temperature.

The factory default for the outdoor air temp sensor is **OFF**. To enable the sensor, see the **Outdoor Air Temp Sens** parameter in the **Main Menu → Advanced Setup → BST Cascade → Cascade Configuration** menu, then choose the connection method:

- **Network:** If chosen, the **SH Sensor Comm Addr** parameter appears; specify the network address.
- **Direct**
- **BAS:** If chosen, the **SH Sensor Comm Addr** parameter appears; specify the network address.



**Figure 6-2: Cascade Configuration Screen**

The outdoor sensor may be wired **up to 200 feet (61m)** from the boiler. It is connected to the **OUTDOOR AIR** and **AIR SENSOR COMMON** terminals of the I/O board (see Figure 6-1). Wire the sensor using a twisted shielded pair wire from 18 to 22 AWG. There is no polarity to observe when terminating these wires. The shield is to be connected only to the terminals labeled **SHIELD** in the I/O Box PCB. The sensor end of the shield must be left free and ungrounded.

When mounting the sensor, it must be located on the North side of the building where an average outside air temperature is expected. The sensor must be shielded from direct sunlight as well as impingement by the elements. If a shield is used, it must allow for free air circulation.

## 6.2 Air Temp Sensor Terminal

The **Air Temp Sensor** terminal is not used on Innovation Edge [i] units.

On Benchmark units, the **Air Temp Sensor** terminal is used to monitor the air inlet temperature sensor (P/N 123449). This input is always enabled and is a “view only” input. It can be seen in the **BST Outdoor Temp** parameter in the **Main Menu → Advanced Setup → BST Cascade Configuration** menu. A resistance chart for this sensor is provided in Section 6 of the *Benchmark 750-6000 with Edge [i] Controller Reference Guide* (OMM-0146, GF-219). This sensor is an active part of the combustion control system and must be operational for accurate air/fuel mixing control.

## 6.3 O2 Sensor Terminals (+ & –)

The **O2 Sensor** terminals are not used on Innovation Edge [i] units.

On Benchmark units, the two **O2 Sensor** terminals are used to connect an integrated oxygen sensor to the I/O board. The O<sub>2</sub> concentration is displayed in the **Main Menu → Calibration →**

**Input/Output** → **O2 Sensor** menu after a 60 second warm-up period.



**Figure 6-3: O2 Sensor Screen**

## 6.4 Spark Signal Terminals (+ & –)

The **Spark Signal** terminals are used on both Benchmark Boilers and Innovation Water Heaters.

The **Spark Signal** terminals connect to the spark monitor (P/N **61034**, also called "AC Current transducer"), which monitors the current going to the ignition transformer (P/N **65085**). If the current is insufficient (too high or low) during the ignition sequence, the controller will abort the ignition cycle. The controller will attempt up to three ignition cycles. If the current is insufficient by the third try, the controller will shut down and display a fault message.

## 6.5 Analog In Terminals (+ & –)

The **Analog In** terminals are used on both Benchmark Boilers and Innovation Water Heaters.

The **Analog In** terminals (+ & -) are used when an external signal is used to change the unit's setpoint or air/fuel valve position. There are four signal types:

4 to 20 mA	1 to 5 VDC
0 to 20 mA	0 to 5 VDC

The factory default setting is **4 to 20 mA**, however this can be changed in the **Remote Signal** parameter in **Main Menu** → **Advanced Setup** → **Unit** → **Application Configuration** (note, **Operating Mode** must equal **Remote Setpoint**).

If voltage rather than current is selected as the drive signal, a DIP switch must be set on the Interface Board, located inside the Edge Controller. Refer to [Section 7: Edge \[i\] Controller Views](#) for information on setting DIP switches. If **Remote Signal** is set to either **4 to 20 mA** or **0 to 20 mA**, DIP switch #4 in block SW1 must be set to **mA**. If **Remote Signal** is set to **1 to 5 VDC** or **0 to 5 VDC**, DIP switch #4 must be set to **V**.

All supplied signals must be floating (ungrounded) signals. Connections between the source and the Heater's I/O Box must be made using twisted shielded pair of 18–22 AWG wire such as Belden 9841. Polarity must be maintained, and the shield must be connected only at the source end and must be left floating (not connected) at the unit's I/O Box.



Whether using voltage or current for the drive signal, they are linearly mapped to a 40°F (4.44 °C) to 240°F (115.6 °C) setpoint or a 0% to 100% air/fuel valve position. No scaling for these signals is provided.

## 6.6 Valve Feedback Terminals (+ & –)

The **Valve Feedback** terminals are used on Benchmark Boilers and Innovation Water Heaters.

The **Valve Feedback** terminals are used when the Sequencing Isolation Valve Feedback option is selected. The Valve Feedback signal is connected to the “Valve Fdbk” terminals and is used to confirm that the valve has properly opened or closed. If the Valve Feedback signal does not match the Valve-Open or Valve-Close command for the time defined in the "Valve Fdbk timer" entry, the controller will proceed as follows:

- (a) If the valve fails with the Valve Stuck Open fault, the **Valve Stuck Open** message will be displayed and the unit will remain active.
- (b) If the valve fails with the Valve Stuck Closed fault, the **Valve Stuck Closed** message will be displayed and the unit will shut down.

### NOTE:

If the Valve Feedback option is used, Shorting Jumper #JP2 on the I/O Board will be inserted at the factory.

## 6.7 Shield Terminals

The **Shield** terminals are used on Benchmark Boilers and Innovation Water Heaters.

The two **Shield** terminals are used to terminate any shields used on any sensor wires connected to the unit. Only shields must be connected to these terminals.

## 6.8 Analog Out Terminals (+ & –)

The **Analog Out** terminals are used on Benchmark Boilers and Innovation Water Heaters.

The two **Analog Out** terminals output from 0 to 20 mA and may be used to monitor Setpoint, Outlet Temperature, Valve Position 4-20 mA, Valve Position 0-10v or be set to OFF. The default setting in the Edge Controller is Valve Position **0-10 v** and settings behave as follows:

1. 0-10VDC **must** be selected for the voltage output used by the controller to modulate the combustion blower via the I/O Box terminals labeled **VFD/BLOWER** (Section 6.11).
2. If Boiler Sequencing Technology (BST) or Water Heater Management (WHM) is enabled, the Analog Output terminals are used to open and close the isolation valve. On Benchmark units, a 0-20 mA signal is used: 20 mA = closed, 0 mA = open.

### NOTE:

When driving an isolation valve, shorting jumper #JP2 **MUST** be installed on the I/O Board.

On older legacy Benchmark units, the two ANALOG OUT terminals may be used to monitor Setpoint, Outlet Temperature, Valve Position 4-20 mA, Valve Position 0-10v or be set to OFF.

## 6.9 RS485 Comm Terminals (+, Ground, –)

The **RS485 Comm** terminals are used on Benchmark Boilers and Innovation Water Heaters.

On Innovation Water Heaters, the three **RS485 Comm** terminals are used when the Innovation Water Heaters are being controlled by an Energy Management System (EMS) or the Edge Controller's Water Heater Management (WHM) system using Modbus (RS485) communication. The WHM software required to control up to 8 AERCO Innovation Water Heaters is included in the Edge Control System used with each Innovation unit.

On Benchmark Boilers, the three **RS-485** communication terminals are used when the boiler plant is being controlled by an Energy Management System (EMS) or an AERCO Control System (ACS) using Modbus (RS485) communication

## 6.10 RS232 Comm Terminals (TxD & RxD)

On both Benchmark Boilers and Innovation Water Heaters, as of Firmware version 4.0 and above, these terminals are used only by factory-trained personnel to monitor OnAER communications via a portable computer.

## 6.11 VFD/BLOWER Terminals (0-10 & AGND)

The **VFD/Blower** terminals are used on Benchmark Boilers and Innovation Water Heaters.

The **VFD/Blower** terminals send an analog signal to control the blower speed. When any of the 4-20 mA options is selected for the Analog Outputs (Section 6.8), the output from the VFD/Blower terminals is disabled.

## 6.12 Remote Interlock Terminals

The **Remote Interlock** terminals are used on Benchmark Boilers and Innovation Water Heaters.

The unit offers two interlock circuits for interfacing with Energy Management Systems and auxiliary equipment such as pumps or louvers or other accessories. These interlocks are called the **Remote Interlock** and **Delayed Interlock (Remote Intl'k In** and **Delayed Intl'k In** in Figure 6.1). Both interlocks, described below, are factory wired in the closed position using jumpers.

### NOTE:

Both the Remote Interlock and Delayed Interlock must be in the closed position for the unit to fire.

### 6.12.1 Remote Intl'k Terminals

The remote interlock circuit is provided to remotely start (enable) and stop (disable) the unit if desired. The circuit is 24 VAC and comes factory pre-wired closed (jumped).

### 6.12.2 Delayed Intl'k Terminals – Innovation Water Heaters

On Innovation Water heaters, the delayed interlock is typically used in conjunction with the three **Aux Relay** contacts described in Section 6.14. This interlock circuit is located in the purge section of the start string. It can be connected to the proving device (end switch, flow switch etc.) of an auxiliary piece of equipment started by the unit's auxiliary relay. The delayed interlock must be closed for the heater to fire. If the delayed interlock is connected to a proving device that requires time to close (make), a time delay (**Auxiliary Delay**) that holds the start sequence of the unit long enough for a proving switch to make (close) can be programmed.

Should the proving switch not prove within the programmed time frame, the unit will shut down. The **Auxiliary Delay** parameter (in [Main Menu](#) → [Advanced Setup](#) → [Ancillary Device](#) → [Interlocks](#)) can be programmed from 0 to 240 seconds.

### 6.12.2.1 DELAYED INTL'K Terminals – Benchmark Boilers

On Benchmark Boilers, the **Delayed Interlock** terminals can be used in one of two ways:

- In conjunction with the optional external sequencing valve, a component of AERCO's on-board Boiler Sequencing Technology (BST) solution (see section 2.14: *Sequencing Isolation Valve Installation* and Section 7: *Boiler Sequencing Technology* in the *Benchmark 750-6000 with Edge [i] Controller Operation Guide* (OMM-0145). A cable from the boiler's wiring harness is connected to these terminals on all units; if BST is implemented, the other end of that cable is connected to the sequencing valve.
- If BST is *NOT* implemented, the second use is typically in conjunction with the three **Aux Relay** contacts described in Section 6.14, below. This interlock circuit is located in the purge section of the start string. It can be connected to the proving device (end switch, flow switch etc.) of an auxiliary piece of equipment started by the unit's auxiliary relay. If the delayed interlock is connected to a proving device that requires time to close (make), a time delay (AUX START ON DLY) that holds the start sequence of the unit long enough for a proving switch to make (close) can be programmed.

To use this option, you must disconnect the harness from the Delayed Interlock terminals and connect the proving device in its place.

Should the proving switch not prove within the programmed time frame, the unit will shut down. The **Auxiliary Delay** parameter can be programmed from 0 to 240 seconds (go to: [Main Menu](#) → [Advanced Setup](#) → [Ancillary Device](#) → [Interlocks](#)).

## 6.13 Fault Relay Terminals (N.C., COM, & N.O.)

The **Fault Relay** terminals are used on Benchmark Boilers and Innovation Water Heaters.

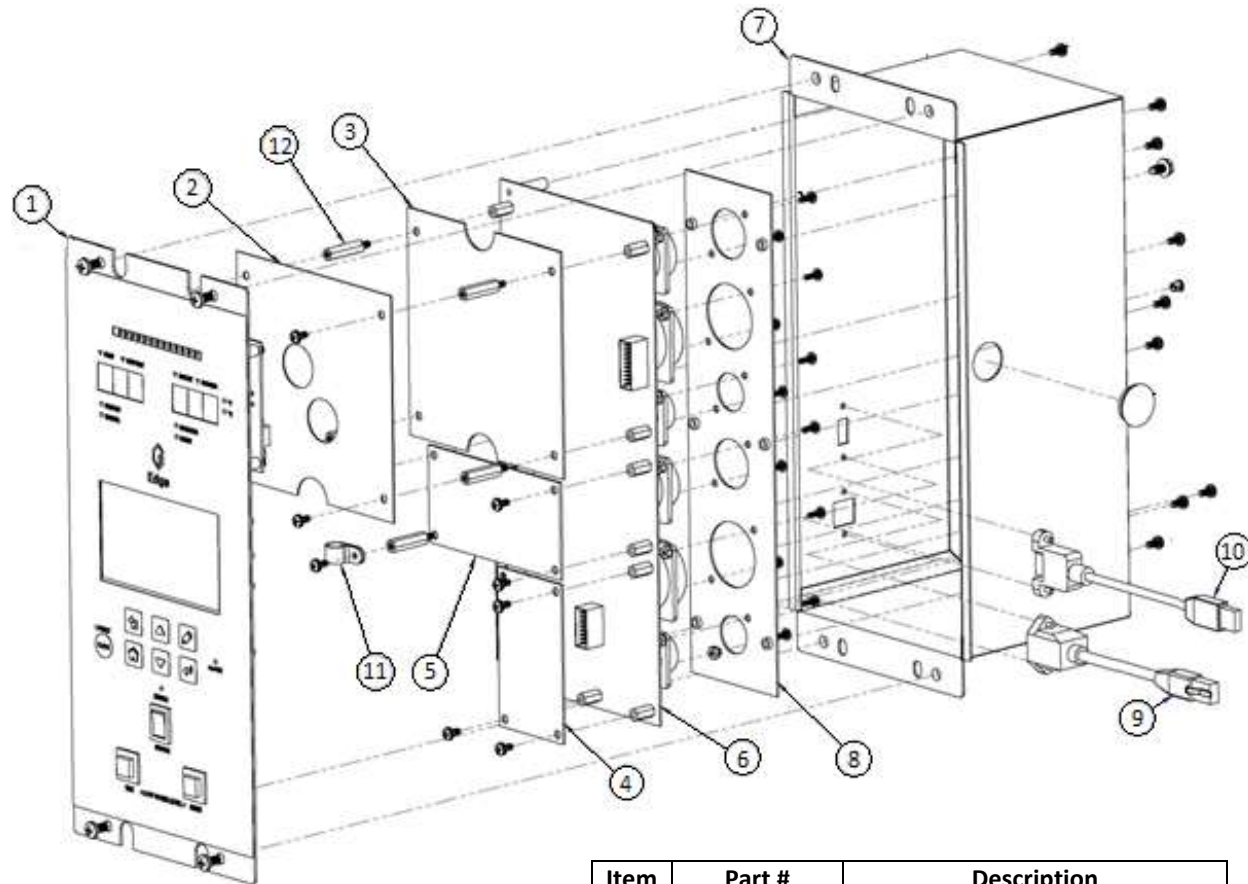
The fault relay is a single pole double throw (SPDT) relay having a normally open and normally closed set of relay contacts that are rated for 5 amps at 120 VAC and 5 amps at 30 VDC. The relay energizes when any fault condition occurs and remains energized until the fault is cleared and the **CLEAR** button is depressed.

## 6.14 Aux Relay Terminals (N.C., COM, & N.O.)

The **Aux Relay** terminals are used on Benchmark Boilers and Innovation Water Heaters.

Each unit is equipped with a single pole double throw (SPDT) auxiliary relay that is energized when there is a demand for heat and de-energized after the demand for heat is satisfied. The relay is provided for the control of auxiliary equipment, such as pumps and louvers, or can be used as a unit status indicator (firing or not firing). Its contacts are rated for 120 VAC @ 5 amps.

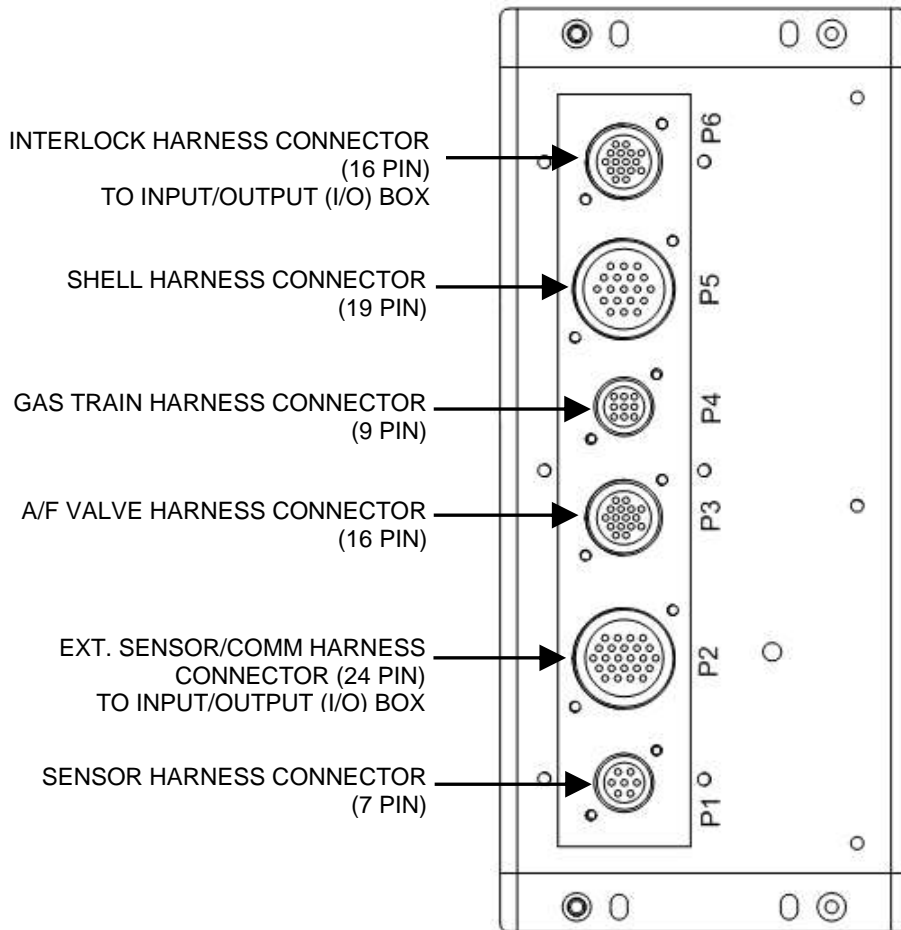
# SECTION 7: EDGE [i] CONTROLLER VIEWS



Item	Part #	Description
1	69333-TAB	Control Panel Front Assembly
2	124960	Fish Paper, IGST
3	124361	IGST Board
4	124363	Low Water Cut Off Board
5	124362	Power Supply
6	64139	Connector Board
7	37142	Control Box Enclosure
8	38045	Connector Plate
9	62085	Panel Mount Ethernet Extension
10	62084	Panel Mount USB Cable
11	124962	Cable Clamp
12	59249	Hex Standoff

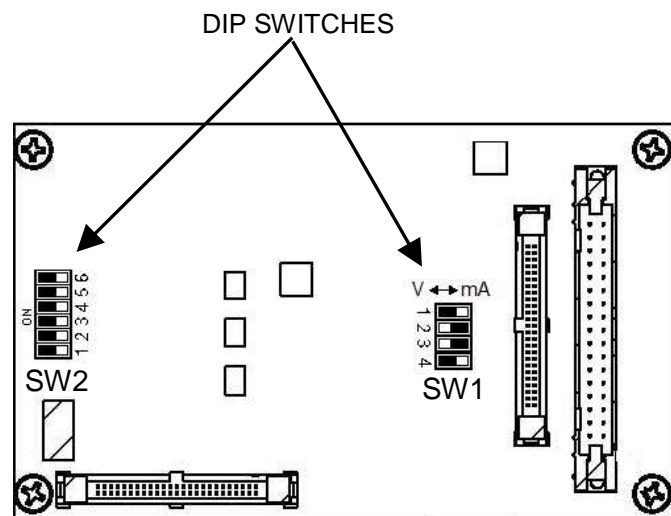
**Figure 7-1 – Edge [i] Controller (P/N 64134) - Exploded View**

SECTION 7 – EDGE [i] CONTROLLER VIEWS



**Figure 7-2: Edge [i] Controller Rear View**

DIP Switch Function & Default			
SW2		SW1	
Switch	Default	Switch	Default
1 Bias +	OFF	1 CO Sensor	mA
2 Termination	OFF	2 Flow Sensor	V
3 Bias –	OFF	3 O <sub>2</sub> Sensor	V
4 Not Used		4 Analog In	mA
5 Not Used			
6 Not Used			



**Figure 7-3: Edge [i] Controller Interface Board (the back side of the front face)**

## SECTION 8: STARTUP, STATUS, FAULT MESSAGES

The Edge Controller displays status messages at various times showing the current state of the Edge Controller. All status messages are displayed near the top of the touchscreen in **WHITE** text, just under the current screen's title.

### 8.1 FAULT MESSAGES

The Edge [i] Controller displays the following messages when appropriate. The # column lists the corresponding code returned to Building Automation Systems.

Four types of messages can appear on the Edge Controller's display screen:

- **Message:** Information about a current event or condition: no intervention required.
- **Warning:** An abnormal event or condition occurred, but the unit continues to operate normally: no intervention required.
- **Fault:** An abnormal event or condition occurred that caused the unit to shut down. The unit will restart automatically once the cause of the fault is resolved.
- **Fault, Manual Reset:** An abnormal event or condition occurred that caused the unit to shut down. A corrective action may be required. Once the cause of the fault is resolved, the Controller's **CLEAR** button must be pressed manually to restart the unit.

#	FAULT MESSAGE	DESCRIPTION	TYPE
0	NO FAULTS		
1	Disabled	Indicates the <b>Enable/Disable</b> switch is set to <b>Disabled</b> . The display also shows the time (AM or PM) and date that the unit was disabled.	Message
2	Standby	Displayed when ON/OFF switch is in the <b>ON</b> position, but there is no demand for heat. The time and date are also displayed.	Message
3	Demand Delay	Demand Delay is active.	Message
4	Purging	The duration of the purge cycle during startup, in seconds.	Message
5	Ignition Trial	Displayed during ignition trial startup sequence. The duration of cycle counts up in seconds.	Message
6	Flame Proven	Displayed after flame has been detected for a period of 2 seconds. Initially, the flame strength is shown in %. After 5 seconds has elapsed, the time and date are shown in place of flame strength.	Message
7	Warmup	Displayed for 2 minutes during the initial warm-up only.	Message
8	High Water Temp Switch Open	The High-Water Temperature Limit switch is open.	Fault, Manual Reset
9	Low Water Level	The Low Water Cutoff board is indicating low water level.	Fault, Manual Reset
10	Low Gas Pressure Fault	The Low Gas Pressure Limit switch is open	Fault, Manual Reset
11	Gas Pressure Fault	The Gas Pressure Limit switch is not connected or malfunctioned	Fault, Manual Reset



## SECTION 8 – STARTUP, STATUS, FAULT MESSAGES

TABLE 8-1: Edge Controller Fault Messages			
#	FAULT MESSAGE	DESCRIPTION	TYPE
12	Interlock Open	The Remote Interlock is open.	Fault, Manual Reset
13	Delayed Interlock Open	The Delayed Interlock is open.	Fault, Manual Reset
14	Airflow Fault During Purge	The Blower Proof switch opened during purge, or air inlet is blocked.	Fault, Manual Reset
15	SSOV Fault During Purge	The SSOV switch opened during purge.	Fault, Manual Reset
16	Prg Switch Open During Purge	The Purge Position Limit switch on the Air/Fuel Valve was open during purge.	Fault, Manual Reset
17	Ign Switch Open During Ignition	The Ignition Position Limit switch on the Air/Fuel Valve opened during ignition.	Fault, Manual Reset
18	Airflow Fault During Ign	The Blower Proof switch opened during ignition.	Fault
19	Airflow Fault During Run	The Blower Proof switch opened during run.	Fault, Manual Reset
20	SSOV Fault During Ignition	The SSOV switch closed or failed to open during ignition.	Fault, Manual Reset
21	SSOV Fault During Run	The SSOV switch closed for more than 15 seconds during run.	Fault, Manual Reset
22	Flame Loss During Ignition	The Flame signal was not seen during ignition or lost within 5 seconds after ignition.	Fault, Manual Reset
23	Flame Loss During Run	The Flame signal was lost during run.	Fault, Manual Reset
24	High Exhaust Temp Switch	The High Exhaust Temp switch is open.	Fault, Manual Reset
25	Loss of Power	The unit shut down due to loss of power	Fault
26	Loss of Sensor	Not used	Not used
27	Loss of Signal	Not used	Not used
28	High O <sub>2</sub> Level	The O <sub>2</sub> Sensor reading is <u>above</u> acceptable level.	Fault
29	Low O <sub>2</sub> Level	The O <sub>2</sub> Sensor reading is <u>below</u> acceptable level.	Fault
30	High CO Level	Not used	Not used
31	SSOV Relay Failure	A failure has been detected in one of the relays that control the SSOV.	Fault, Manual Reset
32	Residual Flame	The Flame signal was seen for more than 60 seconds during standby.	Fault, Manual Reset
33	Heat Demand Failure	The unit failed to fulfill the demand for heat.	Fault, Manual Reset
34	Ign Switch Closed During Purge	The Ignition Position Limit switch on the Air/Fuel Valve closed during purge.	Fault, Manual Reset
35	Prg Switch Closed During Ign	The Purge Position Limit switch on the Air/Fuel Valve was stuck closed during ignition.	Fault, Manual Reset
36	SSOV Switch Open	The SSOV switch opened during standby.	Fault, Manual Reset
37	Ign Board Comm Fault	A communication fault has occurred between the PMC board and Ignition board.	Fault
38	Wait	The unit is waiting for a process to run to completion.	Message
39	Direct Drive Signal Fault	The direct drive signal is not present or is out of range.	Fault



## SECTION 8 – STARTUP, STATUS, FAULT MESSAGES

TABLE 8-1: Edge Controller Fault Messages			
#	FAULT MESSAGE	DESCRIPTION	TYPE
40	Remote Setpt Signal Fault	The Remote Setpoint signal is not present or is out of range.	Fault
41	Outdoor Temp Sensor Fault	The temperature measured by the Outdoor Air Sensor is out of range.	Fault
42	Outlet Temp Sensor Fault	The temperature measured by the Outlet Sensor is out of range: <ul style="list-style-type: none"> <li>OUTLET TEMPERATURE display = Sht Indicates sensor is shorted</li> <li>OUTLET TEMPERATURE display = Opn indicates sensor is open-circuited</li> </ul>	Fault
43	FFWD Temp Sensor Fault	The temperature measured by the Feed Forward (FFWD) Sensor is out of range.	Fault
44	High Water Temp	The temperature measured by the Outlet Sensor exceeded the Temp Hi Limit setting.	Fault
45	Line Voltage Out of Phase	The Line (Hot) and Neutral wires are reversed.	Fault, Manual Reset
46	Stepper Motor Failure	The Stepper Motor failed to move the Air/Fuel Valve to the desired position.	Fault, Manual Reset
47	Setpoint Limiting Active	Outlet temperature crossed the high setpoint limit. Setpoint limiting feature is active.	Fault
48	Modbus Comm Fault	A network communication fault	Fault
49	Wait Ignition Retry	The unit is waiting before retrying to ignite.	Message
50	WaitFault Purge	Fault while purging.	Message
51	Wait Retry Pause	Pause before retrial for ignition.	Message
52	Exhaust Temp Sensor Short	The Exhaust Temp Sensor has malfunctioned.	Warning
53	Exhaust Temp Sensor Open	Exhaust Temp Sensor is not connected or malfunctioned.	Warning
54	Warning Exhaust Temp High	The Exhaust temperature is above normal.	Warning
55	Exhaust Temp High	The Exhaust Temperature has exceeded 200°F (93.3°C).	Fault, Manual Reset
56	Inlet Water Temp Sensor Short	Inlet Water Temp Sensor has malfunctioned/shorted out.	Warning
57	Inlet Water Temp Sensor Open	Inlet Water Temp Sensor is not connected or malfunctioned.	Warning
58	Warning In Wtr Temp High	Warning: Inlet water temperature is above normal.	Warning
59	Warning In Wtr Temp Low	Warning: Inlet water temperature is below normal.	Warning
60	Inlet Gas Press Sensor Open	Inlet Gas Pressure Sensor is not connected or malfunctioned.	Fault
61	Gas Plate Dp Sensor Open	Gas Plate Dp Sensor is not connected or malfunctioned.	Fault
62	O2 Percentage Low	The O <sub>2</sub> % has gone below 2% for more than 30 seconds	Fault
63	O2 Sensor Malfunction	Indicates O <sub>2</sub> Levels are less than -4% or more than 24% for more than 10 seconds.	Fault
64	Warning O2 Level High	The O <sub>2</sub> is above normal operating limits.	Warning
65	Recirc Pump Failure	The recirculation pump has failed.	Fault, Manual Reset

## SECTION 8 – STARTUP, STATUS, FAULT MESSAGES

TABLE 8-1: Edge Controller Fault Messages			
#	FAULT MESSAGE	DESCRIPTION	TYPE
66	Ignition Monitor	The ignition spark monitor indicated no or out of range spark.	Message
67	No Flow Safety Lockout	Not used	Not Used
68	Ignition Spark Fault	The O <sub>2</sub> is above normal operating limits.	Fault, Manual Reset
69	Pre Ignition	The recirculation pump has failed.	Message
70	Cleaning Igniter	Displayed during ignition sequence during the Spark Cleaning cycle.	Message
71	Too Many Cycles In 24 Hours	The number of cycles experienced by the unit exceeded the allowable limit.	Fault
72	Too Many Ovrtrmps In 24 Hours	The number of over-temperature events exceeded the allowable limit.	Fault
73	Air Sensor Fault	The Air Temp sensor has malfunctioned.	Fault
74	Auto Diagnostic Mode ACTIVE	The unit is in Auto Diagnostic Mode	Message
75	Auto Diagnostic Mode COMPLETED	Auto Diagnostic Mode has completed	Message
76	Auto Diagnostic Mode ABORTED	Auto Diagnostic Mode has aborted	Message
77	DHW Heating Active	The unit is actively heating domestic hot water.	Message
78	Boiler Cooling Off	The unit has ceased firing and is now cooling down.	Message
79	BST Network Temp Sensor Fault	BST network temp sensor fault.	Fault
80	BST Network Temp Com Fault	BST network temp communication fault.	Fault
81	BST Local Header Sensor Fault	BST local header sensor fault.	Fault
82	BST Net Outdoor Sensor Fault	BST net outdoor sensor fault.	Fault
83	BST Net Outdoor Com Fault	BST net outdoor communication fault.	Fault
84	BST Local Outdr Sensor Fault	BST local outdoor sensor fault.	Fault
85	BST Client Com Fault	Communication with a BST Client unit failed.	Message
86	O <sub>2</sub> Cal Purge	O <sub>2</sub> calibration is in purge cycle.	Message
87	Auto Calibration In Progress	O <sub>2</sub> calibration is underway.	Message
88	Autocal Finished	O <sub>2</sub> calibration is complete.	Warning
89	O <sub>2</sub> Sensor Out Of Range	O <sub>2</sub> sensor failed during O <sub>2</sub> calibration.	Warning
90	O <sub>2</sub> Warning Service Required	AERtrim has reached its limit and O <sub>2</sub> level is still out of range.	Message
91	Wait Sensor Warm-up	The unit is waiting for the O <sub>2</sub> sensor to turn on.	Warning
92	Air Pump Failed O <sub>2</sub> Trim Disabled	Air Aductor pump failed, disabling O <sub>2</sub> trim functionality (BMK5000-6000 only)	Fault
93	onAER Communication failed	onAER communication failed. No internet connection.	Warning
94	Isolation Valve Stuck Open	The isolation valve failed to <u>close</u> as expected.	Warning
95	Isolation Valve Stuck Closed	The isolation valve failed to <u>open</u> as expected.	Fault
96	Maintenance Overdue	Scheduled 12- or 24-month maintenance is overdue.	Warning
97	Maintenance Due Soon	Scheduled 12- or 24-month maintenance is due in near future.	Warning
98	BAS System Disable	Unit is shut down remotely via BAS	Warning

#	FAULT MESSAGE	DESCRIPTION	TYPE
99	Delta-T Activated	Delta-T temperature is out of user defined delta limit.	Warning
100	Delta-T Shutdown	The unit shut down due to exceeding allowable Delta-T value.	Warning
101	BackUp Manager is not Compatible	The unit designated as the Backup Manager is not compatible with Manager functionality.	Warning
102	IO Board Communication Failed	I/O board communication has failed.	Warning
103	SH Swing Valve Fault	Space Heating side swing valve failed	Warning
104	DHW Swing Valve Fault	Domestic hot water side swing valve failed	Warning
105	No BAS Communication	No communication from the Building Automation system	Warning
106	BST Warm Weather Shutdown	BST warm weather shutdown warning	Warning
107	Warm Weather Shutdown	Standalone warm weather shutdown warning	Warning
108	DHW Header Temp BAS Comm Fault	BAS failed to update the DHW temperature periodically	Warning
109	BST Header Temp BAS Comm Fault	BAS failed to update the BST header temperature periodically	Warning
110	Supply Return Temp BAS Comm Fault	BAS failed to update the supply return temperature periodically	Warning
111	Outdoor Temp BAS Comm Fault	BAS failed to update the outdoor temperature periodically	Warning
112	BST Return Sensor Short Warning	BST return sensor is shorted. Check the wirings.	Warning
113	BST Return Sensor Open Warning	BST return sensor is disconnected	Warning
114	DHW Header Network Sensor Fault	DHW header network sensor temperature is out of range.	Warning
115	DHW Header Network Comm Fault	No communication response from the DHW header network sensor	Warning
116	Supply Return Network Sensor Fault	Supply Return Network Sensor temperature is out of range.	Warning
117	Supply Return Network Comm Fault	No communication response from the supply return network sensor	Warning

## 8.2 WHM and BST CASCADE MESSAGES

On Innovation Water Heaters, the Edge [i] Controller displays the following messages related to Water Heater Management (WHM):

MESSAGE	Type
All Heaters Off	Status
All Heaters On	Status
Enabling First	Status
Enabling Next	Status
Water Heater Inactive	Status
Water Heater Active	Status
Remote Signal Fault	Fault

## SECTION 8 – STARTUP, STATUS, FAULT MESSAGES

<b>TABLE 8-3: Edge Controller WHM Cascade Messages</b>	
<b>MESSAGE</b>	<b>Type</b>
WHMS Failsafe	Status

On Benchmark Boilers, the Edge [i] Controller displays the following messages related to Boiler Sequencing Technology (BST):

<b>TABLE 8-4: Edge Controller BST Cascade Messages</b>	
<b>MESSAGE</b>	<b>Type</b>
All Boilers Off	Status
All On > 90% Fire Rate	Warning
All On-Raise Fire Rate	Status
Auto Cycling On	Status
Boiler Ignited	Status
WHM Client Com Fault	Warning
BST FAILSAFE	Warning
BST in Control	Status
BST in Deadband	Status
BST Overtemp	Fault
Failsafe Active	Status
Igniting First	Status
Igniting Next Boiler	Status
Lower Fire Rate	Status
On Temperature	Status
One Boiler Mode	Status
Raise Fire Rate	Status
Remote Sig Fault	Fault

**NOTES:**

---

**Change Log:**

Date	Description	Changed By
8/25/2020	<b>Rev D:</b> <b>DIR 20-14:</b> Revised Section 4.2.7: <i>Firmware Update</i> to account for Intelligent Bootloader changes. Changed Controller Front Panel P/N from 69294 to 69333-TAB, Figure 7-1. Added graphic of the A/F Valve, Section 2.3.1: <i>Air/Fuel Valve Calibration</i> . Removed GF-213-B from this document's file name. Added additional fault message types, Section 8.1	Chris Blair
3/25/2021	<b>Rev E:</b> Revised Section 6, renamed it to <i>Field Control Wiring</i> .	Chris Blair



© AERCO International, Inc., 2021