

User Guide & Instruction Manual

ADMS

Smart Water Tempering System

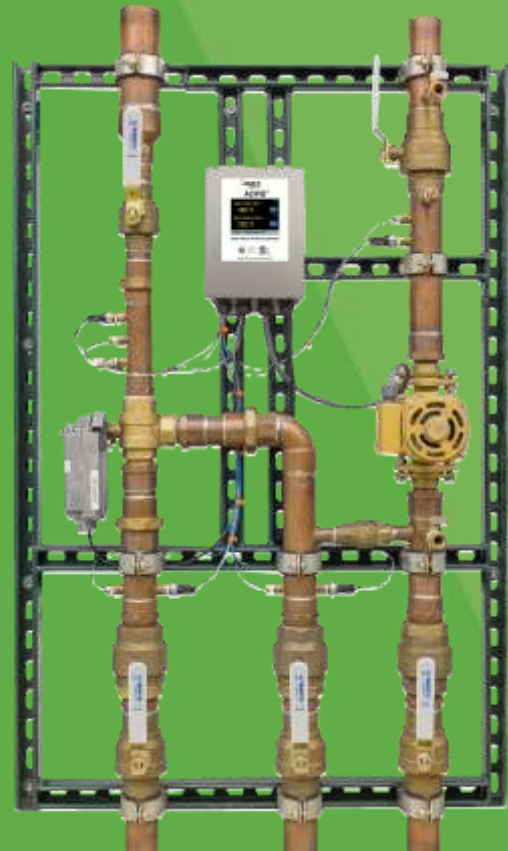

Disclaimer

The information contained in this manual is subject to change without notice from AERCO International, Inc. AERCO makes no warranty of any kind with respect to this material, including, but not limited to, implied warranties of merchantability and fitness for a particular application. Some states do not allow the exclusion or limitation of incidental or consequential damages, so the above limitation may not apply. AERCO is not liable for errors appearing in this manual, not for incidental or consequential damages occurring in connection with the furnishing, performance, or use of these materials.

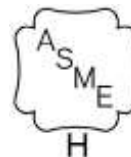

Heating and Hot Water Solutions

AERCO International, Inc. • 100 Oritani Drive • Blauvelt, NY 10913
USA: T: (845) 580-8000 • Toll Free: (800) 526-0288 • AERCO.com
Technical Support • (800) 526-0288 • Mon-Fri, 8 am - 5 pm EST
© 2023 AERCO

Table of Contents

SECTION 2.	SAFETY INFORMATION.....	3
SECTION 3.	ADMS DESCRIPTION AND SPECIFICATIONS	4
SECTION 4.	DESCRIPTION OF CONTROLS AND FUNCTIONS.....	9
SECTION 5.	SET UP AND PROGRAMMING	21
SECTION 7.	SANITIZATION	31
SECTION 8.	AERCO ADMS BAS INTEGRATION MANUAL.....	37
SECTION 9.	TROUBLESHOOTING.....	52
SECTION 10.	SCHEDULED TESTING, INSPECTION, & MAINTENANCE	63

SAFETY INFORMATION

- Read the Manual and all product labels and follow all safety and other information.

- Replacement Manuals available at aerco.com

Understanding Safety Information



This safety-alert symbol is shown alone or used with a signal word (DANGER, WARNING, or CAUTION), a pictorial and/or a safety message to identify hazards and alert you to the potential for death or serious personal injury.



This pictorial alerts you to the need to read the manual.



This pictorial alerts you to scalding, burn and hot water hazards.



Identifies hazards which, if not avoided, will result in death or serious injury.



This pictorial alerts you to burn and hot surfaces hazards.



Identifies hazards which, if not avoided, could result in death or serious injury.



This pictorial alerts you to electricity, electrocution, and shock hazards.



Identifies hazards which, if not avoided, could result in minor or moderate injury.



This pictorial alerts you to the need to perform appropriate Lock Out/ Tag Out procedures.



Identifies practices, actions, or failure to act which could result in property damage or damage to the equipment.

ADMS Description and Specifications

The ADMS is electronic water mixing system providing user-directed control and monitoring of water distribution systems. ADMS includes an electronic Control Module featuring a color touchscreen digital display to select desired outlet water temperature, an electronically actuated valve that mixes hot water with cold water, temperature sensors (plus a quick response temperature sensor), pressure sensors, check valves, and a recirculation pump to maintain the recirculation loop temperature (reducing wait time for tempered water to reach point-of-use fixtures, saving water and energy). The ADMS monitors hot supply inlet temperature, hot supply pressure, mixed outlet temperature, mixed outlet pressure, mixed outlet flow rate (optional), return temperature, and return pressure, to help maintain the desired outlet water temperature. ADMS also features a user programmable high temperature Sanitization mode to help limit water-borne bacteria as part of a user-directed and controlled thermal eradication protocol.

The ADMS Control Module supports building automation systems (BAS) communication with BACnet® IP, BACnet® MSTP, and Modbus® protocols, allowing remote programming and data viewing.

Installation and adjustment of the ADMS are the responsibility of the owner and installer and must be done by qualified personnel in accordance with the manufacturer's instructions, and complying with all governmental requirements, building and construction codes and standards. It is recommended to install ADMS as part of an ASSE compliant water distribution system, including mixing valves and/or temperature limiting devices at all point-of-use fixtures (faucets, sinks, tubs, showers, etc.) that are approved to ASSE 1016, 1069, 1070 and 1071. The owner and user of the ADMS is responsible for selecting and installing the product in an appropriate water distribution system, proper sizing, maintaining proper water quality/condition, and deciding what temperature is safe and appropriate for the water distribution users and facility.

ADMS Description and Specifications

The ADMS components are shown below:

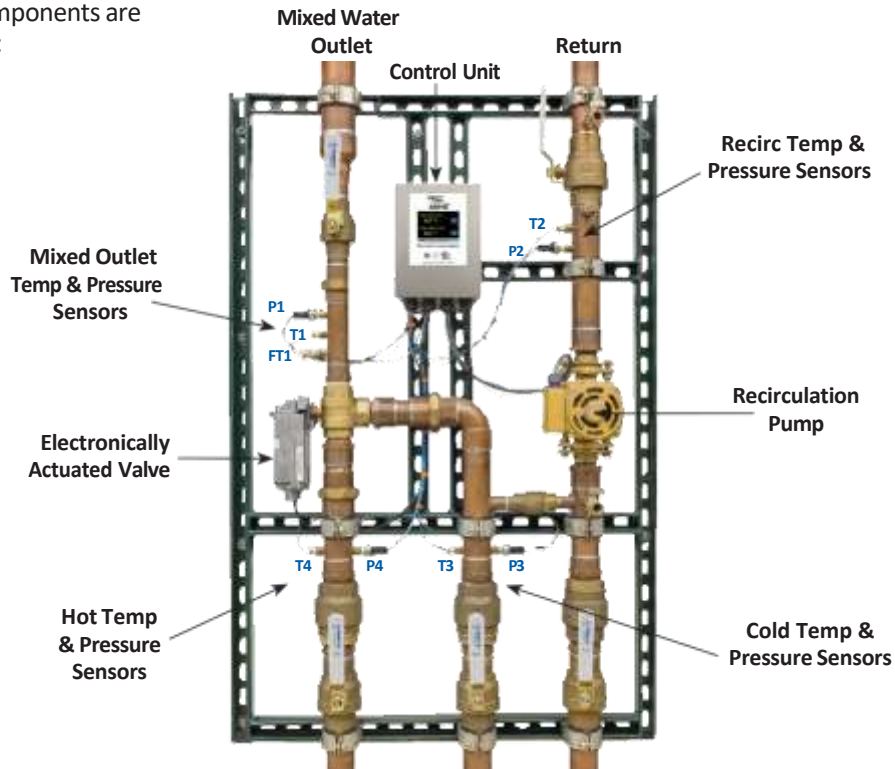

ADMS150

Dimensions

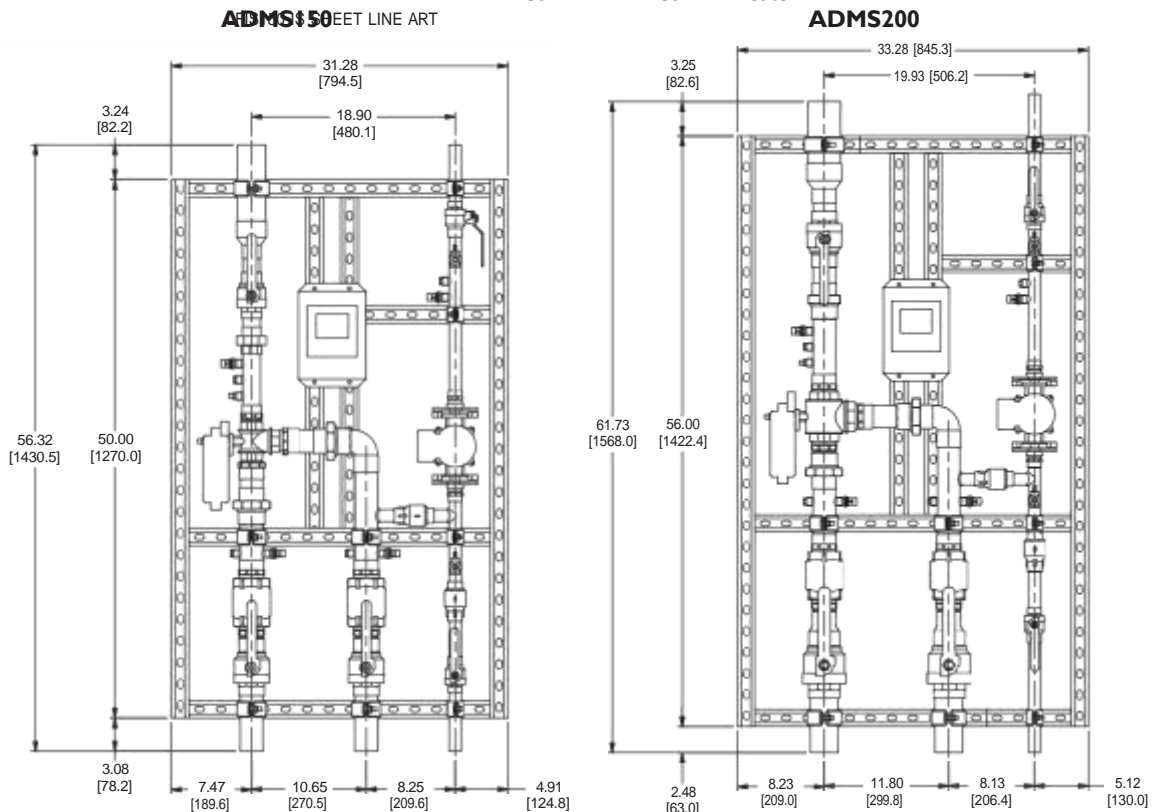

Dimensions are shown $\pm 1/2''$
Dimensions in parentheses are in mm

ADMS Description and Specifications

Specifications ■

Maximum Operating Pressure 200psi (1379 kPa)
 Maximum Hot Water Temperature 200°F (93°C)
 Minimum Hot Water Supply Temp. ** 2°F (1°C) Above Set Point
 Hot Water Inlet Temperature Range 120 – 180°F (49-82°C)
 Cold Water Inlet Temperature Range 39 – 80°F (4-27°C)
 Minimum Flow*** 0.5 gpm (1.89 lpm)
 Outlet Water Temperature Adjustment Range**** 80 – 180°F (27-82°C)
 Listing/Compliance..... ASSE1017®, cUPC®, NSF®, CSA 24/UL873

* The wetted surface of this product contacted by consumable water contains less than 0.25% of lead by weight.

** With Equal Pressure

*** Minimum flow when ADMS is installed at or near hot water source recirculating tempered water with a properly sized continuously operating recirculating pump.

**** Low limit cannot be less than the cold water temperature. For best operation, hot water should be at least 5°F (3°C) above desired set point.

^ Listed without re-circulation line & pump



User is responsible for determining safe and appropriate temperatures and pressures for system users, guests and facility.

Technical Specifications ■

Input Power 115 V ±10%, 60 Hz, 30 VA, 1180 VA fully loaded
 Pump relay..... 115/230 V: 10/8 FLA, 50/48 LRA Motor Load
 Alert relay: 30 V (ac/dc) max. 2 A, resistive, Class 2
 5 V capacity:..... 10 mA maximum each, resistive, Class 2
 20 V capacity:..... 20 mA maximum each, resistive, Class 2
 Actuator load:..... 20 VA
 Meets Class B:..... CES and FCC Part 15

Capacity ■

Flow Capacity								
Pressure Drop Across Valve								
Model	Min. System Draw*	C _v	5psi (34 kPa)	10psi (69 kPa)	20psi (138 kPa)	30psi (207 kPa)	45psi (310 kPa)	50psi (345 kPa)
ADMS150	0.50	26.88	60 gpm 227 lpm	85 gpm 322 lpm	120 gpm 454 lpm	147 gpm 556 lpm	180gpm 681 lpm	190 gpm 719 lpm
ADMS200	0.50	42.70	96 gpm 363 lpm	135 gpm 511 lpm	191 gpm 723 lpm	234 gpm 886 lpm	286 gpm 1083 lpm	302 gpm 1143 lpm
ADMS150D	0.50	53.57	120 gpm 454 lpm	170 gpm 644 lpm	240 gpm 908 lpm	294 gpm 1113 lpm	360 gpm 1363 lpm	380 gpm 1439 lpm
ADMS200D	0.50	85.27	192 gpm 727 lpm	270 gpm 1022 lpm	382 gpm 1446 lpm	468 gpm 1772 lpm	572 gpm 2165 lpm	604 gpm 2286 lpm
ADMS200T	0.50	127.90	288 gpm 1090 lpm	405 gpm 1533 lpm	573 gpm 2169 lpm	702 gpm 2657 lpm	858 gpm 3248 lpm	906 gpm 3430 lpm

*With a properly sized pump

Installation

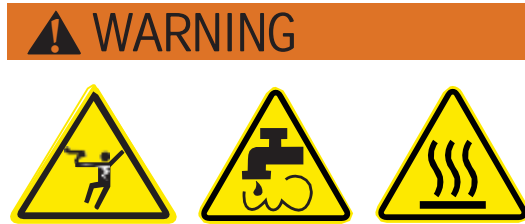

Failure to follow all installation requirements risks possible death, personal injury, property damage, and failure of the ADMS to perform as intended.

- Installation of ADMS MUST be performed by qualified technicians, including licensed electricians and plumbers, following all manufacturer's instructions, complying with all local, state, federal and other governmental requirements, and with all building and construction codes and standards.
- Use ONLY with a potable water distribution system free of debris, foreign materials, corrosive chemicals or substances, and other adverse conditions.
- ADMS is recommended for use as part of an ASSE compliant water distribution system, including mixing valves and/or temperature limiting devices at all point-of-use fixtures (faucets, sinks, tubs, showers, etc.).
- ADMS MUST be installed in a dry area not susceptible to freezing.
- Keep work area clean, well-lighted, free of clutter and distractions, and accessible only by authorized personnel and workers.
- ADMS Control Module and touchscreen display must be located in accessible and well-lighted area for use, servicing, repair or replacement by authorized personnel.
- ADMS Control Module is electrically powered. ALWAYS take proper precautions to recognize, evaluate, and control electricity hazards during installation, programming, use and service/maintenance.

NOTICE

Installation of ADMS is performed by the owner using qualified and licensed trades such as plumbers and electricians, following all local, state, federal and other governmental requirements, and all building and construction codes and standards. Step-by-step installation instructions depend upon the application and the configuration of the building's water distribution system.

All installations require thorough flushing of all piping BEFORE installation, and testing for and eliminating all leaks before and after installation.

Check valves are recommended to prevent cross-flow.

Control Unit Connections (interior)

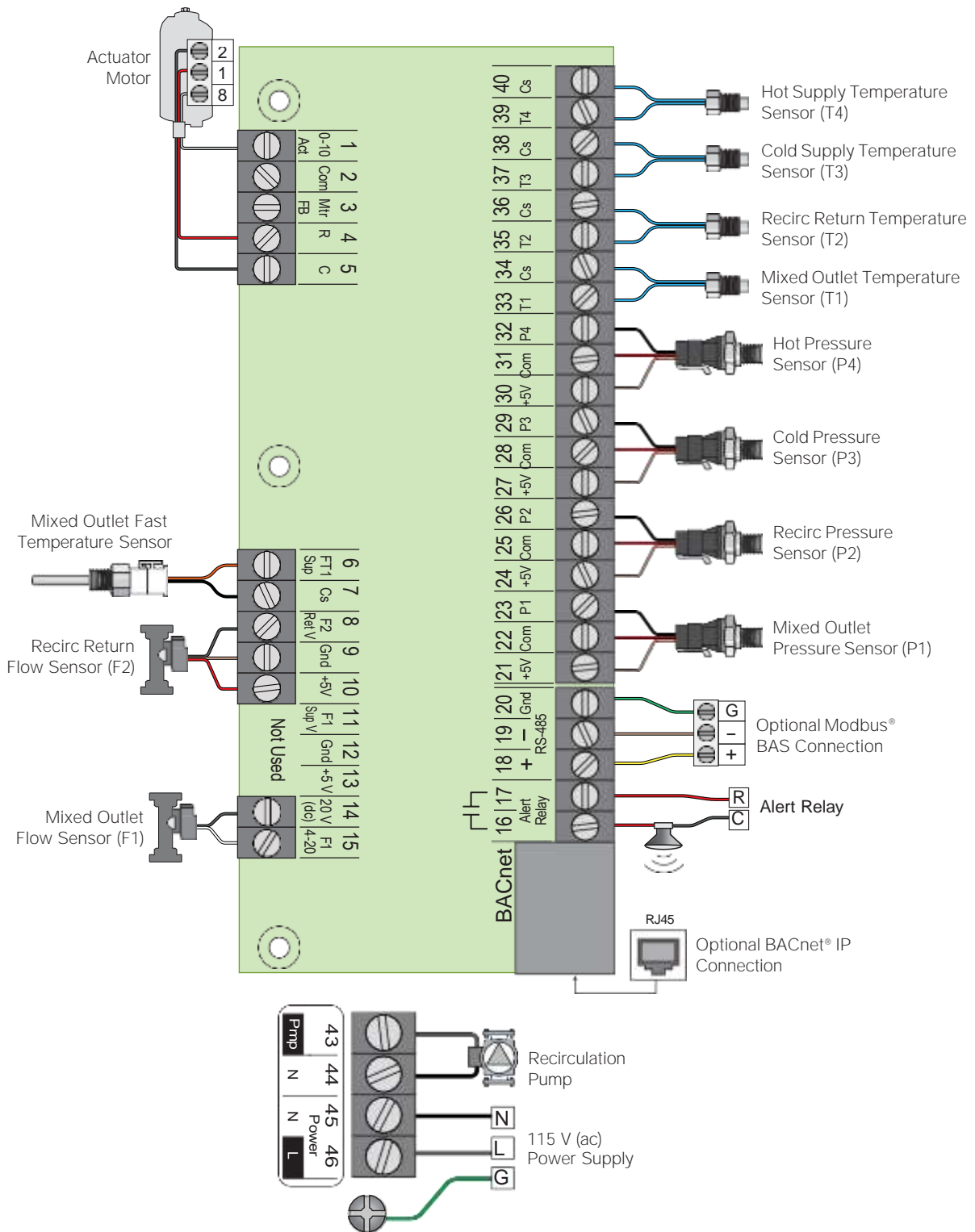

Description of Controls and Functions

The following sections generally outline and describe the controls and functions of the ADMS Control Module you will experience when using the digital display. See “Set Up and Programming” section of this Manual for use instructions.

 **WARNING**



Always read the Manual and all product labels and follow all safety and other information. If you are ever uncertain about a particular task or the proper method of operating this equipment, ask your supervisor, consult this Manual, or visit aerco.com

Control Module and Digital Display ■

The intelligence running the ADMS is contained within a Control Module. The color and touch screen digital display allows the user to view temperatures, pressures, flow rates throughout the system, and to configure the controls. The following sections describe and explain the user interface to assist in navigating and configuring the control.

After power up, the “Attention!” screen (shown below) will appear. You have 60 seconds to begin system navigation.

Start Up Screen

ATTENTION!

Control requires
60 seconds after
power up to begin
mixing operation.

Time remaining: 30 s

NOTICE

The Control will begin mixing operation after 60 seconds. The "Attention" message will appear again after 10 seconds of inactivity until the 60 seconds time has elapsed.

Description of Controls and Functions

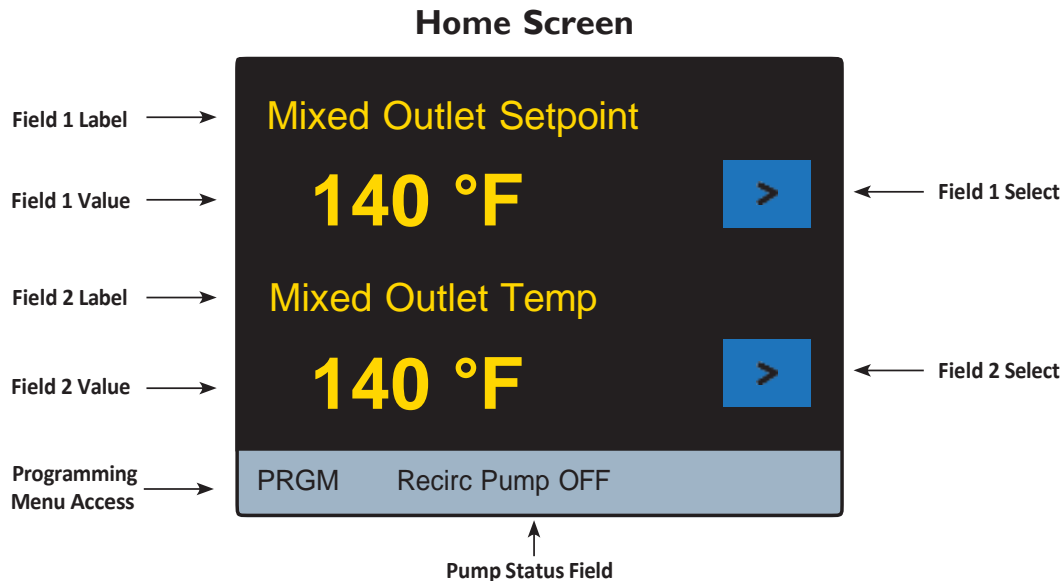

By touching the screen the user can access the "Home" screen, shown below.



As shown in the screen shot above, there are two fields viewable within the "Home" screen. For instance, the Label (item) and Value for Field 1 and Field 2 shown in the Home screen view above are:

Field 1 - "Mixed Outlet Set point" and value of "140°F."

Field 2 - "Mixed Outlet Temp" and value of "140°F."

The Label (item) displayed in the fields can be changed by touching the "Field Select"  icon to the right of each field value. The Labels (items) available for viewing on the Home screen by touching the "Field Select"  icon are shown in the table below:

Item	Description	Units
Mixed Outlet Setpoint	Temperature setpoint	°F or °C
Mixed Outlet Temp	Temperature measured at the mixing valve outlet	°F or °C
Hot Supply Temp	Temperature measured at the hot inlet	°F or °C
Cold Supply Temp	Temperature measured at the cold inlet	°F or °C
Recirc Return Temp	Temperature measured at the recirculation pump inlet	°F or °C
Mixed Outlet Pressure	Pressure measured at the mixing valve outlet	psi or KPa
Hot Pressure	Pressure measured at the mixing valve hot inlet	psi or KPa
Cold Pressure	Pressure measured at the mixing valve hot inlet	psi or KPa
Recirc Pressure	Pressure measured at the recirculation pump inlet	psi or KPa
Load Flow*	Difference between the mixed and recirc flow rates (F1 and F2)	gpm or m ³ /h or lpm
Mixed Outlet Flow*	Flow rate measured at the mixed outlet (F1)	gpm or m ³ /h or lpm
Recirc Flow*	Flow rate measured on the recirculation return piping (F2)	gpm or m ³ /h or lpm
Valve Position	Control Voltage supplied to the mixing valve	V
Mix Percent	Mixed percent hot to total flow, i.e. (Tmixed-Tcold)/(Thot-Tcold)	%

*Available on models with optional flow monitoring package

Description of Controls and Functions

Also shown on the Home screen is the Pump Status Field (showing if pump is ON or OFF), and the **PRGM** icon to access the Programming menu.

Touching the **PRGM** icon takes the user to the “Programming” Menu containing six function icons – “Unlock,” “Setup,” “Monitor,” “Sanitize,” “Home” and “Toolbox” - as shown below:

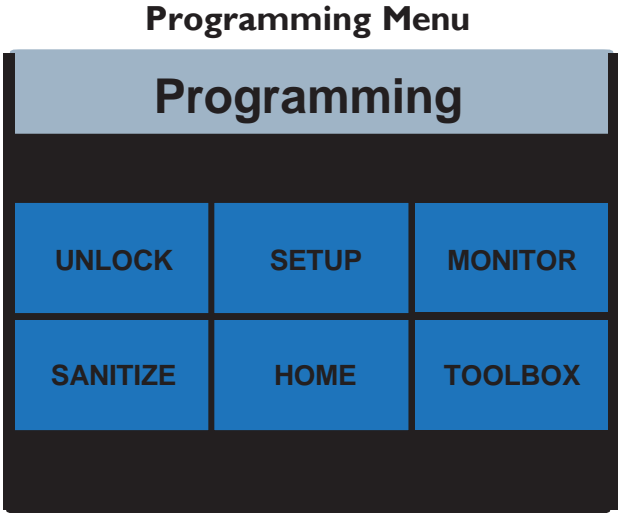

On the “Programming” Menu the **UNLOCK** and **HOME** icons are the only active icons until the control is unlocked. See “Unlock the System” in the “Set up and Programming” section of this Manual.

Touching the **HOME** icon takes the user back to the Home Screen.

Touching the **UNLOCK** icon takes the user to the “Unlock” function screen shown below:

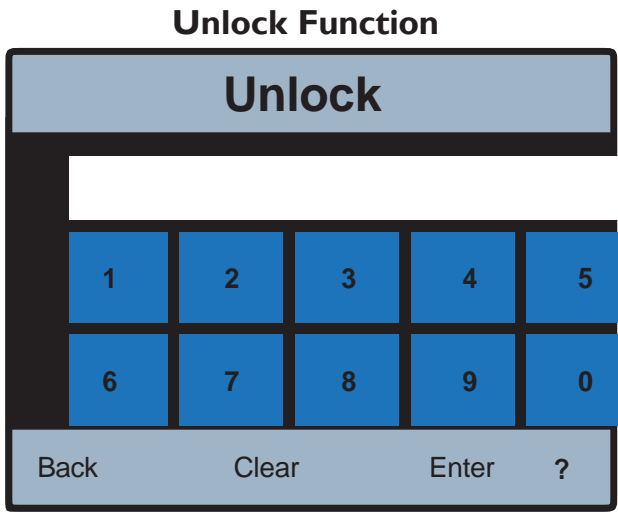

Description of Controls and Functions

To set and enter a passcode and unlock the system, follow instructions in the “Set Up and Programming” section of this Manual.

NOTICE

The **Enter** icon on the Unlock function screen is deactivated until the user enters the correct passcode.

The **Back** icon will take you back to the Programming Menu.

The **?** icon will show additional information if available.

After entering the correct passcode, the “Setup”, “Monitor”, “Sanitize” and “Toolbox” functions can be accessed from the “Programming” Menu screen.

The following Sections generally outline and describe these functions.

Touching the **SETUP** icon on the “Programming” Menu will allow access to the Setup function:

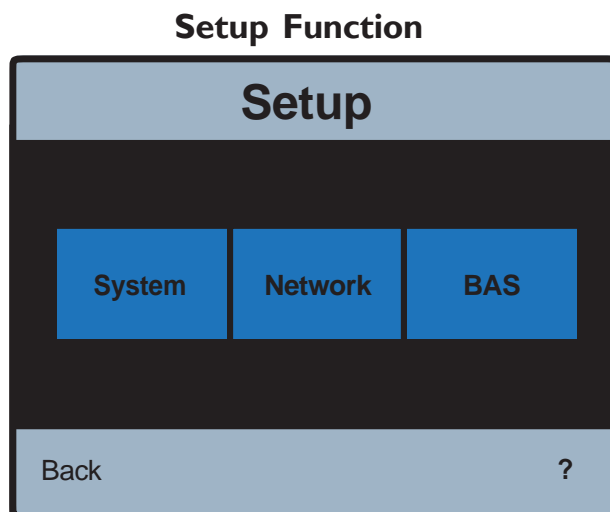

The Set up Function allows the user to access three menus:

- “System”
- “Network”
- “BAS”

Description of Controls and Functions

System Menu

System	
BAS Setpoint Max	140 °F
Mixed Out Setpoint	140 °F
High Temp Alert	150 °F
Pump Operation	Auto
Pump Head	0.0 psi
Pump Min On/Off Time	1 min
Return Target	130 °F
Return Differential	10 °F
Back	Up
Down	Enter
	?

The System Menu selections are generally described in the table below:

Item Field	Range	Default	Additional Info
BAS Setpoint Max	80 to Mixed Out Maximum - 10F (max value = 180°F)	140°F	Limit to the remote temperature adjustment (BAS) for added security and safety. If BAS is set to 'None' this field will not display.
Mixed Out Setpoint	80 to Mixed Out Maximum - 10F (max value = 180°F)	140°F	Mixed Outlet setpoint.
High Temp Alert	Mixed Out Setpoint +10F to 190°F	150°F	A mixed outlet temperature over this amount will create an error condition and issue a reset for the control.
Pump Operation	OFF <> ON <> AUTO	AUTO	DHW Recirculation pump control mode. AUTO-temperature differential and dead head protection. ON-Pump is always on. OFF-Pump is always off.
Pump Head	0.0 to 50.0 psi	8.5 psi	If the head measured across the pump is greater than this value, the pump will turn/remain off since it can not generate any flow at these operating conditions (Dead Head Protection)
Pump Min On/Off Time	0 to 60 min	1 min	The minimum time the pump runs or remains off.
Return Target	80°F to 180°F	130°F	The target temperature about which the pump relay will operate.
Return Differential	1°F to 20°F	10°F	The differential used to determine the pump on and pump off temperatures.

Description of Controls and Functions

Network Menu

Network					Network				
IP Configuration			Auto		IP Configuration			Manual	
MAC Address --->					IP Address --->				
					Subnet Mask --->				
					Gateway Address --->				
					MAC Address --->				
Back Up Down Enter ?					Back Up Down Enter ?				

The Network Menu selections are generally described in the table below:

Item Field	Range	Default	When Displayed	Description	Additional Info
IP Configuration	Manual<> Auto	Auto	Always		IP Address: 0.0.0.0 Netmask: 0.0.0.0 Gateway: 0.0.0.0
IP Address	0.0.0.1 to 255.255.255.255	192.168.0.1	IP Configuration=Manual	Use keypad entry 0 thru 9 key in IP Address Buttons on screen are OK, DEL, TAB, <-, -->, ?	
Subnet Mask	0.0.0.1 to 255.255.255.255	255.255.255.0	IP Configuration=Manual	Use keypad entry 0 thru 9 key in Subnet IP Address Buttons on screen are OK, DEL, TAB, <-, -->, ?	
Gateway Address	0.0.0.1 to 255.255.255.255	192.168.0.1	IP Configuration=Manual	Use keypad entry 0 thru 9 key in Gateway IP Address Buttons on screen are OK, DEL, TAB, <-, -->, ?	
MAC Address	aa:bb:ee:ff:11:22	Unique to each device	Always		MAC Address: 00:04:a3:62:59:8e

Description of Controls and Functions

BAS Menu

The BAS Menu selections are generally described in the table below:

Item Field	Range	Default	When Displayed	Description	Additional Info
BAS Type	NONE <> BAC-IP <> BAC-MSTP <> MODBUS	NONE	Always	Building Automation Type:	None = control runs in stand alone. BAC-IP = control is connected to a BACnet/IP system. BAC-MSTP = control is connected to a BACnet/MS-TP system. MODBUS = control is connected to a Modbus system.
BACnet DEVICE ID	0 to 4194303	1	BAS Type = BAC-IP or BAC-MSTP	Buttons on screen are OK, DEL, <-, --> ?	BACnet device ID
BACnet Port	1 to 65535	47808	BAS Type = BAC-IP	Use keypad entry 0 thru 9 key in BACnet PORT Buttons on screen are OK, DEL, <-, --> ?	BACnet Port
Register Foreign Dev	OFF<>ON	OFF	BAS Type = BAC-IP		Is a BACnet Device that has an IP subnet address different from those comprising the BACnet/IP network.
BBMD TIME	OFF, 30 to 65535	OFF	BAS Type = BACnet	Time-to-live (Seconds)	BACnet Broadcast Management. A specified time, extending that time by periodic (automatic) renewal requests.
			Register Foreign Dev ≠ OFF	Use keypad entry 0 thru 9 key in BBMD TIME	
				Buttons on screen are OK, DEL, <-, --> ?	
BBMD IP	0.0.0.1 to 255.255.255.255	127.127.127.127	BAS Type = BACnet	Use keypad entry 0 thru 9	BACnet Foreign device internet Protocol address. A numerical label assigned to the foreign device.
			Register Foreign Dev ≠ OFF	key in IP Address	
				Buttons on screen are OK, DEL, <-, --> ?	
BBMD PORT	0 to 65535	47808	BAS Type = BACnet	Use keypad entry 0 thru 9	BACnet Broadcast Management Port.
			Register Foreign Dev ≠ OFF	key in BBMD PORT	
				Buttons on screen are OK, DEL, <-, --> ?	
BAC-MSTP Address	0 to 127	1	BAS Type = BAC-MSTP	Buttons on screen are OK, DEL, <-, --> ?	Set the MSTP address. Each MSTP device must have a unique address.
BACnet Baud Rate	9600, 19K2, 38K4, 57K6, 76K8, 115K2	9600	BAS Type = BAC-MSTP	Slider, OK,<-, --> ?	BACnet MS/TP baud rate
Modbus Address	1 to 247	1	BAS Type = MODBUS	Radio buttons, OK, ?	Modbus Address:
					1 to 247
Modbus Data Type	RTU <> ASCII	RTU	BAS Type = MODBUS	Slider, OK,<-, --> ?	Modbus Data Type
					RTU or ASCII
Modbus baud Rate	1200, 4800, 9600, 14K4, 19K2, 28K8, 38K4, 57K6, 76K, 115K2	9600	BAS Type = MODBUS	Slider, OK,<-, --> ?	Modbus baud rate
Modbus Parity	None <> Odd <> Even	Even		Slider, OK,<-, --> ?	Modbus Parity type.

Description of Controls and Functions

Monitor Function ■

Touching the **MONITOR** icon on the “Programming” Menu will allow access to the Monitor Function:

System Monitor	
Current Error	---
Mixed Outlet High	109 °F
Mixed Outlet Low	91 °F
Energy Used	0 MBtu
Recirc Pump	0 hr
Hot Inlet High	158 °F
Hot Inlet Low	130 °F
Load Flow High	--- gpm
Back	Up
Down	Enter
	?



The Monitor Function allows access to the following fields:

Item Field	Range	When is it Displayed	Description	Additional Info
Current Error		Always		The highest priority error code.
Mixed Outlet High	-22 to 266°F	Always		The highest measured mixed outlet temperature since last cleared.
Mixed Outlet Low	-22 to 266°F	Always		The lowest measured mixed outlet temperature since last cleared.
Recirc Pump	0-65535 hrs	Always		Accumulated run time hours of pump since last cleared.
Hot Inlet High	-22 to 266°F	Always		The highest measured hot inlet temperature since last cleared.
Hot Inlet Low	-22 to 266°F	Always		The lowest measured hot inlet temperature since last cleared.
Pressure High	0-65535 psi	Always	psi or kPa	The highest measured DHW outlet pressure since last cleared.
			Resolution in tenths	
Pressure Low	0-65535 psi	Always	psi or kPa	The lowest measured DHW outlet pressure since last cleared.
			Resolution in tenths	
Energy	0-65535 Therms or GJ	Optional F1 and F2 Flow Sensors present		The accumulated energy usage since last cleared.
		System Supply Sensor present		
		System Return Sensor present		
Flow High	0-65535 gpm	Optional F1 and F2 Flow Sensors present	gpm or m ³ /h	The largest load flow measured since last cleared.
			Resolution in tenths	
Reset All	ON<>OFF	Always		Clear all monitored values to zero.

Description of Controls and Functions

Sanitize Function ■

 **DANGER**

The Sanitization function produces high temperature water at all point-of-use fixtures (faucets, sinks, tubs, showers, etc.). Only qualified and authorized personnel who fully understand the function's operation, output and risks, should use the Sanitization function, and only as part of and in compliance with, a thermal eradication protocol safely and properly designed by the owner or manager of the water distribution system. The owner or manager of the water distribution system has sole responsibility to protect end-users, facility employees or contractors, personnel performing the Sanitization, and bystanders from scalding, burning, thermal shock, or other hazards from possible exposure to water or any parts of the water distribution system during Sanitization and cool down period, until system water returns to a safe and proper outlet water temperature set point.

Always read and follow the User Guide & Instruction Manual.

 See “Sanitization” section of this Manual for use instructions.

Description of Controls and Functions

Touching the **SANITIZE** icon on the “Programming” Menu will allow access to the sanitization Function:

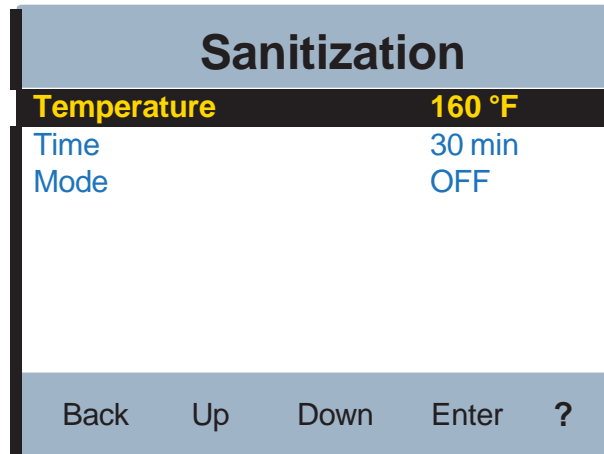

The Sanitization Function allows access to the following fields:

Item Field	Range	Default	When Displayed	Description	Additional Info
Temperature	120 to 180 °F	140 °F	After PIN correctly entered		The sanitization target temperature.
Time	0 to 600 mins	60 mins	After PIN correctly entered	Countdown starts once DHW is up to the Sanitization Temperature	Sanitization Timer.
Mode	ON <> OFF	OFF	After PIN correctly entered		Turn sanitization on or off.

Description of Controls and Functions

Toolbox Function ■

Touching the **TOOLBOX** icon on the “Programming” Menu will allow access to the Toolbox Function:

Toolbox				
Firmware	J1268A			
Load Defaults	No			
Temperature Units	°F			
Flow Units	gpm			
Energy Units	MBtu			
Pressure Units	psi			
Backlight	100 %			
Reset	No			
Back	Up	Down	Enter	?

The Toolbox Function allows access to the following fields:

Item Field	Range	Default	When is it Displayed	Additional Info
Firmware	J1268A	J1268A	Always	J1268A SVN XXX
Load Defaults	No <> Yes	No	Always	Reset the programmable settings to factory defaults.
Temperature Units	°F <> °C	°F	Always	Units used for temperature display.
Flow Units	gpm <> m³/h <> lpm	gpm	Optional F1 or F2 Flow Sensors present	Units used for Flow Rate display.
Energy Units	TH <> GJ <> MBtu <> kWh	MBtu	Optional F1 and F2 Flow Sensors present	Units used for calculated Energy Usage display.
Pressure Units	psi <> kPa	psi	Always	Units used for Pressure display.
Backlight	10 to 100 %	100%	Always	Adjust the brightness of the LCD backlight.
Reset	No <> Yes	No	Always	Reset the device.

Set up and Programming

Turn on Power ■

NOTICE

Before beginning, make sure all ball valves are in the fully open position. Double valve (DV) and Triple valve (TV) system must be set up as individual system described in this section.

1. Turn ADMS power "ON" by turning on the main switch.
2. When powered up, the display will show a 60 second countdown timer and read:



NOTICE

The control will begin mixing operations automatically after 60 seconds. During the 60 seconds the user may adjust setting and configure the control by touching anywhere on the screen to access the PRGM menu. If the user does nothing, the control will automatically route to the home screen after 60 seconds and begin normal operation.

3. The Home Screen will appear:

Home Screen

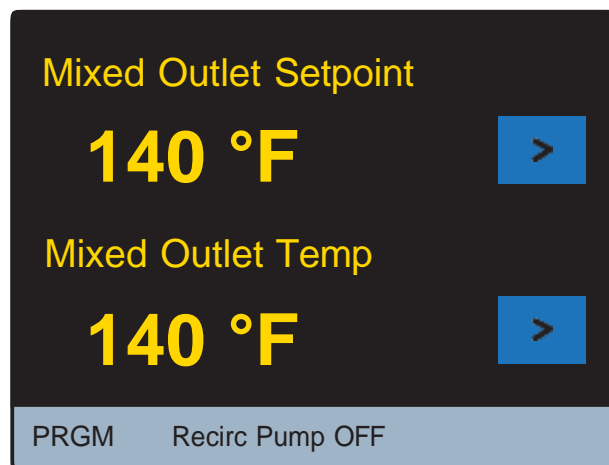

Set up and Programming

Create a passcode ■

NOTICE

The ADMS comes programmed with a factory default passcode (1017). For added security, and to help prevent unauthorized access, it is recommended that you create a unique 4 digit passcode as outlined below.

1. To select and set your own passcode, on the Home Screen, touch the **PRGM** icon in the lower left corner as shown below:

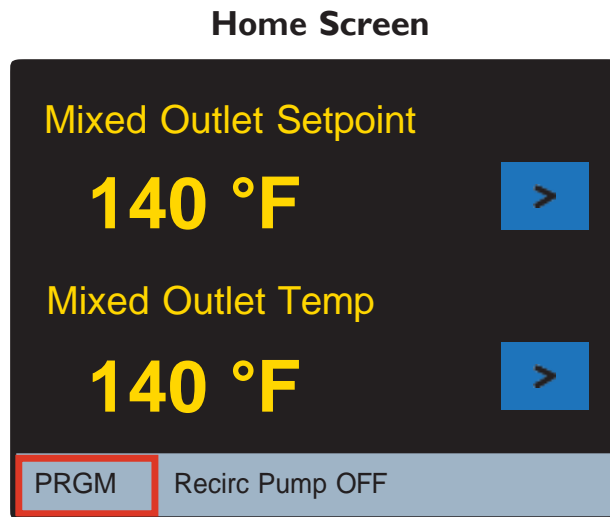

2. You will be directed to the Programming Menu, which appears as shown below:

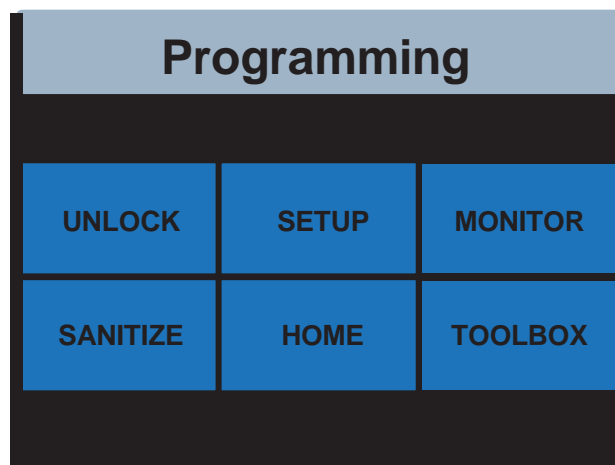

3. On the Programming Menu, touch the **UNLOCK** icon. The Unlock function screen will appear and you will be prompted to enter the passcode:

Set up and Programming

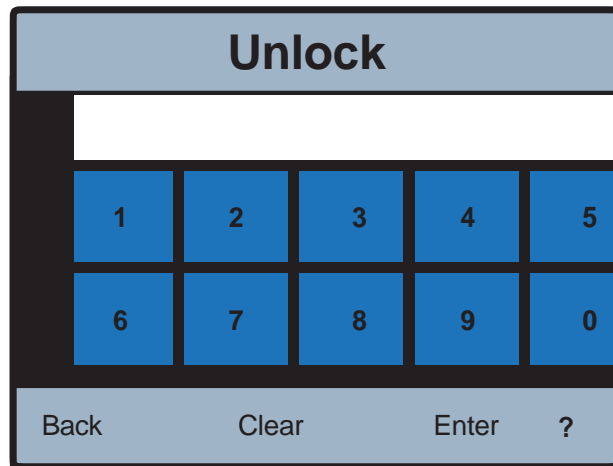

4. Creating your own passcode:

- To create your own passcode, enter the factory default passcode 1017 and press the **?** icon in the lower right corner of the Unlock screen.
- Enter a new 4-digit passcode and touch the **Enter** icon (make sure to keep your new code in a secure place).
- Re-enter the new passcode and touch the **Enter** icon again to finalize the passcode change.

NOTICE

If you make a mistake when re-entering your new passcode and it does not match your first entry, the **Enter** icon will be deactivated. If this happens, press **Clear** and try entering the new passcode again.

NOTICE

To reset the passcode to the factory setting, on the “Programming” menu, press and hold the **SETUP** icon for 10 seconds. When the passcode is reset, you will be automatically directed to the “Unlock” page.

Unlock the system ■

1. To unlock the system, on the Unlock screen, enter your new passcode, and touch the **Enter** icon.

NOTICE

If you need to clear your entry and start again, touch the **Clear** icon. If you want to go back to Programming Menu, touch the **Back** icon.

Set up and Programming

If you did not set up your own passcode, you can enter the factory default passcode 1017.

2. When the passcode is entered, you will be directed to the liability and responsibility acceptance screen:

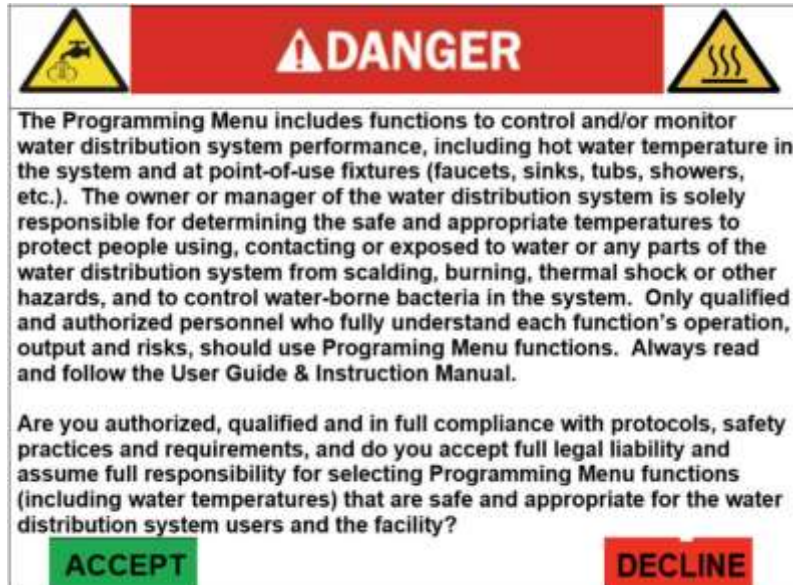

3. You must touch the **ACCEPT** icon to proceed to the Programming Menu and to use system functions.

Touching the **DECLINE** icon means you will not be able to change system settings and you accept all default settings (including the outlet water temperature set point of 120° F/ 49° C) as safe and appropriate for the water distribution system users and the facility. You will be returned to the "Programming" screen.

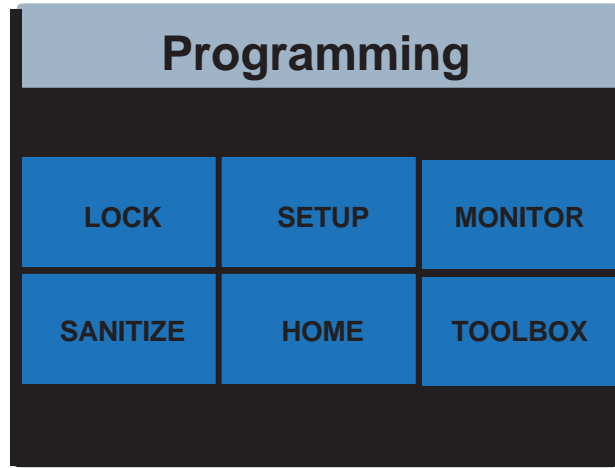

Set up and Programming

4. When you touch the **ACCEPT** icon, you will access the Programming Menu, which will appear as:



Selecting and adjusting the mixed outlet water temperature ■

! DANGER



The next steps involve selecting or adjusting the mixed outlet water temperature – the hot water temperature in the water distribution system and delivered to point-of-use fixtures (faucets, sinks, tubs, showers, etc.). The owner or manager of the water distribution system is solely responsible for determining the safe and appropriate temperatures to protect people using, contacting or exposed to water or any parts of the water distribution system from scalding, burning, thermal shock or other hazards, and to control water-borne bacteria in the system. Only qualified and authorized personnel who fully understand each function's operation, output and risks, should use Programming Menu functions. Always read and follow the User Guide & Instruction Manual.

Set up and Programming

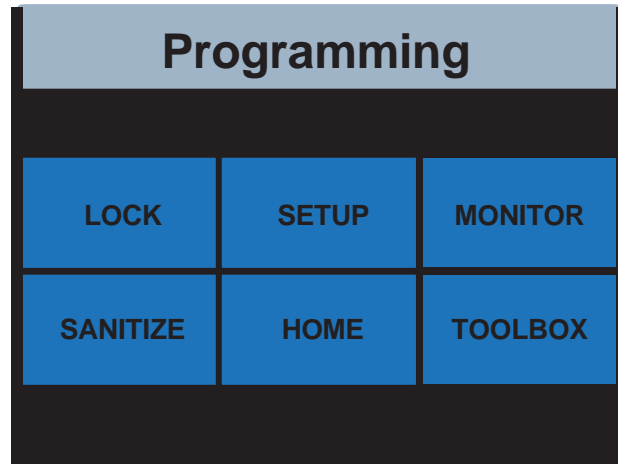

Touch the **SETUP** icon which will direct you to the Setup Menu which will appear as:

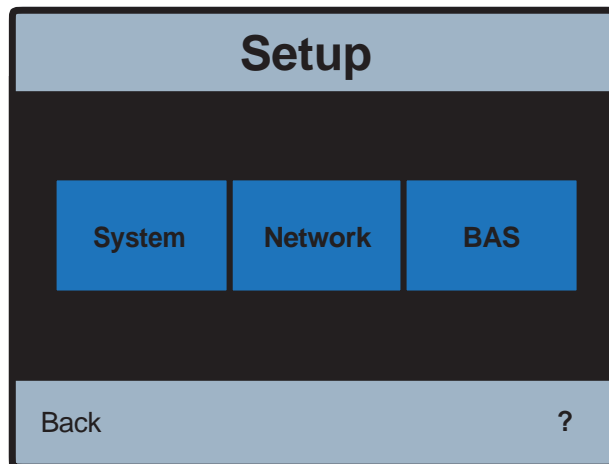



Set up and Programming

Touch the **System** icon which will direct you to the System Menu which will appear as:

System	
BAS Setpoint Max	140 °F
Mixed Out Setpoint	140 °F
High Temp Alert	150 °F
Pump Operation	Auto
Pump Head	0.0 psi
Pump Min On/Off Time	1 min
Return Target	130 °F
Return Differential	10 °F
Back	Up
Down	Enter
	?

2. Selecting and Setting Outlet Water Temperature Set-point:

 **WARNING**

 **BEFORE** setting mixed outlet water temperature or electing default temperature, point-of-use mixing valves and/or temperature limiting devices **MUST** be installed at all fixtures (faucets, sinks, tubs, showers, etc.)



Set up and Programming

Using the **Up** or **Down** icons, scroll through the System Menu and select:



Mixed Out Setpoint 140 °F

System	
BAS Setpoint Max	140 °F
Mixed Out Setpoint	140 °F
High Temp Alert	150 °F
Pump Operation	Auto
Pump Head	0.0 psi
Pump Min On/Off Time	1 min
Return Target	130 °F
Return Differential	10 °F

Back Up Down Enter ?

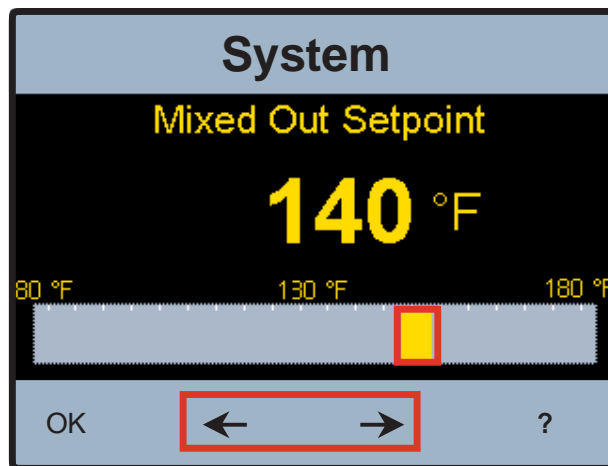
3. After selecting (highlighting) **Mixed Out Setpoint** 140 °F, touch **Enter** and you will be directed to the Mixed Out Setpoint selection page:



4. Select and set the safe, appropriate and desired outlet water temperature for your users, application and facility by using the slider icon  or by touching the right or left arrows  until the selected temperature is displayed.

Set up and Programming



The owner or manager of the water distribution system is solely responsible for determining the safe and appropriate temperatures to protect people using, contacting or exposed to water or any parts of the water distribution system from scalding, burning, thermal shock or other hazards, and to control water-borne bacteria in the system.

5. Once the desired temperature is selected, press the **OK** icon to apply the setting.

You will be returned to the System Menu screen.

Commissioning ■



You must confirm and test your outlet water temperature setting

1. **Confirming proper setting and operation:** With your desired Outlet Water Temperature Set Point selected and set, make sure the Mixed Outlet Temperature is within desired operating range.

Home Screen

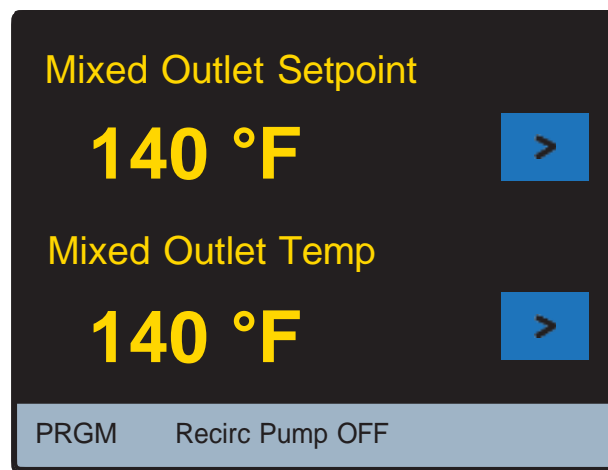

Set up and Programming



If you are finished at this time, the system will return to a locked state if not touched for 60 seconds.

Or, touch the **PRGM** icon twice to return to the “Programming” menu, then press **LOCK**

1. When the system is locked, the “Programming” menu will now display the **UNLOCK** icon, as shown below on left:

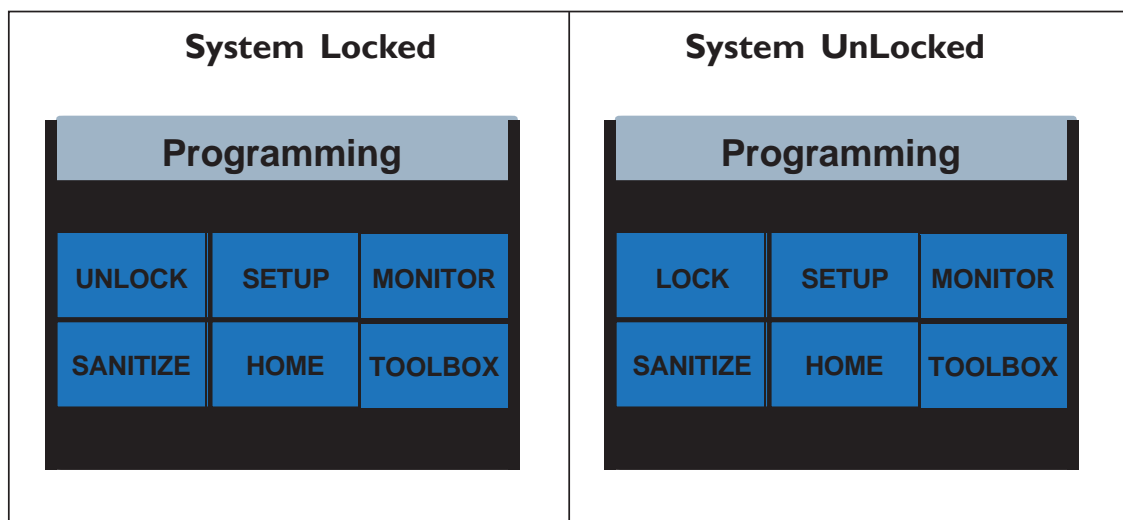

2. If you want to access other settings on the System Setup Menu, touch the **SETUP** icon on the “Programming” Menu and follow the instructions under **Accessing other settings on the System Setup Menu**, below.
3. If you are done with programming and settings at this time, touch the **HOME** icon on the “Programming” Menu and you will be returned to the Home Screen.

Set up and Programming

Accessing other settings on the System Setup Menu ■

1. From the “Programming” Menu, touch the **SETUP** icon to go to the System Setup Menu:

System	
BAS Setpoint Max	140 °F
Mixed Out Setpoint	140 °F
High Temp Alert	150 °F
Pump Operation	Auto
Pump Head	0.0 psi
Pump Min On/Off Time	1 min
Return Target	130 °F
Return Differential	10 °F
Back	Up
Down	Enter
	?

The System Set up menu options are as follows:



Menu Options	Description
System Setup	
BAS Setpoint Max	Maximum mixed outlet temperature the BAS system can set
Mixed Outlet Setpoint	Mixed outlet temperature setting
High Temp Alert	Temperature at which the control will issue a reset (min. 10F above setpoint).
Pump Operation	Pump setting. AUTO is temperature and pressure based pump control. ON, pump is always ON. OFF, pump is always OFF.
Pump Head	If pressure across the pump is greater than input value, pump will remain OFF
Pump Min On/Off Time	The minimum time the pump remains on or off
Return Target	Designated temperature of return line water from facility
Return Differential	Designated temperature delta to turn "on" recirculation pump should return line temperature fall below this value

Sanitization

The Sanitization function produces high water temperatures and is intended **ONLY** for use as part of a user-directed, controlled and supervised thermal eradication protocol that has been safely and properly designed to help limit water-borne bacteria within the tempered water distribution system. The instructions contained in this Manual for the Sanitization function are not intended to be a thermal eradication protocol.

Selecting, directing, and controlling a safe and properly designed thermal eradication protocol is the sole responsibility of the people who own, manage or control the water distribution system. It is their responsibility to protect water distribution end-users, facility employees or contractors, and bystanders from scalding, burning, thermal shock, or other hazards from possible exposure to water or any parts of the water distribution system during Sanitization and cool down period, until system water returns to a safe and proper outlet water temperature set point.

 **DANGER**

The Sanitization function produces high temperature water at all point-of-use fixtures (faucets, sinks, tubs, showers, etc.). Only qualified and authorized personnel who fully understand the function's operation, output and risks, should use the Sanitization function, and only as part of and in compliance with, a thermal eradication protocol safely and properly designed by the owner or manager of the water distribution system. The owner or manager of the water distribution system has sole responsibility to protect end-users, facility employees or contractors, personnel performing the Sanitization, and bystanders from scalding, burning, thermal shock, or other hazards from possible exposure to water or any parts of the water distribution system during Sanitization and cool down period, until system water returns to a safe and proper outlet water temperature set point. Always read and follow the User Guide & Instruction Manual.

Sanitization

1. On the Programming Menu

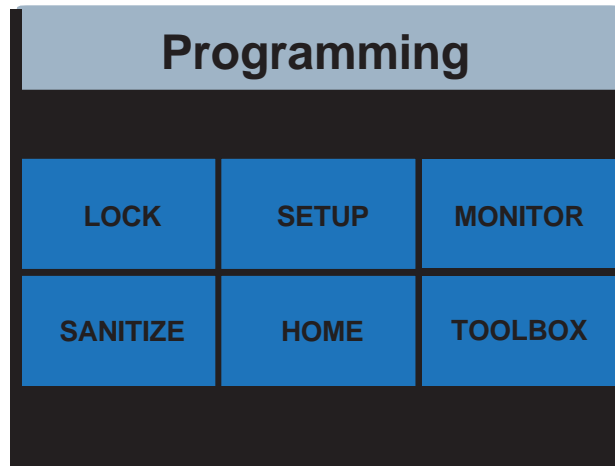

Touch the **SANITIZE** icon, which will direct you to the responsibility and liability acceptance page:



⚠ DANGER



The Programming Menu includes functions to control and/or monitor water distribution system performance, including hot water temperature in the system and at point-of-use fixtures (faucets, sinks, tubs, showers, etc.). The owner or manager of the water distribution system is solely responsible for determining the safe and appropriate temperatures to protect people using, contacting or exposed to water or any parts of the water distribution system from scalding, burning, thermal shock or other hazards, and to control water-borne bacteria in the system. Only qualified and authorized personnel who fully understand each function's operation, output and risks, should use Programming Menu functions. Always read and follow the User Guide & Instruction Manual.

Are you authorized, qualified and in full compliance with protocols, safety practices and requirements, and do you accept full legal liability and assume full responsibility for selecting Programming Menu functions (including water temperatures) that are safe and appropriate for the water distribution system users and the facility?

ACCEPT**DECLINE**

Sanitization

- 2. You must touch the **ACCEPT** icon to proceed with the Sanitization function.
 - Touching the **DECLINE** icon means you will be unable to utilize the Sanitization function and you will be returned to the “Programming” Menu page.
 - When you touch the **ACCEPT** icon, you will be directed to the Sanitization menu screen.
- 3. Select the Sanitization temperature first by highlighting the TEMPERATURE function on the Sanitization menu and then touching

NOTICE

During first 60 seconds upon power up, mode setting does not appear.

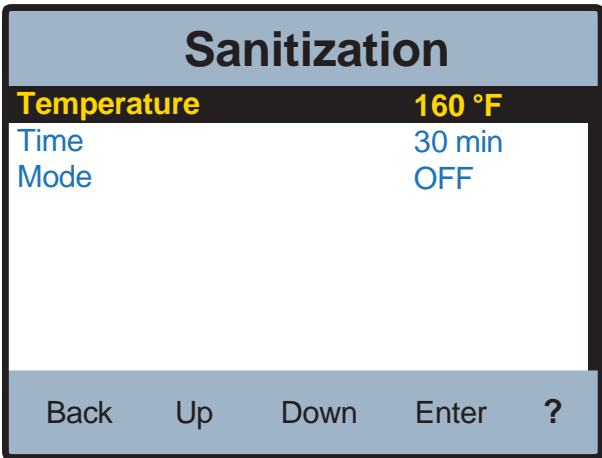

Enter

- 4. Using the slide bar or directional arrows select the desired outlet water temperature.

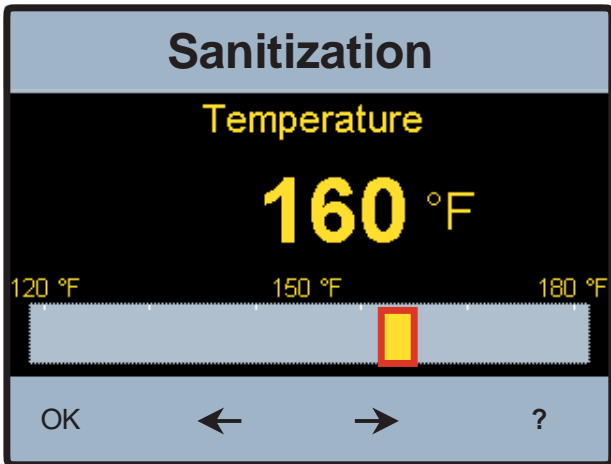

Sanitization

5. Next, select the run time in minutes by first highlighting the TIME function on the Sanitization menu and touching **Enter**.

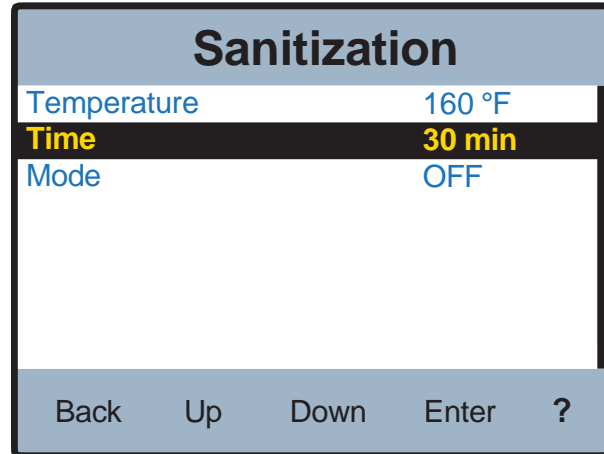

6. Using the  or  select the desired Run Time.

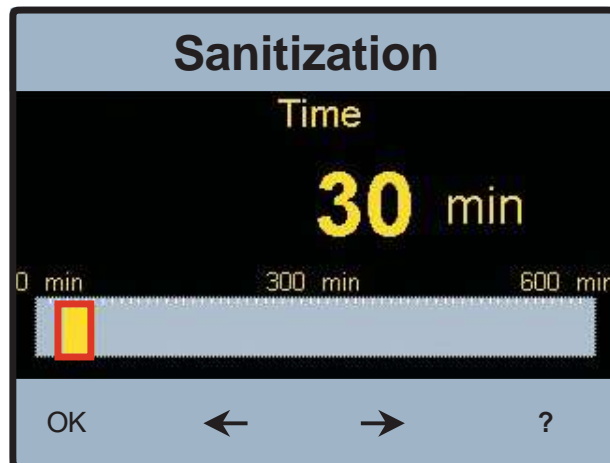

WARNING

BEFORE starting the Sanitization function, make sure you are in full compliance with a safely and properly designed thermal eradication protocol, protecting end-users, facility employees or contractors, personnel performing the Sanitization, and bystanders from scalding, burning, thermal shock, or other hazards.

Sanitization

7. To engage/start the Sanitization function, select MODE on the Sanitization menu and touch **Enter** .

NOTICE

During first 60 seconds upon power up, mode setting does not appear.

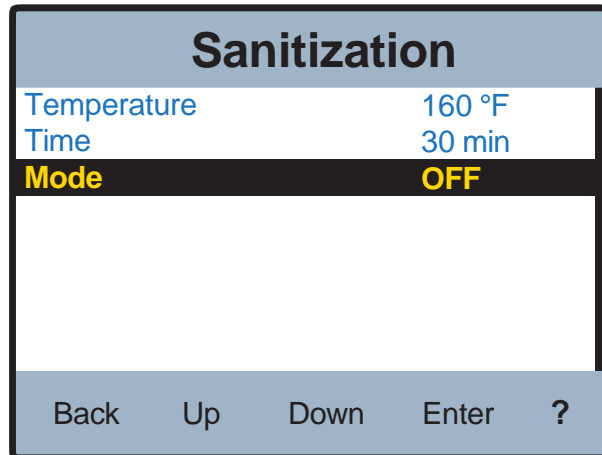

The screenshot shows a menu titled "Sanitization" with a light blue header. Below the header, there are three rows of text: "Temperature 160 °F", "Time 30 min", and "Mode OFF". The "Mode" text is highlighted in yellow. At the bottom of the screen, there is a navigation bar with the labels "Back", "Up", "Down", "Enter", and "?".

8. Once in the MODE menu, toggle to the ON radio button and then select **OK** .

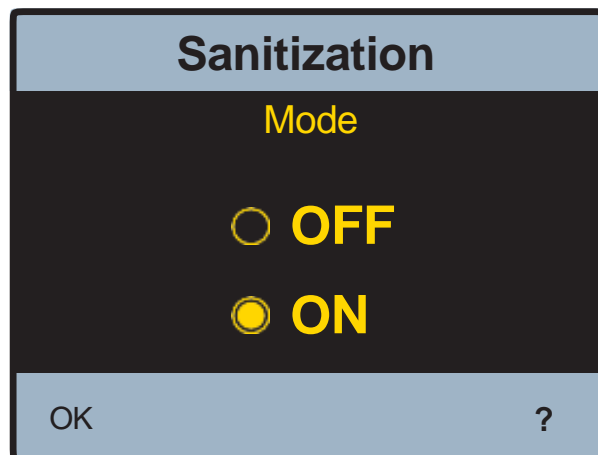

The screenshot shows a menu titled "Sanitization" with a light blue header. Below the header, the word "Mode" is centered in yellow. There are two radio button options: "OFF" and "ON". The "ON" option is selected, indicated by a yellow dot inside the radio button. At the bottom of the screen, there is a navigation bar with the labels "OK" and "?".

Sanitization

The Sanitization Mode is now fully functional. Note: The HOME screen will indicate you are Sanitizing the water delivery system and indicate Mixed Outlet Temperature.

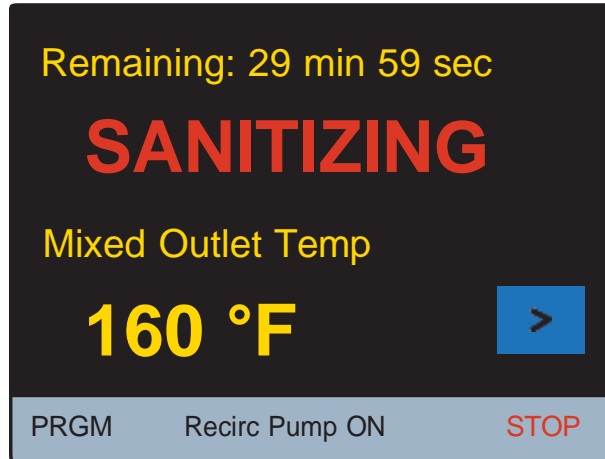

9. After Sanitization Mode has completed (user selected run time has elapsed), the ADMS will go into a Cool Down Mode to return to the Mixed Outlet temperature prior to sanitizing.

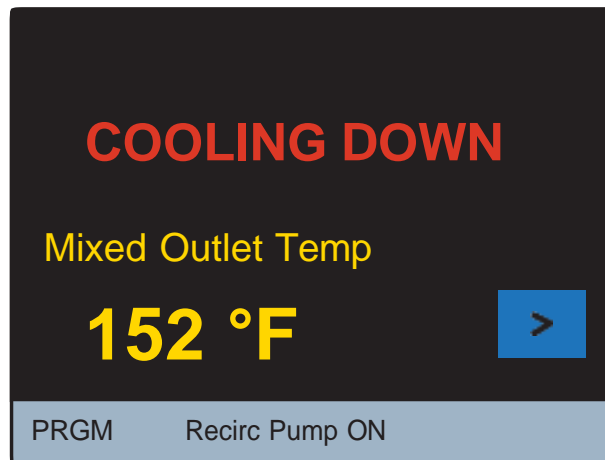

AERCO ADMS BAS Integration Manual

Configuring the Control for BAS communication ■



1. Configure the control to communicate using the “User Interface-BAS Menu” information within this manual and/or the “BAS Integration Manual.”

Introduction ■

The ADMS is equipped with a 1069 Control Module designed and programmed by tekmar Control Systems Ltd. This control can communicate with a Building Automation System (BAS) using BACnet® IP, BACnet® MSTP, or Modbus®. This manual provides information about the measurements, control parameters, and error messaging which can be accessed by building automation and/or management systems that use BACnet® IP, BACnet® MSTP, or Modbus® communication. The 1069 Control Module can be configured to provide remote monitoring and remote temperature set-point control from the connected BAS. See ADMS User Guide & Instruction Manual for additional information.

BAS Connection Procedure ■

 **DANGER**

BEFORE attempting to connect BAS, a certified and qualified electrician MUST fully de-energize and disconnect all electrical power from ADMS.

Perform required LOCK OUT/TAG OUT procedures.

BAS connection MUST be performed by certified and qualified electrician.

1. After completely de-energizing and disconnecting all power from ADMS and performing required LOCK OUT/TAG OUT, carefully open the ADMS control module by releasing latches to reveal BACnet® and Modbus® hook up terminals.

AERCO ADMS BAS Integration Manual



As an additional safety check, once the box is open, confirm that the unit is de-energized by measuring the AC voltage across the “L” and “N” terminals (46 and 45 respectively) using the voltmeter. Alternatively, use a voltage detector to confirm that the unit is NOT energized.

2. With the control module open, the BACnet®, Modbus®, and Alert Relay connections are visible on the bottom side of the main control board as shown below:

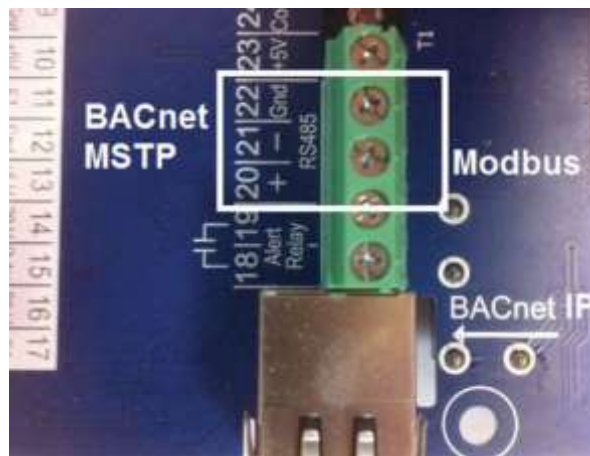

3. The control module has a plug installed in an unused hole through the enclosure to allow for easy installation of the BAS wires. Remove this plug and run the BAS wires through this hole to the control.

NOTICE

A grommet or wire protector (similar to those used on the other enclosure holes) should be used to protect the wire from being damaged by the enclosure hole opening.

AERCO ADMS BAS Integration Manual

4. If connecting the control to a BACnet® IP supported BAS system simply run a CAT-5E or CAT-6 cable from the BACnet® Network Switch and connect to the RJ45 Ethernet style jack on the board.

NOTICE

Cable length not to exceed 150 ft (45.7m) for CAT-5E, or 300 ft. (91.4 m) for CAT-6. Check continuity across each wire.

5. If connecting to a BACnet® MSTP system run the A(-), B(+), Gnd terminals from the nearest BAS system component and connect to terminals 21, 20, and 22 (+, -, Gnd) of the IntelliStation Control Module 1069.

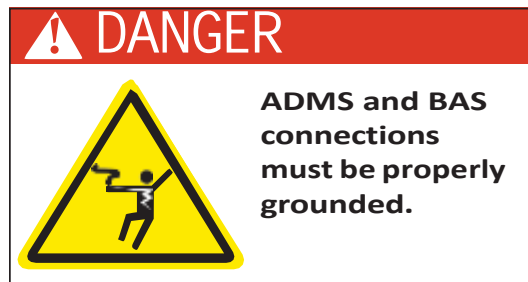

DO NOT ground to the enclosure. Ground (“Gnd”) terminal must be connected to terminal 22 marked “Gnd.”

6. If connecting to a Modbus® BAS system run the A-B-G terminals from the nearest the BAS system component and connect to terminals 20, 21, and 22.



DO NOT ground to the enclosure. Ground (“G”) terminal must be connected to terminal 22 marked “Gnd.”

If connecting the “Alert Relay” simply wire positive and negative wires to terminals 18, and 19.



If using the alert relay make sure not to exceed relay rating. The alert relay is rated for 5A @ 250 VAC, 5A @ 30 VDC and not polarity sensitive.

AERCO ADMS BAS Integration Manual

7. Once connected to the control close the enclosure and reconnect the power.

BACnet® and Modbus® Settings in the ADMS Control Module Menu ■

When the unit powers up it displays the warning message shown below until 60 seconds has elapsed. After 60 seconds the control will automatically redirect to the “Home” screen. The settings menu can be accessed prior to the time elapsing by touching anywhere on the screen.



From the home screen depress the **PRGM** icon to access the “Programming” menu.

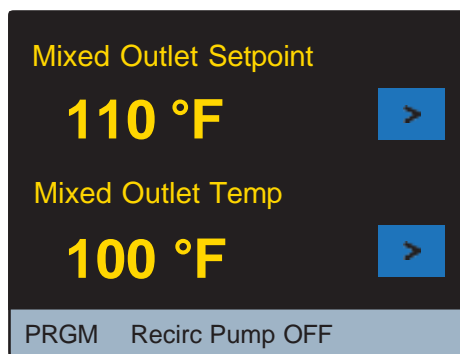

From within the “Programming” menu (shown below) only the **HOME** and **UNLOCK** icons are active until the control is in the unlocked state. Note: After 60 seconds of inactivity the control automatically locks and returns to the home screen.

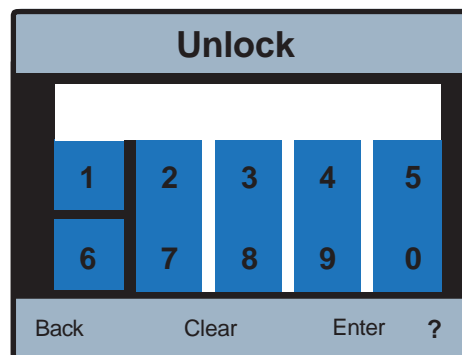
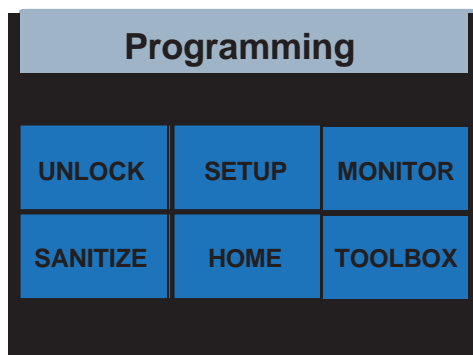

To unlock the control select the **UNLOCK** icon from within the “Programming” menu.

AERCO ADMS BAS Integration Manual

Unlock the control by entering “1017” and selecting the **Enter** icon. If the wrong code was entered select **Clear** to try again. Note: the **Enter** icon will only work if the correct code is entered. Once unlocked, the control automatically redirects to the “Programming” menu but this time the **UNLOCK** icon will appear as **LOCK** icon, indicating that the control is unlocked, and the other icons (SETUP, MONITOR, SANITIZE, TOOLBOX) will now be active.

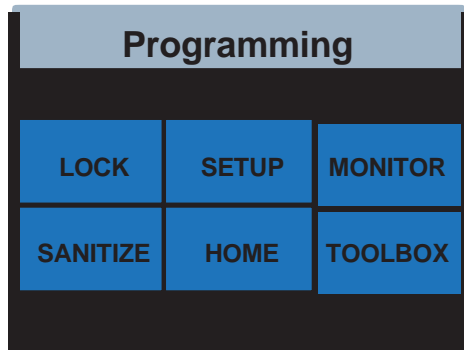

Select the **SETUP** icon from within the “Programming” menu to access the “Setup” menu shown below.

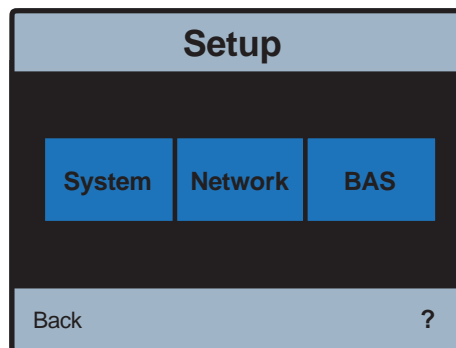

Select the **BAS** icon from within the “Setup” menu to access the “Building Automation” menu shown below.

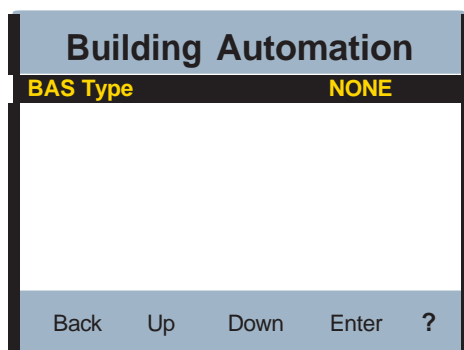

The default “BAS Type” is “NONE” as shown above. To change this setting press the **Enter** icon and the “BAS Type” adjustment screen will appear (as shown below).

AERCO ADMS BAS Integration Manual

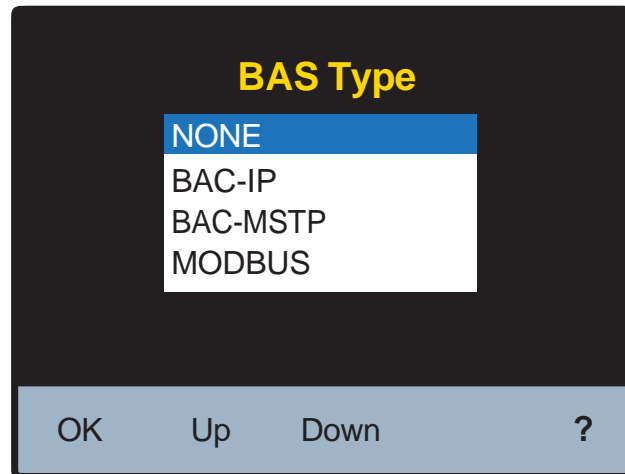

Depress the **Up** and **Down** icons to scroll through the BAS types and depress the **OK** icon to configure the control to the highlighted type and return to the "Building Automation" menu. Note: depending on the "BAS Type" selected, various user configurable items will now appear within the "Building Automation" menu. A table of the user definable items is shown on the next page.

The Building Automation "BAS Menu" shows default settings for each of the communication protocols supported by this control (BACnet® IP, BACnet® MSTP, or Modbus®).

AERCO ADMS BAS Integration Manual

BAS Menu

Item Field	Range	Default	When Displayed	Description	Additional Info
BAS Type	NONE <> BAC-IP <> BAC-MSTP <> MODBUS	NONE	Always	Building Automation Type:	None = control runs in stand alone.
					BAC-IP = control is connected to a BACnet/IP system.
					BAC-MSTP = control is connected to a BACnet/MS-TP system.
					MODBUS = control is connected to a Modbus system.
BACnet DEVICE ID	0 to 4194303	1	BAS Type = BAC-IP or BAC-MSTP	Buttons on screen are OK, DEL, <-, --> ?	BACnet device ID
BACnet Port	1 to 65535	47808	BAS Type = BAC-IP	Use keypad entry 0 thru 9	BACnet Port
				key in BACnet PORT	
				Buttons on screen are OK, DEL, <-, --> ?	
Register Foreign Dev	OFF<>ON	OFF	BAS Type = BAC-IP		Is a BACnet Device that has an IP subnet address different from those comprising the BACnet/IP network.
BBMD TIME	OFF, 30 to 65535	OFF	BAS Type = BACnet	Time-to-live (Seconds)	BACnet Broadcast Management. A specified time, extending that time by periodic (automatic) renewal requests.
			Register Foreign Dev ≠ OFF	Use keypad entry 0 thru 9	
				key in BBMD TIME	
BBMD IP	0.0.0.1 to 255.255.255.255	127.127.127.127	BAS Type = BACnet	Use keypad entry 0 thru 9	BACnet Foreign device internet Protocol address. A numerical label assigned to the foreign device.
			Register Foreign Dev ≠ OFF	key in IP Address	
				Buttons on screen are OK, DEL, <-, --> ?	
BBMD PORT	0 to 65535	47808	BAS Type = BACnet	Use keypad entry 0 thru 9	BACnet Broadcast Management Port.
			Register Foreign Dev ≠ OFF	key in BBMD PORT	
				Buttons on screen are OK, DEL, <-, --> ?	
BAC-MSTP Address	0 to 127	1	BAS Type = BAC-MSTP	Buttons on screen are OK, DEL, <-, --> ?	Set the MSTP address. Each MSTP device must have a unique address.
BACnet Baud Rate	9600, 19K2, 38K4, 57K6, 76K8, 115K2	9600	BAS Type = BAC-MSTP	Slider, OK,<-, --> ?	BACnet MS/TP baud rate
Modbus Address	1 to 247	1	BAS Type = MODBUS	Radio buttons, OK, ?	Modbus Address:
					1 to 247
Modbus Data Type	RTU <> ASCII	RTU	BAS Type = MODBUS	Slider, OK,<-, --> ?	Modbus Data Type
					RTU or ASCII
Modbus baud Rate	1200, 4800, 9600, 14K4, 19K2, 28K8, 38K4, 57K6, 76K, 115K2	9600	BAS Type = MODBUS	Slider, OK,<-, --> ?	Modbus baud rate
Modbus Parity	None <> Odd <> Even	Even		Slider, OK,<-, --> ?	Modbus Parity type.

AERCO ADMS BAS Integration Manual

Building Automation		Building Automation		Building Automation	
BAS Type	BAC-IP	BAS Type	BAC-MSTP	BAS Type	MODBUS
BACnet Device ID	0000000	BACnet Device ID	0000001	Modbus Address	1
BACnet Port	47808	BAC-MSTP Address	001	Modbus Data Type	RTU
Register Foreign Dev	OFF	BACnet Baud Rate	9600	Modbus Baud Rate	9600
				Modbus Parity	Even
Back	Up	Down	Enter	?	

Each of the settings can be adjusted by depressing the **Up** and **Down** icons to highlight the setting of interest and depressing the **Enter** icon to adjust the setting.

BACnet® Specific Settings ■

The “BACnet Device ID” setting adjustment screen is shown below.

BACnet Device ID

0000000

1 2 3 4 5

6 7 8 9 0

OK Del ← → ?

To adjust the ID depress the **Del** key 7 times and enter an ID appropriate for the remainder of the BAS system and press **OK**. Similarly, enter an appropriate “BACnet Port.” To change “Register Foreign Dev” to “ON” scroll down to “Register Foreign Dev” using the **Up** and **Down** icons and select **Enter**. The “Register Foreign Dev” setting adjustment screen is shown in the “OFF” state below.

Building Automation

Register Foreign Dev

OFF

ON

OK ?

To toggle from “OFF” to “ON” press on the  icon next to the “ON” setting to change the  icon to  indicating that this state is what is selected. Press **OK** to save this setting and return to the “Building Automation” menu shown below with “Register Foreign Dev” set to “ON”. Note the additional setting available with the “Register Foreign Dev” set to “ON.”

AERCO ADMS BAS Integration Manual

Building Automation				
BAS Type	BAC-IP			
BACnet Device ID	0000001			
BACnet Port	47808			
Register Foreign Dev	ON			
BBMD Time	00000			
BBMD IP Address	--->			
BBMD Port	47808			
Back	Up	Down	Enter	?

The “BBMD Time” and “BBMD Port” are adjusted similarly to the “BACnet Device ID.” The “BBMD IP Address” adjustment screen is shown below.

BBMD IP Address					
127	127	127	777		
1	2	3	4	5	
6	7	8	9	0	
OK	Del	Tab	←	→	?

Use the **Tab** icon to move between the four groups of three numbers, use the **←** **→** to move around in each group of 3 numbers, and use the **Del** to delete the numbers entered in the field to allow entering a new number.

Note: for additional information on configuring the BACnet® settings see the “BACnet® Specifications” of this document.

Modbus® Specific Settings ■



The settings available with the BAS Type are shown below. Each of the settings can be adjusted by depressing the **Up** and **Down** icons to highlight the setting of interest and depressing the **Enter** icon to adjust the setting.

Building Automation				
BAS Type	MODBUS			
Modbus Address:	1			
Modbus Data Type	RTU			
Modbus Baud Rate	9600			
Modbus Parity	Even			
Back	Up	Down	Enter	?

AERCO ADMS BAS Integration Manual

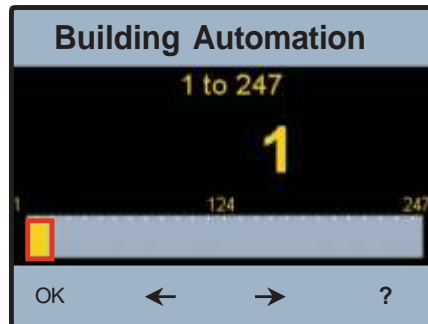

The “Modbus Address” setting adjustment screen is shown below.

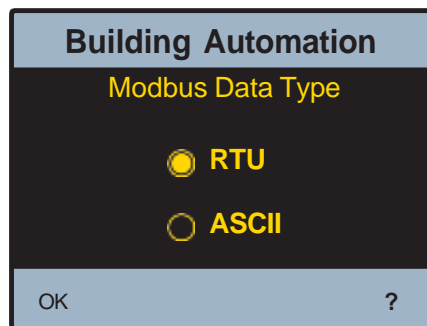

To adjust the “Modbus Address” either press anywhere on the slider bar  and/or use the arrow keys   and then select **OK** to save the setting and return to the “Building Automation” menu. The “ModBus Baud Rate” and “Modbus Parity” are adjusted in a similar fashion.

The “Modbus Data Type” settings adjustment screen is shown below.



To toggle from “RTU” to “ASCII” press on the  icon next to the “ASCII” setting to change the  icon to  indicating that this state is what is selected. Press **OK** to save this setting and return to the “Building Automation” menu.

Note: for additional information on configuring the Modbus settings see the “Modbus® Specifications” of this document.

AERCO ADMS BAS Integration Manual

BACnet® Protocol Implementation Statement (PICS) ■

Vendor Name: tekmar Control Systems Ltd.

Vendor ID: 983

Product Name: ADMS Smart Water Tempering System

Product Model Number: 106902

Application Software Version: J1268A BACnet Protocol Revision: 10

Product Description:

The ADMS is a mixing control designed to deliver tempered water to plumbing fixtures. The control uses a Proportional Integral (PI) logic to accurately maintain a target temperature by mixing a high temperature water source with a low temperature water source. This control also offers advanced features including communication with a Building Automation System (BAS).



ADMS provides user-directed control and monitoring of water distribution systems. It is the user's responsibility to select and maintain water temperatures and pressures that are safe and appropriate for the water system users, guests and facility. ADMS' Sanitization mode is intended for use as part of a user-directed, controlled and supervised protocol that has been safely and properly designed. It is recommended to install ADMS™ as part of a ASSE 1070 compliant water distribution system, including point-of-use mixing valves. Always read and follow User Guide & Instruction Manual and all product warnings and labels, and comply with all governmental and safety requirements.

BACnet Standardized Device Profile (ANNEX L)
BACnet Application Specific Controller (B-ASC)

Supported BIBBs (Annex K)	Name
DS-RP-B	Data Sharing-ReadProperty-B
DS-RPM-B	Data Sharing-ReadPropertyMultiple-B
DS-WP-B	Data Sharing-WriteProperty-B
DM-DDB-B	Device Management-Dynamic Device Binding-B
DM-DOB-B	Device Management-Dynamic Object Binding-B
DM-DCC-B	Device Management-Device Communication Control-B

Note: Device communication control password is "AERCO1017".

Segmentation Capability	Supported
Able to transmit segmented messages	No
Able to receive segmented messages	No

Standard Object Types Supported	Creatable	Deletable
Analog Input	No	No
Analog Value	No	No
Binary Output	No	No

Data Link Layer	Supported
BACnet® IP (Annex J)	Yes
BACnet® MSTP	Yes

Device Address Binding	Supported
Static Device Address Binding	No

Network Security Options
Non-Secure Device

Character Set	Supported
ANSI X3.4	Yes

AERCO ADMS BAS Integration Manual

BACnet® Analog Parameters ■

Analog Input Objects= AI

Analog Value Object=AV

Read=R

Read/Write= R/W

Analog Input Objects

Object ID	Data Type	Name	Description	Read/Write	Units	Range/Value
0	AI	DHW Temp	Mixed outlet temperature	R	°F	50 to 180
1	AI	DHW Recirc Temp	Recirculation return temperature	R	°F	50 to 180
2	AI	Hot Temp	The hot inlet supply temperature	R	°F	50 to 180
3	AI	Cold Temp	The cold inlet supply temperature	R	°F	50 to 180
4	AI	DHW Pressure	The mixed outlet pressure	R	psi	0 to 200
5	AI	DHW Recirc Pressure	Recirculation Pump Inlet Pressure	R	psi	0 to 200
6	AI	Hot Pressure	Hot supply inlet pressure	R	psi	0 to 200
7	AI	Cold Pressure	Cold supply inlet pressure	R	psi	0 to 200
8	AI	DHW Flow	Mixed Outlet Flow Rate	R	gpm	0 to 160
9	AI	Recirc Flow	Recirculation Return Flow Rate	R	gpm	0 to 40
10	AI	DHW Target Max	Maximum remotely adjusted DHW target	R	°F	50 to 180
11	AI	Mix %	(DHW Temp-Cold Temp)/(Hot Temp-Cold Temp)	R	%	0 to 100%
12	AI	Energy Used	Totalized Energy Consumed through the Product	R	Therms	0 to 3.4*10 ³⁴
13	AI	Error Code	Numerical error	R		0 to 30
Other	AI	ERROR	ERROR	ERROR	ERROR	ERROR

Analog Value Objects

Object ID	Data Type	Name	Description	Read/Write	Units	Range/Value
0	AV	DHW Target	Mixed outlet temperature target	R/W	°F	50 to 180
Other	AV	ERROR	ERROR	ERROR	ERROR	ERROR

BACnet® Binary Parameters ■

This control does not have any binary input parameters.

Binary Output Parameters

Object ID	Data Type	Name	Description	Read/Write	Units	Range/Value
0	BO	Recirc Pump Relay	Recirculation pump Status	R	N/A	0=off, 1= on
other	BO	Error	Communication Error	R	N/A	0=no, 1= yes

BACnet® Troubleshooting ■

If there is no or intermittent communication, check the following:

- Check the ethernet cable. Cable length must not exceed 150 ft. (45.7 m) for CAT-5E or 300 ft. (91.4 m) for CAT-6
- If the cable was manually made, check continuity across each of the wires.

AERCO ADMS BAS Integration Manual

Modbus® Specifications ■

Communication Protocol	Modbus over RS485
Physical Layer	RS485 Two-Wire plus Signal Ground
Baud Rate	2400, 9600, 19200, 57.6k, 115k)
	(default 19200 bps)
Recommended Cable	18 AWG Shielded Twisted-Pair (STP)
Transmission Mode	RTU or ACSII (default RTU)
Maximum Cable Length	Without terminating resistors
	- 115,000 baud --> 177 m (580 ft)
	- 57,600 baud --> 353 m (1,158 ft)
	- 19,200 baud --> 1,000 m (3,280 ft)
	- 9,600 baud --> 1,000 m (3,280 ft)
	- 2,400 baud --> 1,000 m (3,280 ft)
	With 2 x 120 Ohm resistors
	- 115,000 baud --> 1,000 m (3,280 ft)
	- 57,600 baud --> 1,000 m (3,280 ft)
	- 19,200 baud --> 1,000 m (3,280 ft)
	- 9,600 baud --> 1,000 m (3,280 ft)
	- 2,400 baud --> 1,000 m (3,280 ft)
Start Bit	1 Bit
Data Length	8 Bits for RTU Mode
	7 Bits for ACSII Mode
Parity	None (2 Stop Bits)
	Even (1 Stop Bit)
	Odd (1 Stop Bit)
	(default Even)
Addressing	1 to 247 (default 1)

AERCO ADMS BAS Integration Manual

Modbus® Parameters ■

Read=R

Read/Write=R/W

System Status Register

Register	Parameter Name	Read/Write	Units	Type	Format	Range
1	DHW Target Max	R	°F	Input	U16	50 to 180°F
2	DHW Temp	R	°F	Input	U16	50 to 220°F
3	DHW Recirc Temp	R	°F	Input	U16	50 to 220°F
4	Hot Temp	R	°F	Input	U16	50 to 220°F
5	Cold Temp	R	°F	Input	U16	50 to 220°F
6	DHW Pressure	R	psi x 10	Input	U16	0 to 170 psi
7	DHW Recirc Pressure	R	psi x 10	Input	U16	0 to 170 psi
8	Hot Pressure	R	psi x 10	Input	U16	0 to 170 psi
9	Cold Pressure	R	psi x 10	Input	U16	0 to 170 psi
10	Valve Position	R	%	Input	U16	0 to 100%
11	Pump Status	R	on/off	Input	U16	0 = off, 1 = on
12	DHW Flow	R	gpm	Input	U16	0 to 160
13	DHW Recirc Flow	R	gpm	Input	U16	0 to 40
14	Energy Used	R	therms	Input	U16	0 to 65535
15	Error Code	R	Enum	Input	U16	See Error Code list

System Parameter Register

Register	Parameter Name	Read/Write	Units	Type	Format	Range
1	DHW Target	R/W	°F	Holding	U16	50°F to Target Max

Product Information

Register	Parameter Name	Read/Write	Units	Type	Format	Range
1	Model	R	Num	Input	U16	Product model - "1069"
2	Firmware Revision	R	Num	Input	U16	SVN revision

Modbus® Troubleshooting ■

If there is no communication, check the following:

- Check that the polarity on the Modbus® + and – terminals is correct.
- Check that the Modbus® GND terminal is securely connected.
- Check that the Baud Rate on both devices are the same.

If the communication is intermittent, check the following:

- Check that the communication cable is of twisted pair type.
- Reliable communication depends on the cable length & Baud Rate used. Long cable length may require a lower Baud Rate.

AERCO ADMS BAS Integration Manual

Error Codes ■

Code	Description
1	NVM Error
2	Faulty Mixed Outlet (T1) sensor
3	Faulty Mixed Outlet (FT1) sensor
4	Faulty Recirc Return (T2) sensor
5	Faulty Cold Supply (T3) sensor
6	Faulty Hot Supply (T4) sensor
7	Faulty Mixed Outlet Pressure (P1) sensor
8	Faulty Recirc Return Pressure (P2) sensor
9	Faulty Cold Supply Pressure (P3) sensor
10	Faulty Hot Supply Pressure (P4) sensor
11	Faulty Mixed Outlet Flow (F1) sensor
12	Faulty Recirc Return Flow (F2) sensor
13	Max Temp Exceeded



Troubleshooting

Problem: Unstable control is observed at flow rates greater than the minimum rated flow

Solution: **Balancing Routine**

1. The Balancing Routine is designed to give the software additional information regarding the normal operating balance of the system to eliminate the need for a balancing valve.
2. To conduct the Balancing Routine it is necessary to generate a load larger than the minimum rated flow rate using the following procedure.

! WARNING

To avoid scalding, burning, thermal shock or other hazards DO NOT use or allow anyone to use the water at any point-of-use fixture (faucets, sinks, tubs, showers, etc.) in the facility's water distribution system during Balancing Routine.

The Balancing Routine can cause higher temperature water in the system and delivered to point-of-use fixtures (faucets, sinks, showers, etc.). Only qualified and authorized personnel who fully understand the Balancing Routine's operation, output and risks, should perform this action.

Personnel performing Balancing Routine and the owner or manager of the water distribution system MUST take appropriate safeguards to protect people from using, contacting or exposure to water or any parts of the water distribution system. Always read and follow the User Guide & Instruction Manual.

3. Attach a 1" hose to the pump inlet hose connection and ensure that the other end of the hose is securely routed to a drain.

Troubleshooting

4. Once you are sure that the hose connection has a safe path to a drain, open the pump inlet hose connect (1) and ensure that the pump inlet isolation valve (2), the mixed outlet isolation valve (3), the hot inlet isolation valve (4), the cold inlet isolation valve (5), and the hose connection valve (6) are in the fully open position.

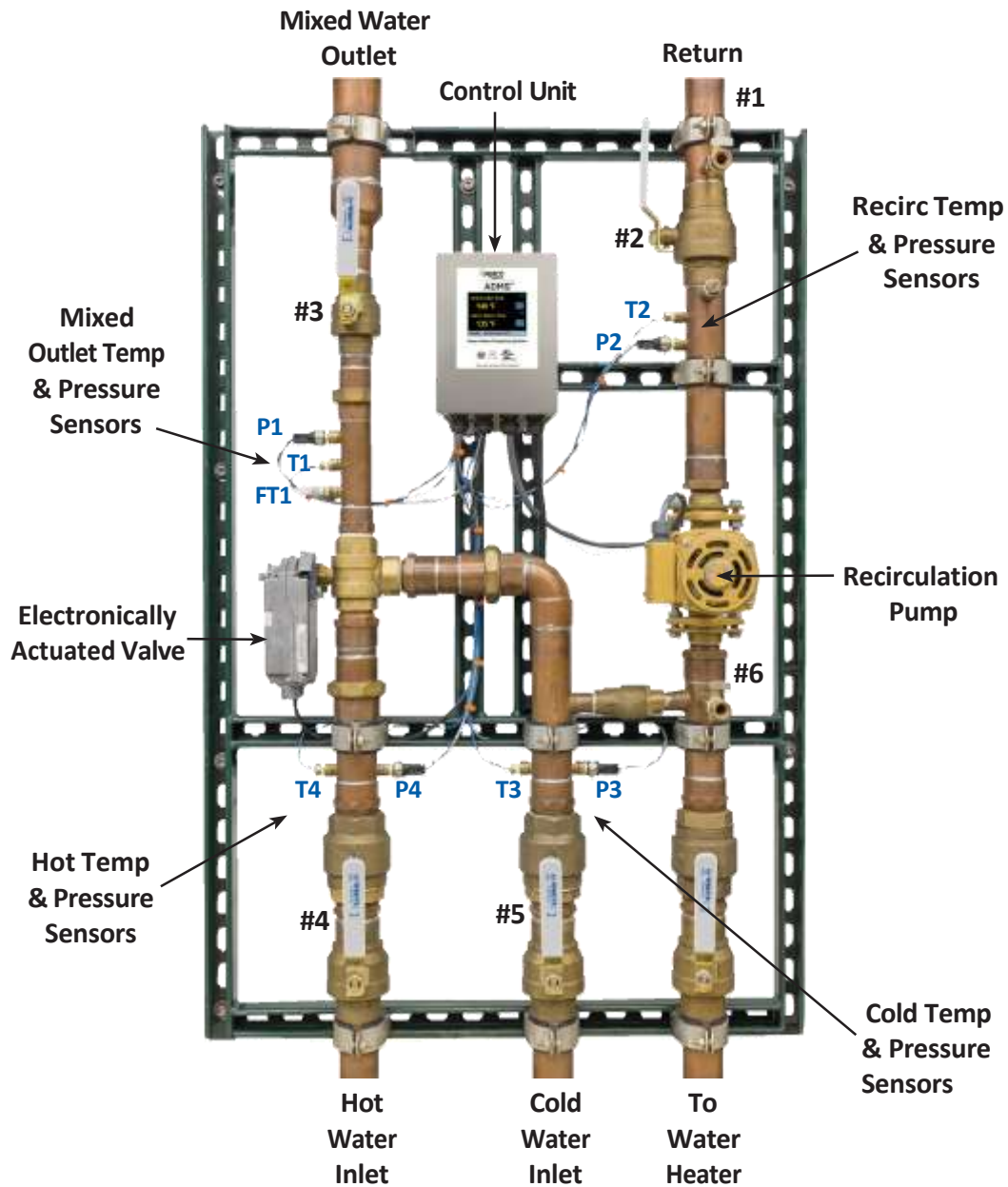

Troubleshooting

Problem: Outlet temperature is below set point temperature and/or the low temperature alarm has been activated

Solution:

1. Depending on the heating plant plumbing and location, it may take several minutes for the hot water to reach the panel. Ensure that you have allowed enough time (5 minutes) for the system to come up to temperature.
2. On the Home screen, check the “Mixed Outlet Setpoint” and the “Hot Supply Temp” using the  icon to cycle through the fields. The “Hot Supply Temp” needs to be above the set-point or the panel will not be able to reach the set-point.

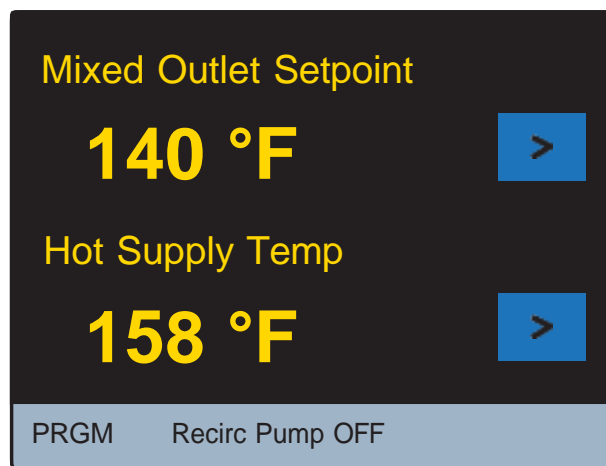

3. If the “Hot Supply Temp” is BELOW the “Mixed Outlet Setpoint”
 - a. Ensure flow is above the minimum rated flow by opening the hot water valve on two to four fixtures being supplied with tempered water from the panel.

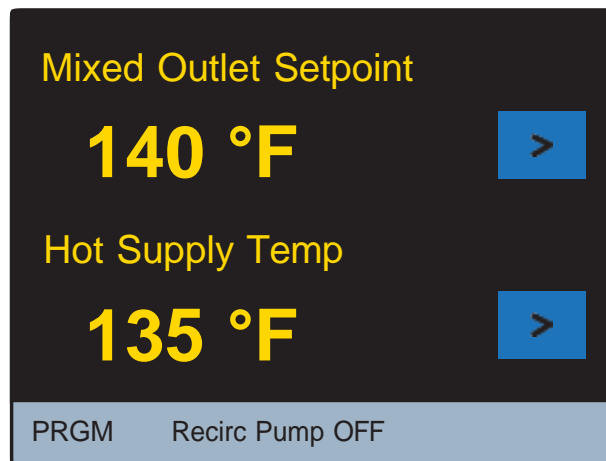

Troubleshooting

b. Ensure that the hot water inlet isolation valve is in the fully Open (ON) position as shown below

Closed (OFF)



Open (ON)



c. Check the hot water source set-point temperature and ensure that the hot supply line has no obstructions or closed valves restricting flow to the ADMS.

4. If the “Hot Supply Temp” is ABOVE the “Mixed Outlet Setpoint”, there are no obstructions preventing hot water from reaching the panel, and there is sufficient flow through the panel, reset the control by pressing the **PRGM** icon to access the “Programming” menu. Unlock the control (see “Unlock the System” of this manual for more detail) and then select the **TOOLBOX** to navigate to the “Toolbox” menu shown below.

Toolbox	
Load Defaults	No
Temperature Units	°F
Flow Units	gpm
Energy Units	MBtu
Pressure Units	psi
Backlight	100 %
Reset	No
Back	Up
Down	Enter
	?

From within the “Toolbox” menu use the **Down** icon to highlight “Reset” as shown above then press **Enter**. This will access the “Reset” menu shown below.

Troubleshooting

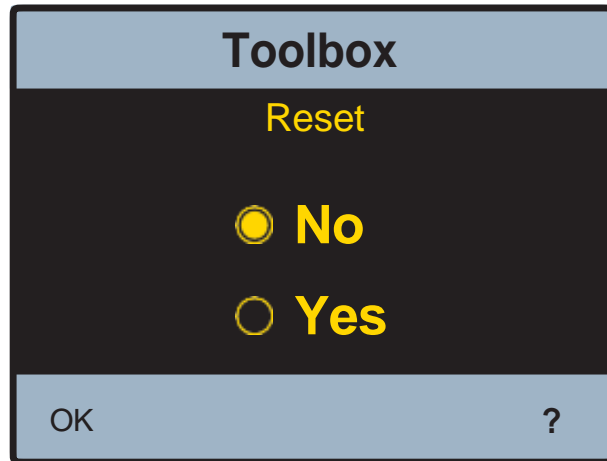

Press the **Yes** and then **OK** and the control will reset and begin a start up sequence.

5. Reset the control by opening and closing the circuit breaker switch and wait 60 seconds to resume normal operation.



Always use proper precautions when accessing circuit breaker box.

NOTICE

If problem persists after conducting the above outlined problem solving procedures, contact AERCO Technical Support at 800-526-0288.

Troubleshooting

Problem: Outlet temperature above set point

Solution:

1. Ensure flow is above the minimum rated flow by opening the hot water valve on two to four fixtures being supplied with tempered water from the panel.
2. Ensure that the cold supply isolation valve is in the fully open position as shown below.

Closed (OFF)



Open (ON)



3. On the Home Screen, check the “Cold Supply Temp” using the  icon (see below) to cycle through the various fields. Ensure that it is lower than the set point temperature and that the cold supply line has no obstructions or closed valves restricting flow to the ADMS.

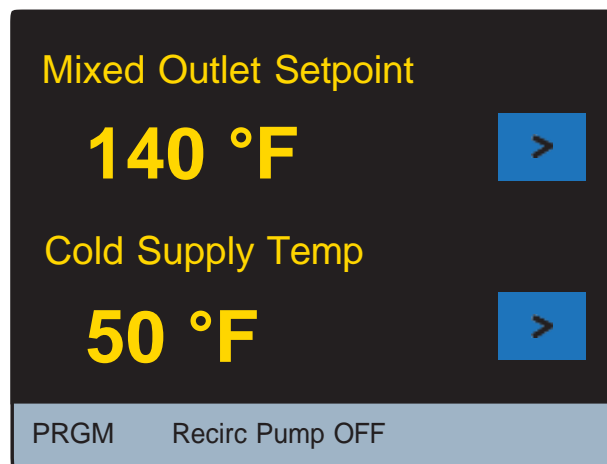

4. Reset the control by opening and closing the circuit breaker switch and wait 60 seconds to resume normal operation.



Always use proper precautions when accessing circuit breaker box.

Troubleshooting

5. Unlock the control (see “Unlock the System” of this Manual for more detail) and then select the **TOOLBOX** to navigate to the “Toolbox” menu shown below.

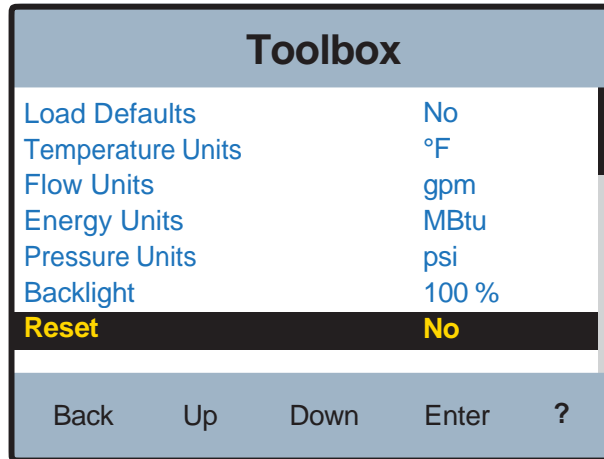

6. On the “Toolbox” menu use the **Down** icon to highlight “Reset” as shown above then press **Enter**. This will access the “Reset” menu shown below.

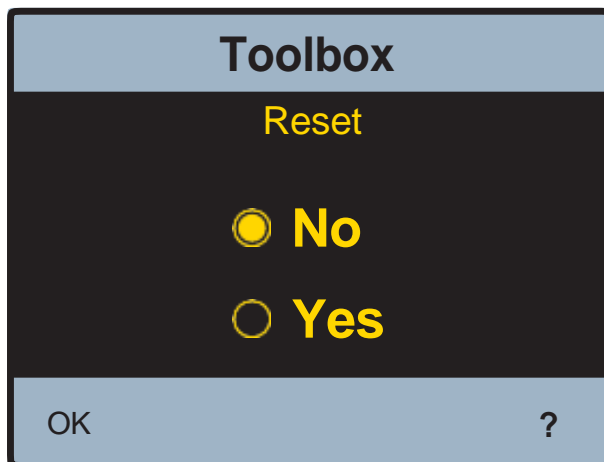

7. Press the **Yes** and then **OK** and the control will reset and begin a start up sequence.
8. Reset the control by opening and closing the circuit breaker switch and wait 60 seconds to resume normal operation.



9. If problem persists after conducting the above outlined problem solving procedures contact AERCO Technical Support at 800-526-0288.



Troubleshooting

Problem: If displays “---” Instead measured value.

Solution:

1. A sensor is not connected or functioning properly.
2. Check the connection at the sensor and the connection within the control module.

! DANGER





BEFORE attempting to open Control Module, a certified and qualified electrician MUST fully de-energize and disconnect all electrical power from ADMS.

Perform required LOCK OUT/TAG OUT procedures.

When done, reconnection and reenergizing of ADMS MUST be performed by certified and qualified electrician.

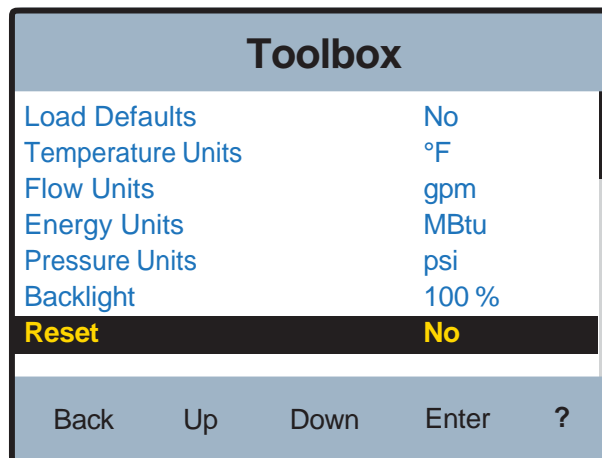
3. Disconnect all power and fully de-energize ADMS BEFORE opening the control module. Open the Control Module and locate the non-functioning sensor.
4. Reset the control by pressing the **PRGM** icon to access the “Programming” menu. Unlock the control (see Detailed User Interface this manual) and then select the **TOOLBOX** to navigate to the “Toolbox” menu shown below.



From within the “Toolbox” menu use the **Down** icon to highlight “Reset” as shown above then press **Enter** . This will access the “Reset” menu shown below.

Troubleshooting

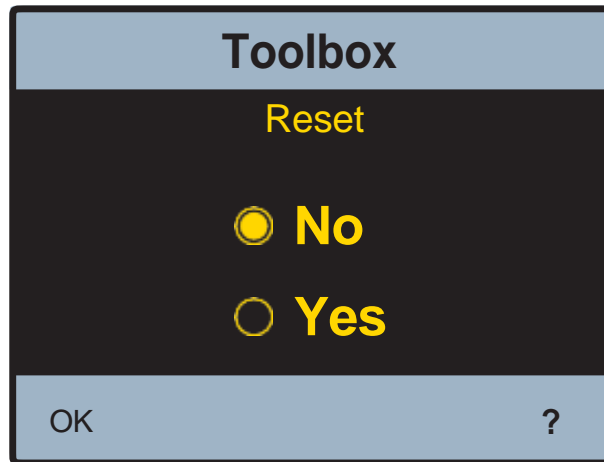

Press the **Yes** and then **OK** and the control will reset and begin a start up sequence.

Note: Alternatively, the control can be reset by opening and closing the circuit breaker switch and waiting 60 seconds to resume normal operation.



Always use proper precautions when accessing circuit breaker box.

5. Wait 1-5 minutes for the control to resume normal operation. Also, ensure that there is a load (at least one tap on the mixed outlet system) present while the control is resuming normal operation.
Note: See "Start-Up" and "Commissioning" procedures of this Manual for more detail.
6. If problem persists after conducting the above outlined problem solving procedure contact AERCO for replacement sensor(s).

Troubleshooting

Error Codes ■

If the control detects a problem, an error will display on the Home screen and from within the “System Monitor” menu. To navigate to the System Monitor” menu press **PRGM** icon, unlock the control (see detailed Unlock instructions in this Manual for more information), and select **MONITOR** from within the “Programming” menu. The “System Monitor Screen” is shown below.

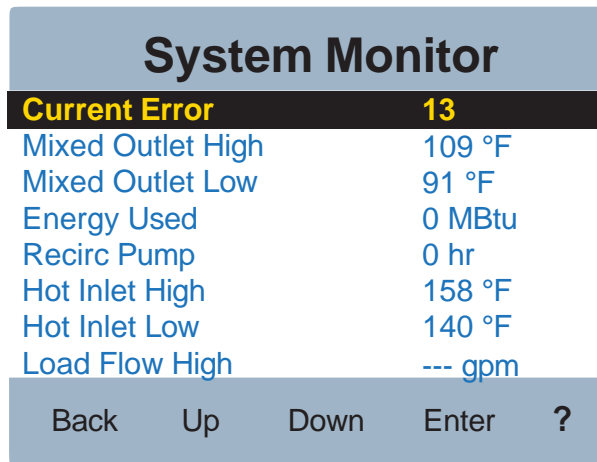

System Monitor	
Current Error	13
Mixed Outlet High	109 °F
Mixed Outlet Low	91 °F
Energy Used	0 MBtu
Recirc Pump	0 hr
Hot Inlet High	158 °F
Hot Inlet Low	140 °F
Load Flow High	--- gpm
Back	Up
Down	Enter ?

The “How to Clear” information presented below is also available from within the control user interface by pressing the **?** key from within the “System Monitor” while viewing the “Current Error”. For more information on navigating and using the user interface see the "control module interface".

Troubleshooting

Hierarchy	Description	Resolution	Control Behavior during Error Condition
1	NVM Error	Load defaults and/or power cycle the control	Do not operate any outputs
2	Faulty Mixed Outlet (T1) sensor	Ensure that the T1 wiring is correct	Do not operate any outputs
3	Faulty Mixed Outlet (FT1) sensor	Ensure that the FT1 wiring is correct	Do not operate any outputs, Do not calculate energy
4	Max Temp Exceeded	-Increase "Mixed Out Maximum" within the "System" settings. -Turn on a tap to cool down the system.	Control Resets
5	Faulty Recirc Return (T2) sensor	Ensure that the T2 wiring is correct	Do not operate recirculation pump, Do not calculate energy
6	Faulty Cold Supply (T3) sensor	Ensure that T3 sensor wiring is correct	Continues operation
7	Faulty Hot Supply (T4) sensor	Ensure that T4 sensor wiring is correct	Continues operation
8	Faulty Mixed Outlet Pressure (P1) sensor	Ensure that P1 sensor wiring is correct	Continues operation
9	Faulty Recirc Return Pressure (P2) sensor	Ensure that P2 sensor wiring is correct	Continues operation
10	Faulty Cold Supply Pressure (P3) sensor	Ensure that P3 sensor wiring is correct	Continues operation
11	Faulty Hot Supply Pressure (P4) sensor	Ensure that P4 sensor wiring is correct	Continues operation
12	Faulty Mixed Outlet Flow (F1) sensor	Ensure that F1 sensor wiring is correct	Do not calculate energy
13	Faulty Recirc Return Flow (F2) sensor	Ensure that F2 sensor wiring is correct	Do not calculate energy

NOTICE

The alert relay is configured to close while an error is occurring. Once the error is cleared the alert relay will open.

Replacement Part Numbers

Replacement Part #	Description
81019285	1 ½ Inch 3 way valve
81019286	2 Inch 3 way valve
81019287	Actuator
81019288	Pressure sensor with wire (P)
81019289	High speed temperature sensor with wire (FT)
88006479	Controller
81019061	Temperature sensor with wire (T)

Scheduled Testing, Inspection and Maintenance

Testing/Inspection ■

WARNING

Need for Periodic Inspection/Maintenance: This product must be tested periodically in compliance with local codes, but at least once per year or more as service conditions warrant. All products must be retested once maintenance has been performed. Corrosive water conditions and/or unauthorized adjustments or repair could render the product ineffective for the service intended. Regular checking and cleaning of the product's internal and external components helps assure maximum life and proper product function.

Scheduled Testing, Inspection and Maintenance

Maintenance ■

■ Actuator and/or Valve Removal

NOTICE

Valves and actuators are not field serviceable. They must be removed and replaced.

Tools Required:

- 10mm and $\frac{3}{8}$ " sockets, elbow and torque wrench. Not required if replacing both valve and actuator
- $\frac{3}{8}$ " wrench. Not required if replacing both valve and actuator
- 2.5mm Allen key. Not required if replacing both valve and actuator
- $\frac{1}{8}$ " (3.2mm, #2) slot screwdriver. Not required for valve only replacement
- Wire Stripper and snips. Not required for valve only replacement
- AC Voltmeter . Not required for valve only replacement
- Five to ten 4" zap straps (cable ties)
- 4" monkey wrenches (gas grips)
- 3" adjustable wrenches (shifting spanner)
- Teflon Tape. Not required for actuator only replacement

■ Actuator Removal Instructions

⚠ DANGER



BEFORE attempting to open Control Module, a certified and qualified electrician MUST fully de-energize and disconnect all electrical power from ADMS.



Perform required LOCK OUT/TAG OUT procedures.

When done, reconnection and reenergizing of ADMS MUST be performed by certified and qualified electrician.

Scheduled Testing, Inspection and Maintenance

1. Once de-energized and disconnected, the display will become inactive and the control box can be opened.



As an additional safety check, once the box is open, confirm that the unit is de-energized by measuring the AC voltage across the “L” and “N” terminals (46 and 45 respectively) using the voltmeter. Alternatively, use a voltage detector to confirm that the unit is **NOT energized.**

2. Using the slot screwdriver loosen terminals 1 to 5 (0-10 Act, Com, Mtr FB, R, C, respectively) in the upper left side of the control module. Take note of the wire colors connected to each of the terminals. This connection should be as follows:
1) Grey, 2) N/A, 3) Pink, 4) Red, 5) Black.

Control Unit (interior)

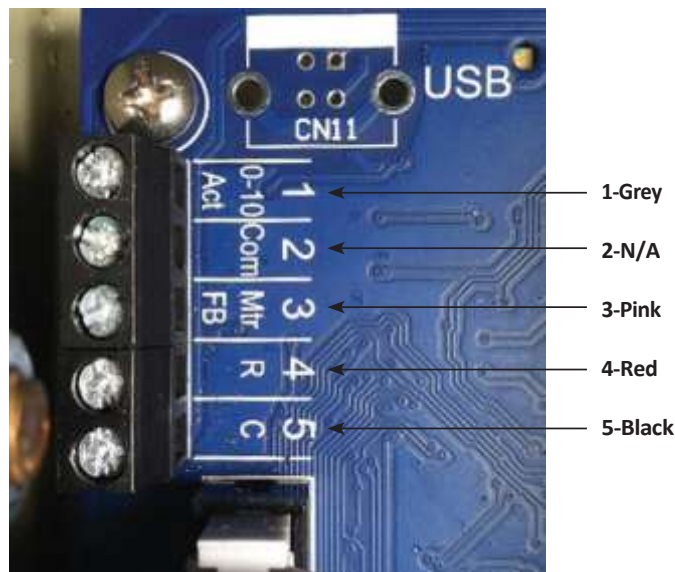

3. Locate the Actuator Cable. Remove the Actuator Cable from the control box and stand supports. If needed, snip cable ties making sure not to damage any other wires when removing the cable ties.
4. Also, note the routing of the actuator cable for reinstallation.
5. Remove the actuator from the valve as follows:
 - a. Using the 3/8" wrench remove the two actuator support plate bolts (see image, p.73)
 - b. Using the 10mm wrench loosen the actuator armature clamping nut (see image, p.73)
 - c. Using the 3/8" wrench completely remove the support plate bolts
 - d. At this point the actuator should be free to slide off the valve stem away from the valve. If not, further loosen the actuator armature clamping nut
 - e. Carefully remove the actuator and set it aside.

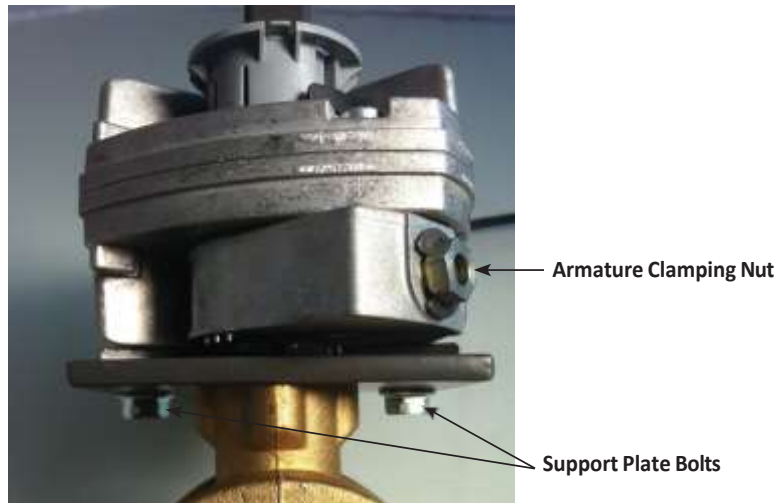

Scheduled Testing, Inspection and Maintenance

Actuator



■ Valve Replacement

⚠ DANGER

BEFORE attempting to open Control Module, a certified and qualified electrician MUST fully de-energize and disconnect all electrical power from ADMS.

Perform required LOCK OUT/TAG OUT procedures.

When done, reconnection and reenergizing of ADMS MUST be performed by certified and qualified electrician.

1. Once de-energized the display will become inactive.
2. If removing only the valve use Step 4 from the "Actuator Removal"
3. Disconnect the pressure sensor (P1) and outlet sensor (FT1). Using a wrench remove the redundant temperature (T1) from the pipe fitting.
4. Using either the shifting spanner or the gas grip loosen the three unions holding the valve in place (see below).

Scheduled Testing, Inspection and Maintenance

Electronically Controlled Valve

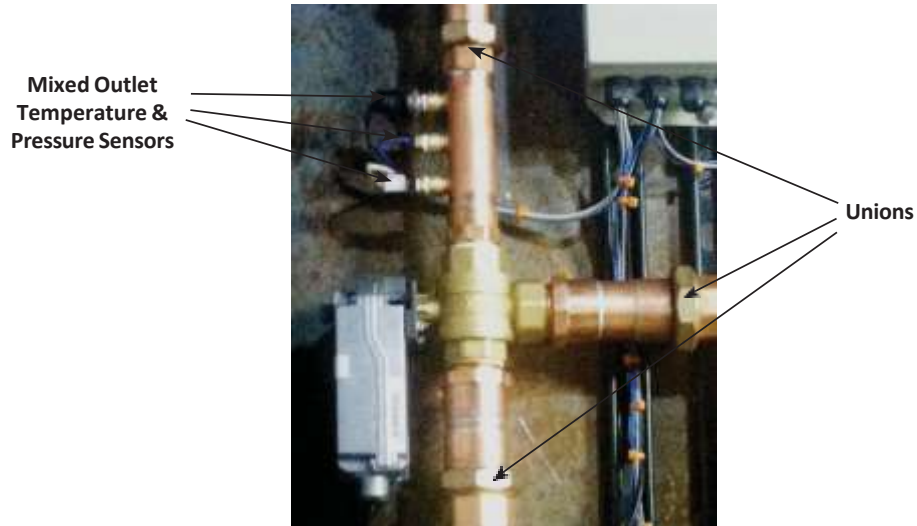

5. If replacing the valve remove the NPT couplers, union fittings, and actuator mounting plate from the old valve and transfer them to the replacement valve for reinstallation.
6. To reinstall the valve simply reverse the above outlined procedure.

NOTICE

If installing Valve and Actuator (V&A) combination, proceed to Step 8 of actuator installation procedure once the V&A have been plumbed back into the stand

■ **Actuator Replacement**

NOTICE

To install a replacement actuator, the positioning of both the actuator and valve needs to be confirmed prior to installation

Scheduled Testing, Inspection and Maintenance

1. The actuator armature must be positioned in the un-powered rest position.
Marked "Correct" in the picture below

Actuator

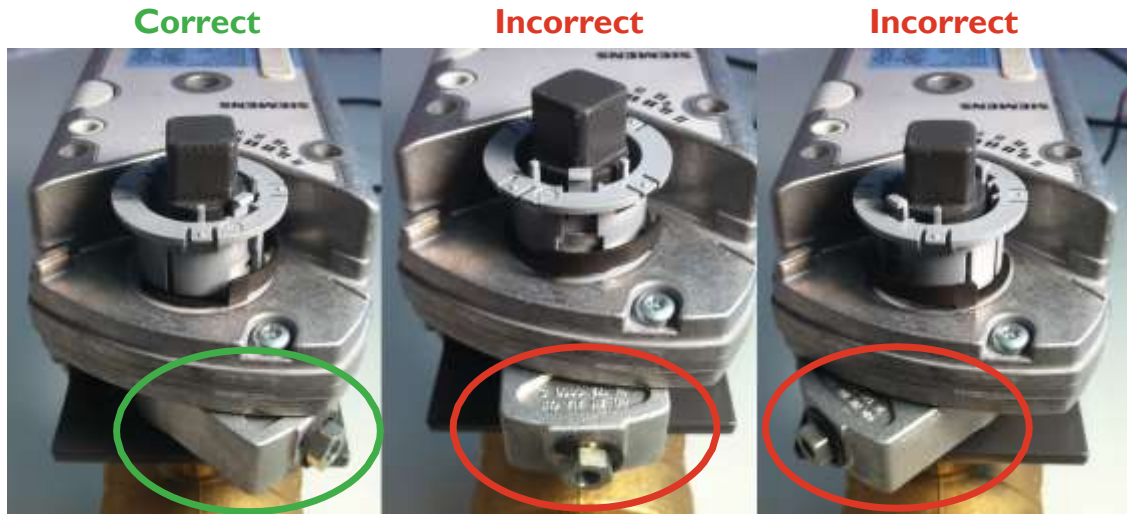

2. To adjust the armature position, depress the actuator manual override button (see below) and turn the armature to the "Correct" position shown above.

Actuator

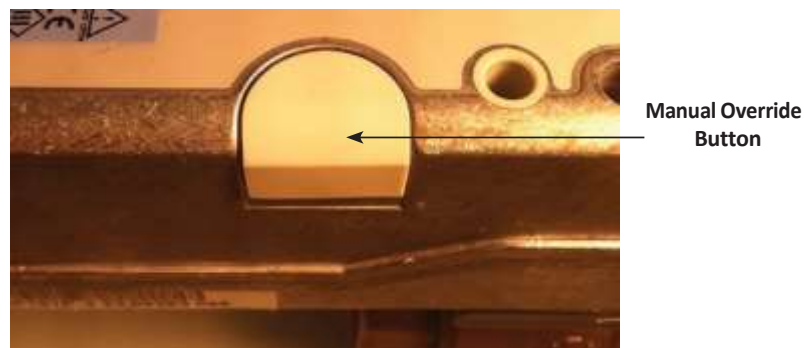

3. The valve must be positioned such that it is fully opened to the branch (cold supply). The "Correct" and "Incorrect" positions are shown below. These images are looking in the outlet port of the valve (note the black plastic flow linearization insert).

NOTICE

When positioned correctly, the valve outlet (plastic insert) will be fully open to the cold inlet side of the valve.

Scheduled Testing, Inspection and Maintenance

Valve Outlet

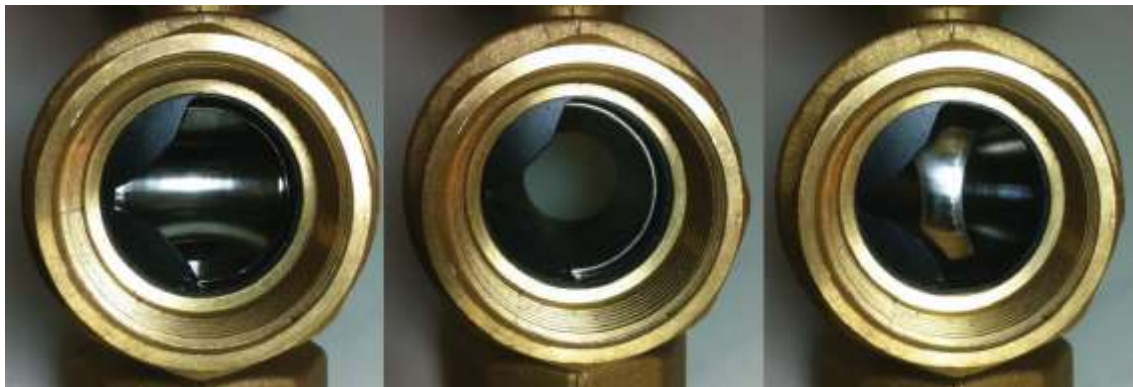

Correct

Incorrect

Incorrect

4. Once both the actuator and valve have been aligned “correctly” the actuator can be reinstalled onto the valve by sliding actuator over the valve stem until the actuator sits tight against the actuator support plate with the actuator positioned vertically as shown below.

NOTICE

The valve outlet (with plastic insert) should be facing upwards

Valve / Actuator



Correct



Incorrect

Scheduled Testing, Inspection and Maintenance

- Using the $\frac{3}{8}$ " wrench, install the support plate bolts (see below) until snug. Ensure that the support plate bolts are sufficiently loose to allow for some very slight movement between the support plate and the actuator. This play will allow the actuator to find the proper position when the armature clamping nut is tightened down.

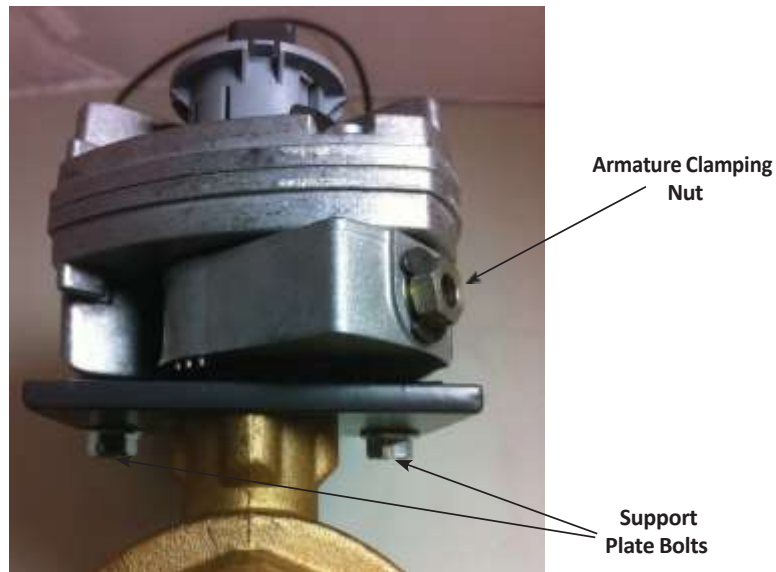

- Tighten down the armature clamping nut using the 10mm socket and torque wrench to 50 in-lbs (5.65 N-m)
- Using the $\frac{3}{8}$ " socket, elbow and torque wrench, torque down the support plate nut to 50 in-lbs.

NOTICE

Take caution not to overtighten and strip these nuts.

Scheduled Testing, Inspection and Maintenance

- 8. Run the control wires up to the control along the same path as when removed.
- 9. Cut wires to an appropriate length and strip to allow for installation into the terminal blocks.
- 10. Wire to terminal blocks as follows:
 - 1. (0-10 Act) Grey
 - 2. (Com) N/A
 - 3. (Mtr FB) Pink
 - 4. (R) Red
 - 5. (C) Black

NOTICE

- The "Com" terminal of the control is not wired & orange actuator wire is not used by this control
- 11. Utilize cable ties to secure the wires and close the control module. Once the box is closed, re-energize the unit.
 - 12. Resume normal operation and observe that the actuator and valve are now working properly.

Control Unit (interior)

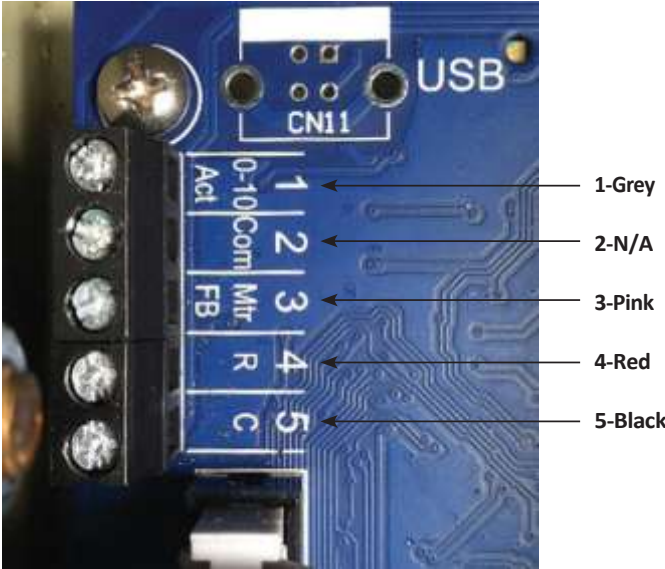



A **WATTS** Brand

100 Oriatani Drive • Blauvelt, NY 10913 • Tel: (800) 526-0288 • aerco.com

OMM-0126-0A

© 2023 AERCO