

# Installation, Operation and Maintenance

## WiFi Thermostat 563

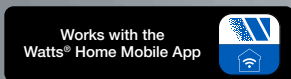
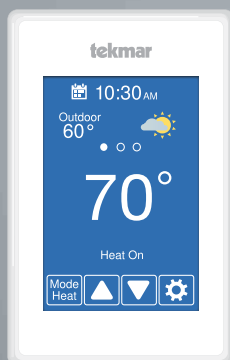

### Compatible With

- Conventional systems:  
2-stage heating, 2-stage cooling, fan and 2 accessories
- Heat pump systems:  
4-stage heating, 2-stage cooling, fan, reversing valve and 1 accessory
- Supports dual fuel systems
- Accessory options:  
Humidifier, dehumidifier, HRV/ERV ventilator, heat pump loop valve

#### ⚠ WARNING



Please read carefully before proceeding with installation. Your failure to follow any attached instructions or operating parameters may lead to the product's failure.  
Keep this Manual for future reference.



**tekmar**<sup>®</sup>  
A WATTS Brand

# Table of Contents

Important Safety Information.....	3
Installation .....	4
Preparation.....	4
Removing The Thermostat Base .....	4
Mounting The Thermostat.....	5
Relay Power Jumpers .....	5
Application 563-1 .....	6
Application 563-2 .....	7
Application 563-3.....	8
Application 563-4.....	9
Sequence of Operation .....	10
Heating and Cooling Operation .....	10
Relative Humidity Operation .....	13
HRV / ERV Ventilator Operation .....	14
Heat Pump Loop Valve Operation .....	14
User Interface.....	15
User Settings.....	16
Away .....	16
Schedule .....	16
Display.....	17
Time.....	18
Fan.....	18
WiFi.....	19
WiFi and Connectivity Troubleshooting.....	20
Installer Settings.....	21
Setup .....	21
Setup - Toolbox.....	21
Setup - Temp.....	22
Setup - Sensors .....	23
Setup - Alerts .....	24
Setup - Relays.....	25-27
Setup - Humidity .....	28
Setup - HRV / ERV Ventilation .....	28
Error Messages .....	29
Technical Data .....	31
Limited Warranty .....	32

# Important Safety Information

It is your responsibility to ensure that this thermostat is safely installed according to all applicable codes and standards. tekmar® is not responsible for damages resulting from improper installation and/or maintenance.



This is a safety-alert symbol. The safety alert symbol is shown alone or used with a signal word (DANGER, WARNING, or CAUTION), a pictorial and/or a safety message to identify hazards.

When you see this symbol alone or with a signal word on your equipment or in this Manual, be alert to the potential for death or serious personal injury.



This pictorial alerts you to electricity, electrocution, and shock hazards.

## **WARNING**

This symbol identifies hazards which, if not avoided, could result in death or serious injury.

## **CAUTION**

This symbol identifies hazards which, if not avoided, could result in minor or moderate injury.

## **NOTICE**

This symbol identifies practices, actions, or failure to act which could result in property damage or damage to the equipment.

## **WARNING**



Read Manual and all product labels BEFORE using the equipment. Do not use unless you know the safe and proper operation of this equipment. Keep this Manual available for easy access by all users. Replacement Manuals are available at [tekmarControls.com](http://tekmarControls.com)

## **WARNING**

- It is the installer's responsibility to ensure that this thermostat is safely installed according to all applicable codes and standards.
- Improper installation and operation of this thermostat could result in damage to the equipment and possibly even personal injury or death.
- This thermostat is not intended for use as a primary limit control. Other controls that are intended and certified as safety limits must be placed into the control circuit.

## **NOTICE**

Do not attempt to service the thermostat. There are no user serviceable parts inside the thermostat. Attempting to do so voids warranty.

# Installation

## Preparation

### Tools Required

- tekmar or jeweler screwdriver
- Phillips head screwdriver
- Wire stripper
- Drill (for wall anchor)
- 3/16" drill bit (for wall anchor)

### Materials Required

- 18 AWG LVT Solid Wire (low voltage connections)

## Installation Location

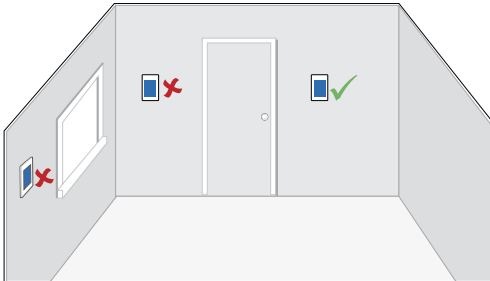

### NOTICE

Consider the following:

- Interior wall.
- Keep dry. Avoid potential leakage onto the control.
- Relative humidity less than 90%. Non-condensing environment.
- No exposure to extreme temperatures beyond 32-122°F (0-50°C).
- No draft, direct sun, or other cause for inaccurate temperature readings.
- Away from equipment, appliances, or other sources of electrical interference.
- Easy access for wiring, viewing, and adjusting the display screen.
- Approximately 5 feet (1.5 m) off the finished floor.
- The maximum length of wire is 500 feet (150 m).
- Strip wire to 3/8" (10 mm) for all terminal connections.
- Use standard 8 conductor, 18 AWG wire.

## Removing the Thermostat Base

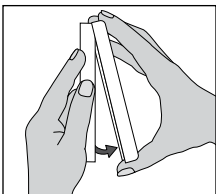

While holding the base section in one hand, pull the lower half of the display front towards you to pivot it away from the base.

# Mounting the Thermostat

## ⚠ WARNING



To prevent the risk of personal injury and/or death, make sure power is not applied to the thermostat until it is fully installed and ready for final testing. All work must be done with power to the circuit being worked on turned off. Please be aware local codes may require this thermostat to be installed or connected by an electrician.

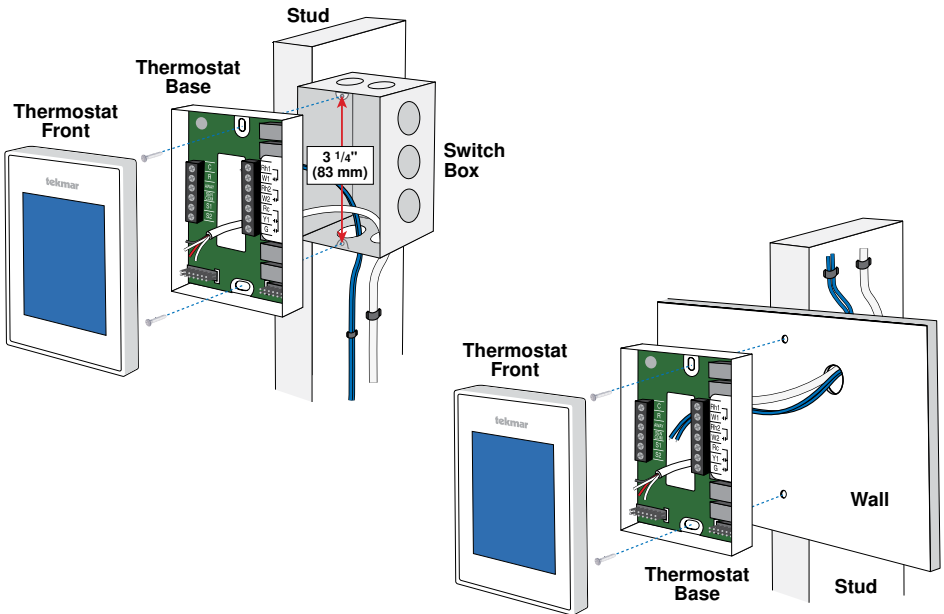

## Relay Power Jumpers

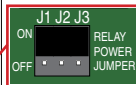
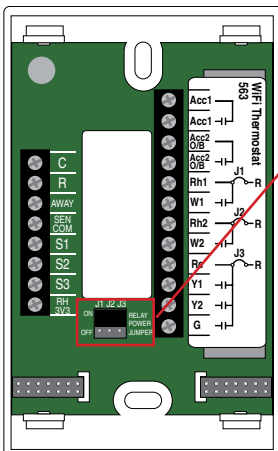

The thermostat includes three relay power jumper connectors located below the wiring hole.

- Set Jumper J1 to On to connect power R to the Rh1 terminal.
- Set Jumper J2 to On to connect power R to the Rh2 wiring terminal.
- Set Jumper J3 to On connects power R to the Rc wiring terminal.
- Set the jumper to off to disconnect the power from Rh1, Rh2, or Rc respectively.

# Application 563-1

The WiFi Thermostat 563 operates a one or two-stage furnace for heating, a one or two-stage air conditioner for cooling, a humidifier, and a heat recovery ventilator.

## Mechanical

### Legend

C1 = Air Conditioner

F1 = Furnace

H1 = Humidifier

HRV = Heat or Energy Recovery Ventilator

S1 = Optional Humidity & Temperature Sensor 086

T1 = WiFi Thermostat 563

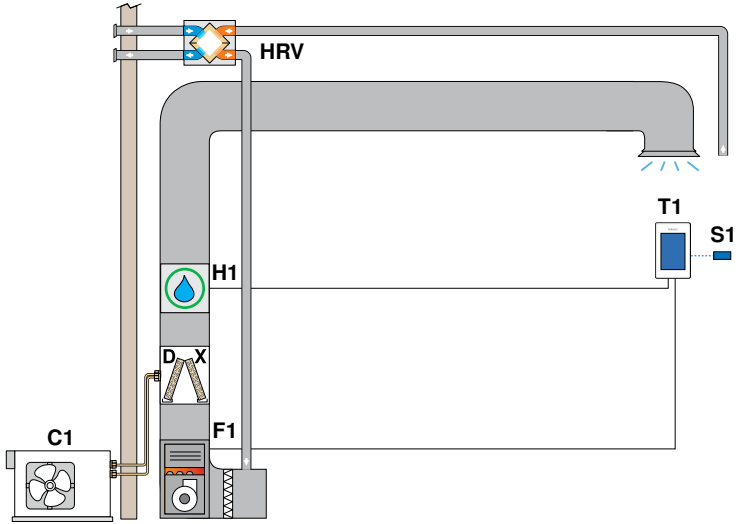

## Electrical

Thermostat

jumpers:

J1 = On

J2 = On

J3 = On

field jumper wire  
from Rh1 to Acc2

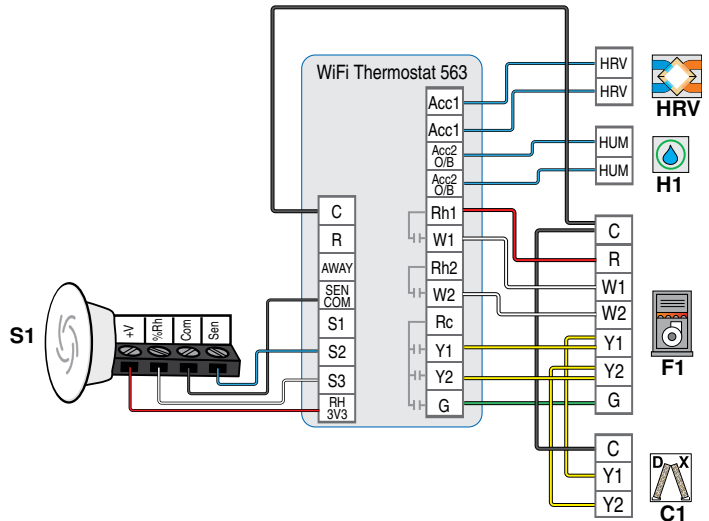
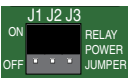

# Application 563-2

The WiFi Thermostat 563 operates a first stage radiant floor and a second stage fan coil for heating, and two-stage air conditioner for cooling and dehumidification, and a humidifier.

## Mechanical

### Legend

B1 = Boiler  
 BP = Boiler Pump  
 C1 = Air Conditioner  
 H1 = Humidifier  
 F1 = Fan Coil  
 PS = System Pump  
 S1 = Optional Slab Sensor 079

S2 = Optional Humidity & Temperature Sensor 086  
 T1 = WiFi Thermostat 563  
 V1 = Radiant Zone Valve  
 V2 = Fan Coil Zone Valve  
 ZVC1 = Zone Valve Control 304V or 306V

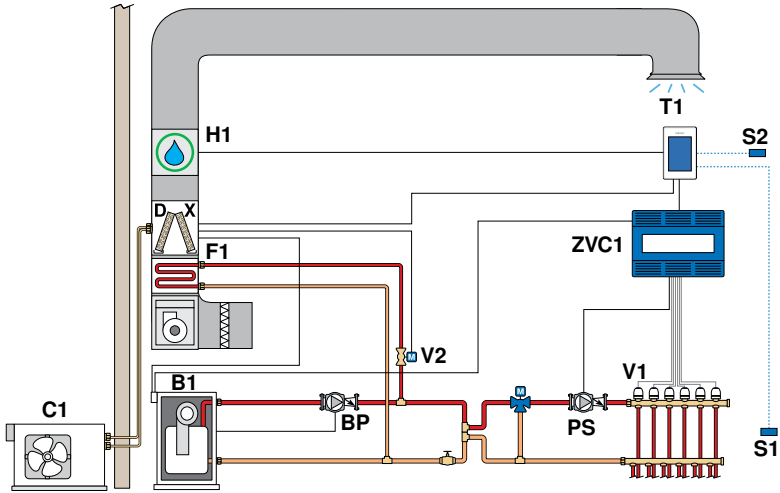

## Electrical

Thermostat jumpers:

J1 = On  
 J2 = Off  
 J3 = Off

and install field jumper wire from Rh2 to Rc and Rh2 to Acc2

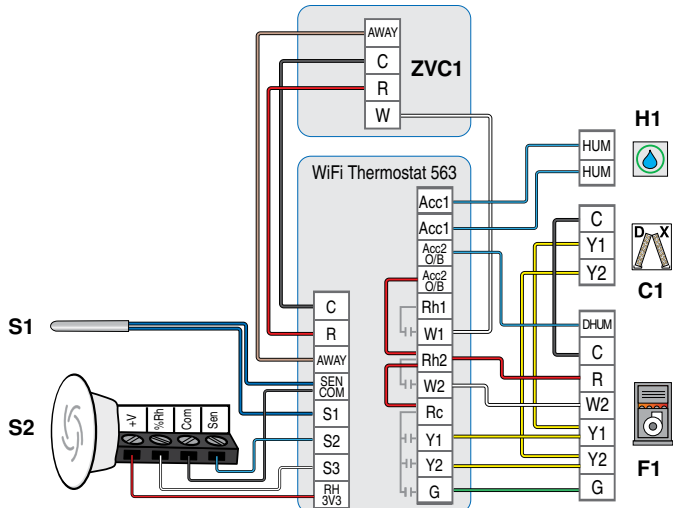
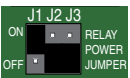

# Application 563-3

The WiFi Thermostat 563 operates a first stage radiant floor and a two-stage air-to-air heat pump for heating, cooling, and dehumidification, a backup electric heater, and a humidifier.

## Mechanical

### Legend

B1 = Boiler  
 BP = Boiler Pump  
 E1 = Electric Strip Heater  
 HP1 = Heat Pump

H1 = Humidifier  
 PS = System Pump  
 S1 = Optional Floor Sensor 079  
 S2 = Optional Humidity & Temperature Sensor 086

T1 = WiFi Thermostat 563  
 V1 = Radiant Zone Valve  
 V2 = Fan Coil Zone Valve  
 ZVC1 = Zone Valve Control 304V or 306V

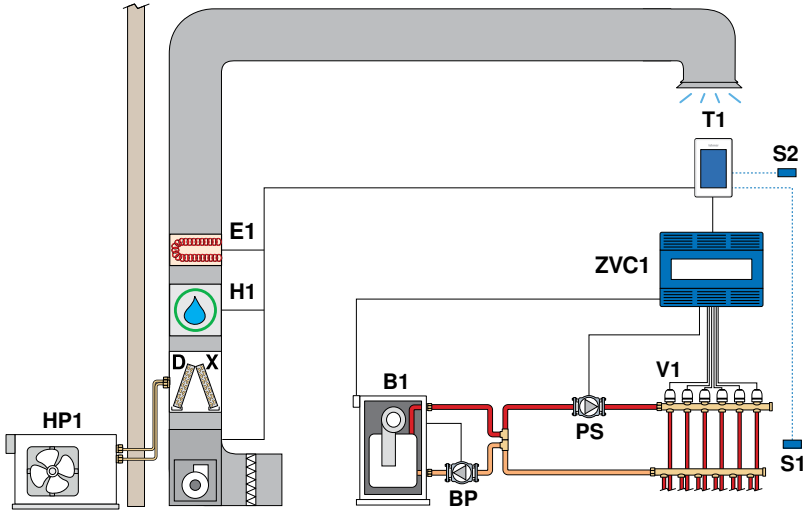

## Electrical

Thermostat jumpers:

J1 = On

J2 = Off

J3 = Off

and install field jumper wire from Rh2 to Rc and Rh2 to Acc2

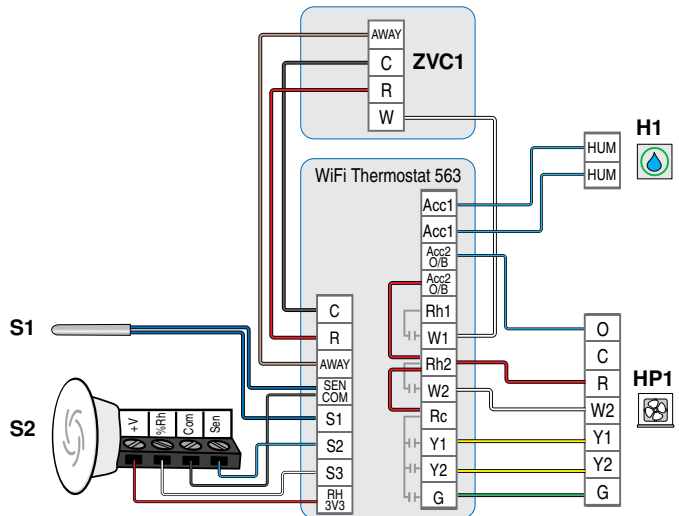
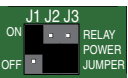



# Application 563-4

The WiFi Thermostat 563 operates a two-stage water-to-air heat pump for heating and cooling. The heat pump absorbs or rejects heat to a hydronic water loop that is heated by a boiler and cooled using a cooling tower to maintain a constant temperature of approximately 70°F (21°C).

## Mechanical

### Legend

B1 = Boiler

C1 = Cooling Tower

BP = Boiler Pump

CP = Cooling Tower Pump

HP1 = Heat Pump

PS = System Pump

T1 = WiFi Thermostat 563

V1 = Heat Pump Loop Valve

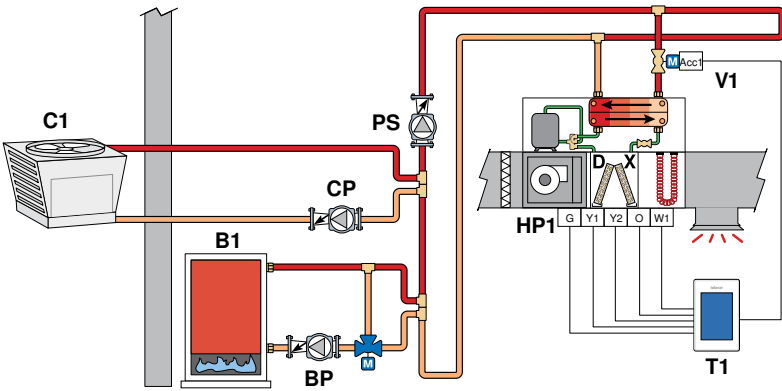

## Electrical

Thermostat  
jumper:

J1 = On

J2 = On

J3 = On

field jumper wire  
from Rh1 to Acc1  
and Rh1 to Acc2

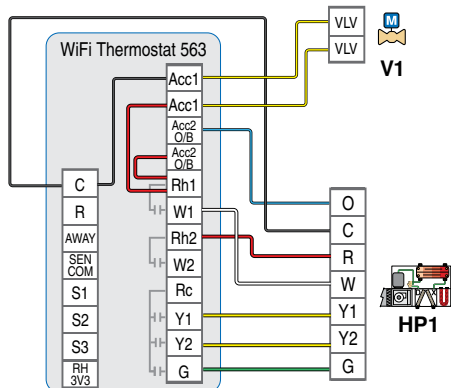
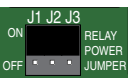

# Sequence of Operation

## Heating Operation

- The heating setpoint can be set from 40 to 95°F (4.5 to 35°C).
- The Heat On symbol is shown on the display when the thermostat is heating.
- Heating for freeze protection is provided whenever the air or floor temperature falls below 40°F (4.5°C), regardless of operating mode.
- The cooling setpoint can be set from 45 to 100°F (7.0 to 38.0°C).
- The Cool On symbol is shown on the display when the thermostat is cooling.

The thermostat supports two heating system types: 1) conventional, or 2) heat pump.

### Conventional Systems

A conventional heating system includes: furnaces, air conditioners, hydronic heating systems with baseboards, radiant floors, or fan coils and electric heating.

The thermostat supports up to two heating stages, two cooling stages, a fan and two accessory relays.

Equipment Setting	1H/1C	1H/2C	2H/1C	2H/2C
First stage heating	W1	W1	W1	W1
Second stage heating	-	-	W2	W2
First stage cooling	Y1	Y1	Y1	Y1
Second stage cooling	-	Y2	-	Y2
Fan	G			
Accessory 1	Choice of: Humidifier, Dehumidifier, HRV/ERV			
Accessory 2	Choice of: Humidifier, Dehumidifier			

### Heat Pump Systems

A heat pump system may include additional heat sources as backup. The thermostat supports up to four heating stages, two cooling stages, a reversing valve, a fan and one accessory relay.

Equipment Setting	1HP	1HP/ 1Aux	1HP/ 2Aux	2HP	2HP/ 1Aux	2HP/ 2Aux
First stage heating	Y1	Y1	Y1	Y1	Y1	Y1
Second stage heating	-	W1	W1	Y2	Y2	Y2
Third stage heating	-	-	W2	-	W1	W1
Fourth stage heating	-	-	-	-	-	W2
First stage cooling	Y1	Y1	Y1	Y1	Y1	Y1
Second stage cooling	-	-	-	Y2	Y2	Y2
Fan	G					
Accessory 1	Choice of: Humidifier, Dehumidifier, HRV/ERV ventilator					
Accessory 2	Reversing valve O relay remains closed during cooling. Reversing valve B relay remains closed during heating.					

When radiant floor heating is installed, it is always the first stage of heating, followed by the heat pump, and lastly any backup heating. This allows the floor to remain warm in the heating season.

Equipment Setting	1HP	1HP/ 1Aux	1HP/ 2Aux	2HP	2HP/ 1Aux	2HP/ 2Aux
First stage heating	Y1	W1	W1	Y1	W1	W1
Second stage heating	-	Y1	Y1	Y2	Y1	Y1
Third stage heating	-	-	W2	-	Y2	Y2
Fourth stage heating	-	-	-	-	-	W2
First stage cooling	Y1	Y1	Y1	Y1	Y1	Y1
Second stage cooling	-	-	-	Y2	Y2	Y2
Fan	G					
Accessory 1	Choice of: Humidifier, Dehumidifier, HRV/ERV ventilator					
Accessory 2	Reversing valve O or B. O relay remains closed during heating operation. B relay remains closed during cooling operation.					

## Emergency Heat

For systems with heat pumps, the thermostat includes an Emergency Heat mode. This mode shuts off the heat pump Y1 and Y2 relays and operates the auxiliary heat, which is usually more expensive. Select Emergency Heat if the heat pump will not operate due to refrigerant pressure lockout condition.

## Heating Differentials

The first stage heat turns on when the air temperature falls 1.5°F (1°C) below the Heat To setting and shuts off when the air temperature reaches the Heat To setting.

The second, third and fourth stage heat each have an adjustable differential and time delay setting to determine when the stage turns on, and shut off when they reach 1.5, 1.0, and 0.5°F (0.75, 0.5, and 0.25°C) of the Heat To setting respectively.

## Radiant Floor Heating

Radiant floor heating is operated differently than other heating types due to the large time delays to heat and cool the slab. When Radiant Floor Heating is selected in the setup menu, the W1 relay operates using Pulse Width Modulation. This improves comfort for radiant systems with high mass floors.

- 100% on time at Heat To setting -1.5°F
- 50% on time at Heat To setting
- 0% on time at Heat To setting + 1.5°F

## Room Sensor and Averaging

The thermostat can measure room temperature between -46 to 212°F (-43 to 100°C). The room temperature can be measured using a combination of the built-in and auxiliary sensors.

- Built-in room sensor only
- Built-in room sensor with auxiliary room sensor(s) (temperature is averaged)
- Auxiliary room sensor only

## **Floor Sensor for Radiant Floor Heating**

The thermostat can measure floor temperature between -46 to 212°F (-43 to 100°C). If a floor sensor is connected, floor minimum and maximum settings are available. The floor heating setpoint is adjustable from 40 to 95°F (4.5 to 35°C).

For a combination of air and floor temperature control, leave the internal air sensor on in the setup menu. A floor minimum can be used to prevent a fast drop in temperature caused by receding solar exposure. This operation is recommended for areas heated by afternoon sun through large windows. When the sun sets, it can take a long time for the floors to get warm again. This may cause the room to cool off too much in the early evening. A floor minimum setting can help with this condition by maintaining a floor minimum temperature. Keep in mind the floor minimum temperature will override the air temperature, and if set too high, may overheat the room.

A floor maximum is recommended for rooms with hardwood floors. Setting floor minimum and maximum temperatures is a way of enhancing the comfort of the living space while protecting floor coverings.

If there are more than one floor temperature sensors, the temperature is averaged.

It's possible to heat a radiant floor while the cooling system is operating. This is desirable in locations such as kitchens and bathrooms. To use this feature, set the Warm Floor During Cooling on.

## **Cooling Differentials**

The first stage cooling turns on when the air temperature rises 1.5°F (1°C) above the Cool To setting and shuts off when the air temperature reaches the Cool To setting.

The second stage cooling has an adjustable differential and time delay setting to determine when the stage turns on, and shuts off when it reaches 0.5°F (0.25°C) above the Cool To setting.

## **Heat Pump Balance Point**

An air source heat pump's Coefficient of Performance (COP) declines with falling outdoor air temperature. The Balance Point is the outdoor temperature at which it is more economical to shut off the heat pump (relays Y1 and Y2) and operate the backup heating equipment (relays W1 and W2).

## **Dual Fuel**

Dual fuel systems include a heat pump together with a backup heat source such as a furnace or a hydronic fan coil. When Dual Fuel is set to on, the heat pump (relays Y1 and Y2) is shut off whenever the backup heating equipment (relays W1 and W2) is operating.

## **Warm Weather Shut Down (WWSD)**

The heating system can automatically shut off based upon the outdoor temperature and the WWSD setting. This provides a convenient way to shut off the heating system.

## **Cold Weather Shut Down (CWSD)**

The cooling system can automatically shut off based upon the outdoor temperature and CWSD setting. This prevents unwanted cooling during the winter.

# Relative Humidity Operation

## Relative Humidity Sensor

The thermostat includes an internal relative humidity (RH) sensor and has the option to connect to an external RH sensor. The installer has the option to disable the internal RH sensor when an external RH sensor is installed. When both the internal and external RH sensors are enabled, the RH reading is averaged.

## Humidifier Operation

The thermostat controls the relative humidity (RH) by operating either the Accessory 1 or Accessory 2 relays. This is an installer configurable setting. When the RH is below the Humidify To setting by 3%, the Accessory 1 or 2 relay is closed to operate a humidifier. The humidifier is shut off when the RH reaches the Humidify To setting.

The thermostat can operate 3 types of humidifiers:

- |             |   |
|-------------|---|
| Stand Alone | <ul style="list-style-type: none"><li>• The humidifier is not connected to the HVAC system.</li><li>• The thermostat Mode can be set to Heat, Cool, Auto or Off.</li></ul>  |
| Steam       | <ul style="list-style-type: none"><li>• The steam humidifier is ducted to the HVAC system.</li><li>• The thermostat Mode can be set to Heat, Cool, Auto or Off.</li><li>• Requires the system fan to turn on when operating.</li></ul>                              |
| Evaporative | <ul style="list-style-type: none"><li>• A drum style humidifier which requires the heating system to operate to evaporate the water.</li><li>• This system requires the system fan to operate.</li><li>• The thermostat Mode must be set to Heat or Auto.</li></ul> |

## Humidifier Window Protection

During cold weather, condensation will form on windows when the relative humidity (RH) is too high. The optional window protection feature automatically calculates the indoor dew point based upon the outdoor temperature and the quality of the windows installed. The humidifier is then operated to the highest possible RH that is below the Humidify To setting. This feature requires a wired connection to an Outdoor Sensor 070.

## Dehumidifier Operation

The thermostat controls the relative humidity (RH) by operating either the Accessory 1 or Accessory 2 relay. This is an installer configurable setting. When the RH is above the Dehumidify To setting by 3%, the Accessory 1 or 2 relay is closed to operate the dehumidifier. The dehumidifier is shut off when the RH reaches the Dehumidify To setting.

The thermostat can operate 2 types of dehumidifiers:

- |             |   |
|-------------|---|
| Stand Alone | <ul style="list-style-type: none"><li>• The dehumidifier is not connected to the HVAC system.</li><li>• The thermostat Mode can be set to Heat, Cool, Auto or Off.</li></ul>  |
| DX Coil     | <ul style="list-style-type: none"><li>• The HVAC cooling system is used for dehumidification.</li><li>• The Accessory 1 or Accessory 2 relay activates the DHUM operation on the air handling unit to operate the system fan at low speed.</li><li>• The cooling compressor Y1 and Y2 relays are operated. The chilled DX coil condenses moisture from the air.</li><li>• The cooling system can over cool the room temperature by 2°F (1°C) during dehumidification.</li></ul> |

## HRV / ERV Ventilator Operation

Ventilation with fresh outdoor air is important for maintaining indoor air quality. The thermostat can operate a heat recovery ventilator (HRV) or energy recovery ventilator (ERV) on a timer by closing the Accessory 1 relay to operate the ventilator fan at low speed.

## Heat Pump Loop Valve Operation

The thermostat supports water-to-air heat pump systems that absorb or reject heat to a hydronic building loop. Whenever the heat pump compressor Y1 or Y2 relay is turned on, the Accessory 1 relay closes to open a hydronic zone valve. This allows variable speed pumps on the hydronic loop to operate at lower speeds when the heat pump is off, thereby saving electrical energy.

# User Interface

After 60 seconds of inactivity, the thermostat home screen displays only the time and the temperature.

Go to schedule

Swipe to view:

- Weather
- Outdoor temperature
- Floor temperature
- Heat To setting
- Cool To setting
- Relative Humidity

Humidifier or Dehumidifier operation

Change operating mode

Current time

Current temperature

Equipment operation Heat, Cool and Fan On

Go to settings

Mode

Emergency Heat

Heat

Cool

Auto Heat-Cool

Off

Save Cancel

Touch ▲ or ▼ to adjust temperatures

Select either Heat To or Cool To

Temperature Adjustment

Heat To 70

Cool To 75

Hold Until 5:00 PM

Save to Schedule

MENU SELECTION

AWAY SCHEDULE

DISPLAY TIME

WIFI SETUP

← FAN

WIFI: Connected

Hold overrides the programmed schedule until the time shown

'Save to schedule' applies the new temperature to the current schedule event.

# User Settings

## Away

Use the Away setting to save energy when the building is unoccupied

Operates normally  
Operates using the Away temperature selected in the Setup menu

- Selecting the Away setting on a thermostat or the mobile app will affect all devices linked to that location through the app.

- The Away temperature can be adjusted in the Setup / Temps menu.

## Schedule

Current group of program days.

Go to the next group of program days.

Heating temperature

Cooling temperature

Early Start anticipates the time required to heat or cool a room and starts early.

Set to On to follow the schedule. Set to Off to use the same temperature all of the time.

Creates a new schedule.

Set schedule start time

Set heating temperature

Set cooling temperature

Select skip if you don't want a temperature change.



# Display

Setting	Range	Default
<b>TEMPERATURE UNITS</b> Select °F or °C.	°F or °C	°F
<b>ENERGY USE</b> View the number of hours the heating or cooling has operated either daily or monthly.	0 to 24 (daily) 0 to 744 (monthly)	0 hours

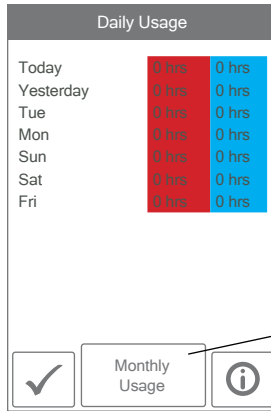

View each day's run time for both heating and cooling.

Toggle between Daily and Monthly Usage.

Setting	Range	Default
<b>BRIGHTNESS ACTIVE</b> Select the brightness when touching the screen.	30 to 100%	100%
<b>BRIGHTNESS INACTIVE</b> Select the brightness when not in use.	Off, 30 to 100%	50%
<b>BACKGROUND</b> Select the background color.	Light, Blue, Night, Latte, Espresso	Blue
<b>LANGUAGE</b> Select the language.	English, Español, Français	English
<b>SCREEN CLEAN</b> Locks screen for 10 seconds to allow cleaning.	N/A	N/A
<b>INACTIVE TIME DISPLAY</b> Select if the time is visible when the display is inactive.	Off or On	On
<b>INACTIVE HUMIDITY DISPLAY</b> Select if the humidity is visible when the display is inactive.	Off or On	Off
<b>INACTIVE OUTDOOR DISPLAY</b> Select if the outdoor temperature is visible when the display is inactive.	Off or On	Off

# Time

When connected to the Internet, the time can be set automatically.

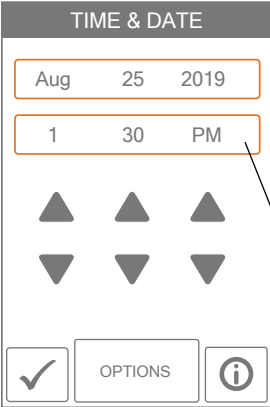

**NOTICE**

Incorrectly setting the time and date manually may prevent the thermostat from communicating to the mobile app. Automatic time source is recommended when using an Internet connection.

The time and date can be manually set by highlighting a field and then using the ▲ or ▼ buttons.

Choose from the time options listed below.

Setting	Range	Default
<b>TIME FORMAT</b> Select the time format.	12 or 24 hour	12 hour
<b>TIME SOURCE</b> If Internet is available, the time source can be either automatically or manually set.	Automatic, Manual	Auto
<b>TIME ZONE</b> Select the local time zone.	Hawaii, Alaska, Pacific, Mountain, Central, Eastern, Atlantic, Newfoundland	Eastern
<b>DAYLIGHT SAVING TIME</b> Select the brightness when not in use.	Off, On	On

# Fan

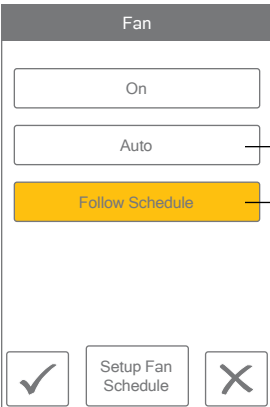

The fan is normally off when set to auto but turns on when needed for the heating or cooling equipment.

When a programmable schedule is used, there is a fan setting for each time period.

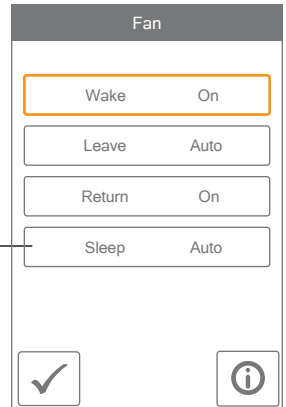

# WiFi

## NOTICE

Before using the WiFi features of this product, you must accept the Terms of Use, as amended from time to time and available at [Watts.com/terms-of-use](https://www.watts.com/terms-of-use). If you do not accept these terms, this product can still be used without WiFi features.

The thermostat includes a step by step tutorial to setup the WiFi connection.

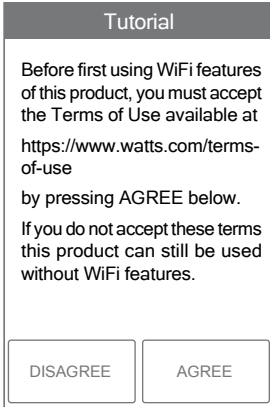

**Tutorial**

Before first using WiFi features of this product, you must accept the Terms of Use available at <https://www.watts.com/terms-of-use> by pressing AGREE below.

If you do not accept these terms this product can still be used without WiFi features.

DISAGREE    AGREE

### Step 1

Agree to Terms of Use

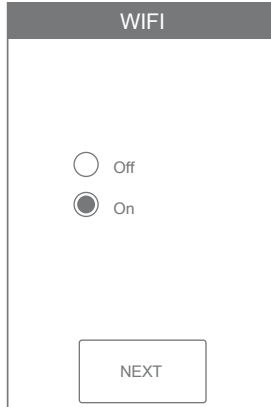

**WiFi**

Off

On

NEXT

### Step 2

Turn on WiFi

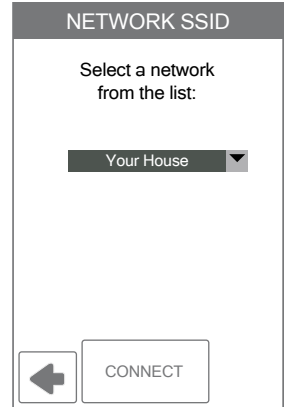

**NETWORK SSID**

Select a network from the list:

Your House ▼

←    CONNECT

### Step 3

Enter wireless network name. It must support WPA2 security encryption.

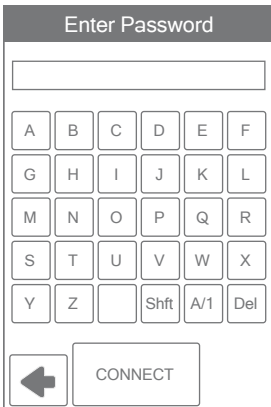

**Enter Password**

\_\_\_\_\_

A	B	C	D	E	F
G	H	I	J	K	L
M	N	O	P	Q	R
S	T	U	V	W	X
Y	Z		Shft	A/1	Del

←    CONNECT

### Step 4

Enter WiFi password.

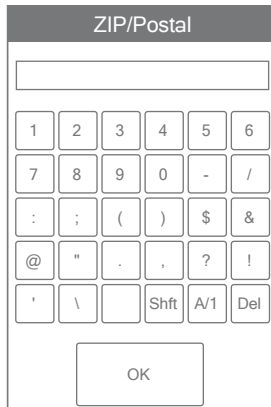

**ZIP/Postal**

\_\_\_\_\_

1	2	3	4	5	6
7	8	9	0	-	/
:	;	(	)	\$	&
@	"	.	,	?	!
'	\		Shft	A/1	Del

OK

### Step 5

Enter ZIP or postal code. This determines your location for weather information.

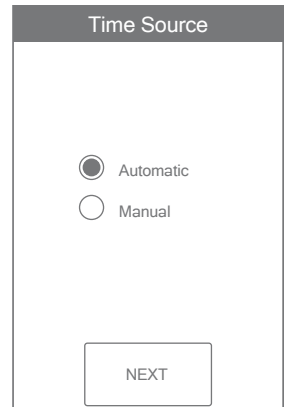

**Time Source**

Automatic

Manual

NEXT

### Step 6

Select if the time is set automatically from the Internet or manually.

# WiFi and Connectivity Troubleshooting

## WiFi Connection Status

Press  > WiFi > WiFi:On > ⓘ to view the thermostat connection status.

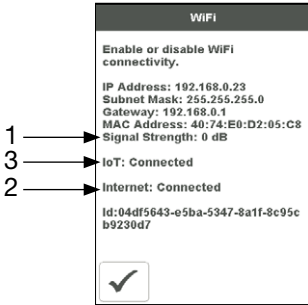

### (1) WiFi Signal Strength

- The WiFi signal must measure between 0 and -69 dB to have a reliable connection to the Watts® cloud.
- A WiFi extender is recommended to be installed if the WiFi signal is between -70 to -100 dB.

### (2) Internet Connected

- The WiFi information screen will show Internet Connected when the thermostat is connected to the router and there is a connection to the Internet.

### (3) IoT Connected

- The thermostat connection status will show IoT Connected when connected to the Watts Cloud and the thermostat is ready to be registered to the app.

If IoT is not connected, please follow these steps:

## Check Password

- Double check that you are using the correct WiFi network and password.
- The password is limited to 32 characters, and can include upper and lower case letters, numbers, special characters and spaces. A space counts as a character.
- The thermostat supports WPA2-Personal password security.

## Power Off and On

- Power the thermostat off. Next, power the router off, wait 10 seconds, then power on and wait for the Internet status to be on. Then power the thermostat on.

## Check Router & Firewall

Consult the router manual or Internet Service Provider (ISP) for assistance with router setup with these configurations:

- The router must provide a 2.4 GHz signal. The thermostat is not compatible with 5 GHz networks.
- The router is using WPA2-Personal security.
- The router has DHCP enabled with enough available addresses for all Internet devices.
- The router firewall is not blocking the outbound UDP or TCP ports: 53, 123, 443, 8883.
- The router firewall is not blocking connections to \*.azure-devices.net
- The router firewall is not blocking the thermostat based upon a MAC filter list.

## Network Troubleshooting

- tekmar provides free access to a network troubleshooting tool called **RouteThis Helps**.
- Download the app from the App Store or Google Play Store to your mobile device.
- Enter code “TEKM” and click “Network scan”. The app will provide further instructions.

## Create a WiFi Hotspot

- If you are unable to connect to the WiFi network, try creating a WiFi Hotspot on your mobile device to bypass the router.
- Apple\* iOS WiFi hotspot instructions <https://support.apple.com/en-us/HT204023>
- Android\*\* WiFi hotspot instructions <https://support.google.com/android/answer/9059108>
- If the thermostat displays IoT connected when using the WiFi Hotspot, please contact your Internet Service Provider (ISP) or IT professional for assistance with the router.

\* Apple and App Store are trademarks of Apple Inc.

\*\* Google, Android and Google Play are trademarks of Google LLC.

# Installer Settings

## Setup

The Setup menu contains seven sub-menus that determine how the thermostat operates.

The Access Level setting in the Toolbox menu determines how many settings are available to the user.

Press back to return to the main Settings menu.

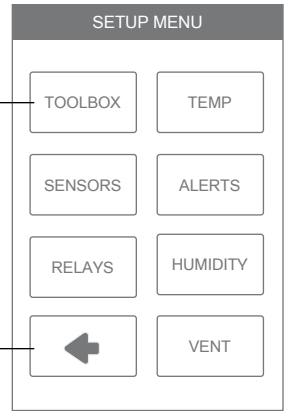

## Setup - Toolbox

Setting	Range	Default
<b>ERROR</b> Displays any error messages.	N/A	N/A
<b>ACCESS LEVEL</b> Select between user and installer access levels. User access level restricts access in the Setup Menu.	User, Installer	Installer
<b>STATUS</b> The current status of warm weather shut down, cold weather shut down and each of the relays.	Early Start, WWSD, CWSD, W1, W2, Y1, Y2, G, Acc1, Acc2	N/A
<b>SOFTWARE VERSION</b> Display the software version.	N/A	N/A
<b>LOAD DEFAULTS</b> All settings are returned to factory defaults.	Yes, No	No
<b>CALIBRATE TOUCHSCREEN</b> Recalibrate the screen after loading factory defaults.	N/A	N/A

# Setup - Temp

Setting	Range	Default
<i>Screen Page 1</i>		
<b>FLOOR MIN - WAKE</b> Select the floor temperature while in the wake schedule. Applies when there is both a floor and an air sensor.	Off, 40 to 95°F Off, 4.5 to 35.0°C	Off
<b>FLOOR MIN - LEAVE</b> Select the floor temperature while in the leave schedule. Applies when there is both a floor and an air sensor.	Off, 40 to 95°F Off, 4.5 to 35.0°C	Off
<b>FLOOR MIN - RETURN</b> Select the floor temperature while in the return schedule. Applies when there is both a floor and an air sensor.	Off, 40 to 95°F Off, 4.5 to 35.0°C	Off
<b>FLOOR MIN - SLEEP</b> Select the floor temperature while in the sleep schedule. Applies when there is both a floor and an air sensor.	Off, 40 to 95°F Off, 4.5 to 35.0°C	Off
<b>FLOOR MIN - AWAY</b> Select the floor temperature while in away. Applies when there is both a floor and an air sensor.	Off, 40 to 95°F Off, 4.5 to 35.0°C	Off
<b>FLOOR MAX</b> Select the maximum floor temperature. This protects the floor covering from over heating. Applies when there is a floor sensor.	Off, 40 to 95°F Off, 4.5 to 35.0°C	Off
<i>Screen Page 2</i>		
<b>HEAT TO AWAY</b> Select the heating temperature when away.	Off, 40 to 95°F Off, 4.5 to 35.0°C	62°F 16.5°C
<b>HEAT TO MIN LIMIT</b> Select the minimum heating temperature limit.	Off, 40 to 95°F Off, 4.5 to 35.0°C	Off
<b>HEAT TO MAX LIMIT</b> Select the maximum heating temperature limit.	Off, 40 to 95°F Off, 4.5 to 35.0°C	Off
<b>COOL TO AWAY</b> Select the cooling temperature when away.	Off, 45 to 100°F Off, 7.0 to 38.0°C	Off
<b>COOL TO MIN LIMIT</b> Select the minimum cooling temperature limit.	Off, 45 to 100°F Off, 7.0 to 38.0°C	Off
<b>COOL TO MAX LIMIT</b> Select the maximum cooling temperature limit.	Off, 45 to 100°F Off, 7.0 to 38.0°C	Off
<i>Screen Page 3</i>		
<b>WARM WEATHER SHUT DOWN</b> Select the outdoor temperature at which the heating is shut off.	Off, 40 to 100°F Off, 4.5 to 38.0°C	Off
<b>COLD WEATHER SHUT DOWN</b> Select the outdoor temperature at which the cooling is shut off.	Off, 40 to 100°F Off, 4.5 to 38.0°C	Off
<b>HEAT PUMP BALANCE POINT</b> Select the outdoor temperature at which the heat pump is shut off and the backup heat source is operated exclusively.	Off, -22 to 70°F Off, -30.0 to 21.0°C	Off

# Setup - Sensors

Setting	Range	Default
<b>SENSOR 1</b> Select the type of sensor connected to S1 and Com wiring terminals.	Off, Room, Floor	Off
<b>SENSOR 2</b> Select the type of sensor connected to S2 and Com wiring terminals.	Off, Room, Floor, Outdoor	Off
<b>SENSOR 3</b> Select the type of sensor connected to S3 and Com wiring terminals.	Off, Room, Floor, Humidity	Off
<b>INTERNAL ROOM SENSOR</b> Select if the internal room temperature sensor is on or off. Only available when Sensor 1, 2 or 3 is set to read a room or floor sensor.	Off, On	On
<b>INTERNAL HUMIDITY SENSOR</b> Select if the internal humidity sensor is on or off. Only available when Sensor 3 is set to read an external humidity sensor.	Off, On	On
<b>ROOM OFFSET</b> Manual offset correction of the room temperature measurement.	Off, -5 to +5°F -3.0 to 3.0°C	Off
<b>FLOOR OFFSET</b> Manual offset correction of the floor temperature measurement.	Off, -5 to +5°F -3.0 to 3.0°C	Off
<b>HUMIDITY OFFSET</b> Manual offset correction of the relative humidity measurement.	Off, -10% to +10%	Off

## Setup - Alerts

Setting	Range	Default
<b>ROOM HOT WARNING</b> Sends an email notification if the room exceeds this temperature.	Off, 40 to 100°F Off, 4.5 to 38.0°C	Off
<b>ROOM COLD WARNING</b> Sends an email notification if the room falls below this temperature.	Off, 40 to 100°F Off, 4.5 to 38.0°C	Off
<b>LOW HUMIDITY WARNING</b> Sends an email notification if the humidity falls below this setting.	Off, 5 to 95%	Off
<b>HIGH HUMIDITY WARNING</b> Sends an email notification if the humidity rises above this setting.	Off, 5 to 95%	Off
<b>AUXILIARY HEAT RUN TIME WARNING</b> Sends an email notification if the auxiliary heat W1 or W2 runs continuously for longer than this setting. This setting only applies for heat pump systems.	Off, 1 to 24 hours	Off
<b>AIR FILTER CHANGE WARNING</b> Sends an email notification to change the air filter when the fan exceeds this run time.	Off, 200 to 2000 hours	Off
<b>UV LAMP CHANGE WARNING</b> Sends an email notification to change the UV disinfectant lamp when it exceeds this run time.	Off, 10,000 to 50,000 hours	Off



## Setup - Relays (1 of 3)

Setting	Range	Default
<b>HEATING TYPE</b> Select between conventional heating or heat pump.	Conventional, Heat Pump	Conventional
<b>EQUIPMENT</b> Select the number of stages of the heating and cooling equipment.	<b>Conventional</b> 1 Heat/1 Cool, 1 Heat/2 Cool, 2 Heat/1 Cool, 2 Heat/2 Cool,	1 Heat/ 1 Cool
	<b>Heat Pump</b> 1 HP, 1 HP/1 Aux, 1 HP/2 Aux, 2 HP, 2 HP/1 Aux, 2 HP/2 Aux	1 HP/1 Aux
<b>RADIANT FLOOR HEATING</b> Select if the first stage W1 heats a radiant floor.	Yes or No	Yes
<b>HEAT 1 DIFFERENTIAL</b> Select when the first stage heating turns on. Turn on point is the Heat To setting minus the differential.	0.9 to 2.0°F 0.5 to 1.05°C	1.4°F 0.75°C
<b>HEAT 2 DIFFERENTIAL</b> Select when the second stage heating turns on. Turn on point is the Heat To setting minus the differential.	1.0 to 10.0°F 0.6 to 5.6°C	2.0°F 1.2°C
<b>HEAT 2 DELAY</b> Select the time delay when the second stage heating turns on. The time delay starts counting after the first stage heating is turned on. This setting is available when there are at least 2 heating stages.	0 to 180 minutes	1 minute
<b>HEAT 3 DIFFERENTIAL</b> Select when the third stage heating turns on. Turn on point is the Heat To setting minus the differential. This setting is available when a heat pump is selected and there are at least 3 heating stages.	1.0 to 10.0°F 0.6 to 5.6°C	2.5°F 1.4°C
<b>HEAT 3 DELAY</b> Select the time delay when the third stage heating turns on. The time delay starts counting after the second stage heating is turned on. This setting is available when a heat pump is selected and there are at least 3 heating stages.	0 to 180 minutes	1 minute
<b>HEAT 4 DIFFERENTIAL</b> Select when the fourth stage heating turns on. Turn on point is the Heat To setting minus the differential. This setting is available when a heat pump is selected and there are 4 heating stages.	1.0 to 10.0°F 0.6 to 5.6°C	3.0°F 1.8°C

## Setup - Relays (2 of 3)

Setting	Range	Default
<b>HEAT 4 DELAY</b> Select the time delay when the fourth stage heating turns on. The time delay starts counting after the third stage heating is turned on. This setting is available when a heat pump is selected and there are at least 4 heating stages.	0 to 180 minutes	1 minute
<b>COOL 1 DIFFERENTIAL</b> Select when the first stage cooling turns on. Turn on point is the Cool To setting plus the differential.	0.9 to 2.0°F 0.5 to 1.05°C	1.4°F 0.75°C
<b>COOL 2 DIFFERENTIAL</b> Select when the second stage cooling turns on. Turn on point is the Cool To setting plus the differential. This setting is available when there are two cooling stages.	1.0 to 10.0°F 0.6 to 5.6°C	2.0°F 1.2°C
<b>COOL 2 DELAY</b> Select the time delay when the second stage cooling turns on. The delay time starts counting after the first stage cooling is turned on. This setting is available when there are two cooling stages.	0 to 180 minutes	1 minute
<b>Y MIN RUN TIME</b> Select the minimum time the cooling compressor must run before shutting off. This helps prevent compressor failure.	0:30 to 10:00 minutes	2:00 minutes
<b>Y MIN OFF TIME</b> Select the minimum time the cooling compressor must be off before turning back on. This helps prevent compressor failure.	0:30 to 10:00 minutes	5:00 minutes
<b>DUAL FUEL</b> Select dual fuel on if the heat pump has 100% backup using a furnace or hydronic fan coil. The setting is available for heat pump systems with auxiliary heat.	Off or On	Off
<b>ACCESSORY RELAY 1</b> Select the type of equipment that the accessory relay 1 operates.	Off, Humidifier, Dehumidifier, Ventilation, HP Loop Valve	Off
<b>ACCESSORY RELAY 2</b> Select the type of equipment that the accessory relay 2 operates. This setting is only available for conventional heating systems.	Off, Humidifier, Dehumidifier	Off
<b>HEAT PUMP REVERSING VALVE</b> Select O for heat pumps designed for normally heating operation. Select B for heat pumps designed for normally cooling operation. This setting is only available for heat pump systems.	O (Orange), B (Blue)	O

## Setup - Relays (3 of 3)

Setting	Range	Default
<p><b>FAN RELAY</b> Select which relays require fan operation. Combinations with W1 are not available when Radiant Floor Heating is set to yes.</p>	<p>G only, With Y With Y and W1, With Y and W2, With Y, W1 and W2</p>	G only
<p><b>FAN WITH HRV/ERV</b> Select if the HVAC system fan should turn on together with the HRV or ERV ventilation fan.</p>	Off or On	Off
<p><b>HUMIDIFIER TYPE</b> Select the type of humidifier. This setting is available when Accessory 1 or 2 is set to Humidifier.</p>	Evaporative, Steam, Stand Alone	Steam
<p><b>WINDOW PROTECTION</b> Select if the relative humidity setpoint should automatically adjust with outdoor temperature to prevent frost on windows. This setting is available when Accessory 1 or 2 is set to Humidifier and an outdoor sensor 070 is wired to the auxiliary sensor.</p>	Off or On	Off
<p><b>WINDOW QUALITY</b> The window quality determines the amount that the relative humidity setting is lowered during cold outdoor weather. Choose the highest number of panes installed and best quality as a starting point. If window condensation appears, lower the setting until condensation stops forming. This setting is available when Accessory 1 or 2 is set to Humidifier and an outdoor sensor 070 is wired to the auxiliary sensor.</p>	<p>1 Pane 2 Pane 3 Pane</p> <p>Poor Average Better</p>	<p>2 Pane Average</p>
<p><b>DEHUMIDIFIER TYPE</b> Select the type of dehumidifier. This setting is available when Accessory 1 or 2 is set to Dehumidifier.</p>	DX Coil, Stand Alone	DX Coil
<p><b>HEAT-COOL TIME INTERLOCK</b> When operating in Mode Auto, select the amount of time to wait between switching from heating to cooling and vice versa.</p>	10 to 180 minutes	10 minutes
<p><b>WARM FLOOR DURING COOLING</b> Select whether the floor should be heated when in cooling mode. This setting is only available when Radiant Floor Heating is set to yes.</p>	Yes or No	No

# Setup - Humidity

Set the lowest relative humidity level.

Range is 10 to 80%

Default is 40%

Available when Accessory 1 or 2 operates a humidifier.

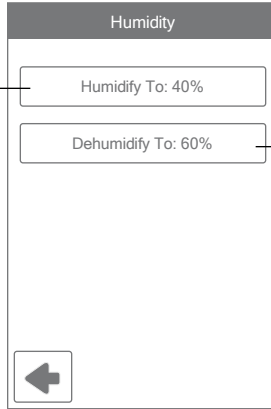

Set the highest relative humidity level.

Range is 20 to 90%

Default is 60%

Available when Accessory 1 or 2 operates a dehumidifier.

# Setup - HRV / ERV Ventilation

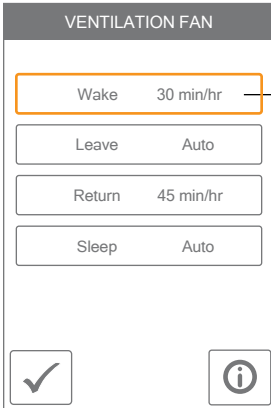

When a programmable schedule is used, there is a ventilation setting for each time period.

The ventilation fan runs for the set amount of time per hour.



# Error Messages

When an error occurs an email notification will be sent to the registered mobile account owner.

## Description

### **MEMORY ERROR**

The thermostat memory settings are corrupted. To clear, load the factory defaults in the Toolbox menu. The thermostat will not operate any heating or cooling equipment while this error message is present.

### **INTERNAL ROOM SENSOR FAULT**

Due to an open or short circuit, the thermostat is unable to read the internal room temperature sensor. If sensor 1, 2 or 3 is set to room the thermostat continues to operate, otherwise operation stops.

The error cannot be field repaired. Contact your tekmar sales representative for warranty or repair procedures.

### **INTERNAL HUMIDITY SENSOR FAULT**

Due to an open or short circuit, the thermostat is unable to read the internal humidity sensor. The thermostat stops controlling the humidifier or dehumidifier unless an external humidity sensor is installed on Sensor 3.

The error cannot be field repaired. Contact your tekmar sales representative for warranty or repair procedures.

### **SENSOR 1 FAULT**

Due to an open or short circuit, the thermostat is unable to read the sensor wired to S1 and Com. The thermostat stops normal operation if sensor 1 is the only active room or floor sensor or if a floor maximum temperature has been set.

Check the auxiliary sensor wire for short circuits according to the sensor installation manual. It may be necessary to replace the auxiliary sensor. Once the error has been corrected, the error message automatically clears.

### **SENSOR 2 FAULT**

Due to an open or short circuit, the thermostat is unable to read the sensor wired to S2 and Com. The thermostat stops normal operation if sensor 2 is the only active room or floor sensor or if a floor maximum temperature has been set.

Check the auxiliary sensor wire for short circuits according to the sensor installation manual. It may be necessary to replace the auxiliary sensor. Once the error has been corrected, the error message automatically clears.

### **SENSOR 3 FAULT**

Due to an open or short circuit, the thermostat is unable to read the sensor wired to S3 and Com. The thermostat stops normal operation if sensor 3 is the only active room sensor or if a floor maximum temperature has been set.

Check the auxiliary sensor wire for short circuits according to the sensor installation manual. It may be necessary to replace the auxiliary sensor. Once the error has been corrected, the error message automatically clears.

Description
<p><b>INTERNET UNAVAILABLE</b> The thermostat has a WiFi connection to the router but is unable to communicate to the Internet. Steps to clear the error include: 1) power off and on the router, 2) power off and on the thermostat.</p>
<p><b>ROOM HOT WARNING</b> The room temperature is above the Room Hot Warning setting in the Alerts menu. The warning will automatically clear once the room temperature falls below the setting.</p>
<p><b>ROOM COLD WARNING</b> The room temperature is below the Room Cold Warning setting in the Alerts menu. The warning will automatically clear once the room temperature rises above the setting.</p>
<p><b>LOW HUMIDITY WARNING</b> The relative humidity is below the Low Humidity Warning setting in the Alerts menu. The warning will automatically clear once the relative humidity rises above the setting.</p>
<p><b>HIGH HUMIDITY WARNING</b> The relative humidity is above the High Humidity Warning setting in the Alerts menu. The warning will automatically clear once the relative humidity falls below the setting.</p>
<p><b>AUXILIARY HEAT RUN TIME WARNING</b> The auxiliary heat has been operating continuously longer than the Aux Heat Run Time Warning setting in the Alerts menu. The error clears when the auxiliary heat turns off. There may be problem with your heat pump. Contact your heating professional for service.</p>
<p><b>CHANGE AIR FILTER WARNING</b> The fan run time has exceeded the Change Air Filter setting in the Alerts menu and requires replacement. To clear the warning, press the Air Filter Replaced button.</p>
<p><b>CHANGE UV LAMP WARNING</b> The UV lamp run time has exceeded the UV Lamp setting in the Alerts menu and requires replacement. To clear the warning, press the UV Lamp Replaced button.</p>
<p><b>ZIP/POSTAL CODE ERROR</b> The thermostat was unable to locate the ZIP or Postal Code entered in the WiFi menu. Please try again with a ZIP or Postal Code of a nearby area.</p>

# Technical Data

<b>WiFi Thermostat 563</b> <i>Conventional 2H/2C or Heat Pump 4H/2C</i>	
Literature	Submittal, Installation and Operating Manual, User Manual, Job Record, Watts Home Manual
Control	Microprocessor control. This is not a safety (limit) control.
Packaged weight	0.7 lb. (300 g)
Dimensions	4-5/8" H x 3" W x 15/16" D (118 x 76 x 24 mm)
Display	3.5" color touchscreen
Enclosure	White PVC plastic, NEMA Type 1
Approvals	Meets Class B: ICES & FCC Part 15
Ambient conditions	Indoor use only, 32 to 122°F (0 to 50°C), RH ≤90% non-condensing
Environmental	Do not use in presence of ammonia (animal barns).
Power supply	15 to 30 V (ac/dc), 2 VA, Class 2
Relays	30 V (ac/dc), 2 A, Class 2 circuits
Humidity sensor	0 to 90% ±4% RH
Temperature sensor	NTC thermistor, 10 kΩ @ 77°F (25°C ±0.2°C) β=3892
– Included	None
– Optional	tekmar type # 070, 072, 073, 076, 077, 079, 084, 086, 087
Communications	WiFi 802.11n, 2.4 GHz, WPA2 encryption
Mobile app	Apple iOS 12 or higher, Android 10 or higher
Languages	English/Français/Español

# Warranty

**Limited Warranty** *The liability of tekmar under this warranty is limited. The Purchaser, by taking receipt of any tekmar product ("Product"), acknowledges the terms of the Limited Warranty in effect at the time of such Product sale and acknowledges that it has read and understands same.*

The tekmar Limited Warranty to the Purchaser on the Products sold hereunder is a manufacturer's pass-through warranty which the Purchaser is authorized to pass through to its customers. Under the Limited Warranty, each tekmar Product is warranted against defects in workmanship and materials if the Product is installed and used in compliance with tekmar's instructions, ordinary wear and tear excepted. The pass-through warranty period is for a period of twenty-four (24) months from the production date if the Product is not installed during that period, or twelve (12) months from the documented date of installation if installed within twenty-four (24) months from the production date.

The liability of tekmar under the Limited Warranty shall be limited to, at tekmar's sole discretion: the cost of parts and labor provided by tekmar to repair defects in materials and / or workmanship of the defective product; or to the exchange of the defective product for a warranty replacement product; or to the granting of credit limited to the original cost of the defective product, and such repair, exchange or credit shall be the sole remedy available from tekmar, and, without limiting the foregoing in any way, tekmar is not responsible, in contract, tort or strict product liability, for any other losses, costs, expenses, inconveniences, or damages, whether direct, indirect, special, secondary, incidental or consequential, arising from ownership or use of the product, or from defects in workmanship or materials, including any liability for fundamental breach of contract.

The pass-through Limited Warranty applies only to those defective Products returned to tekmar during the warranty period. This Limited Warranty does not cover the cost of the parts or labor to remove or transport the defective Product, or to reinstall the repaired or replacement Product, all such costs and expenses being subject to Purchaser's agreement and warranty with its customers.

Any representations or warranties about the Products made by Purchaser to its customers which are different from or in excess of the tekmar Limited Warranty are the Purchaser's sole responsibility and obligation. Purchaser shall indemnify and hold tekmar harmless from and against any and all claims, liabilities and damages of any kind or nature which arise out of or are related to any such representations or warranties by Purchaser to its customers.

The pass-through Limited Warranty does not apply if the returned Product has been damaged by negligence by persons other than tekmar, accident, fire, Act of God, abuse or misuse; or has been damaged by modifications, alterations or attachments made subsequent to purchase which have not been authorized by tekmar; or if the Product was not installed in compliance with tekmar's instructions and / or the local codes and ordinances; or if due to defective installation of the Product; or if the Product was not used in compliance with tekmar's instructions.

THIS WARRANTY IS IN LIEU OF ALL OTHER WARRANTIES, EXPRESS OR IMPLIED, WHICH THE GOVERNING LAW ALLOWS PARTIES TO CONTRACTUALLY EXCLUDE, INCLUDING, WITHOUT LIMITATION, IMPLIED WARRANTIES OF MERCHANTABILITY AND FITNESS FOR A PARTICULAR PURPOSE, DURABILITY OR DESCRIPTION OF THE PRODUCT, ITS NON-INFRINGEMENT OF ANY RELEVANT PATENTS OR TRADEMARKS, AND ITS COMPLIANCE WITH OR NON-VIOLATION OF ANY APPLICABLE ENVIRONMENTAL, HEALTH OR SAFETY LEGISLATION; THE TERM OF ANY OTHER WARRANTY NOT HEREBY CONTRACTUALLY EXCLUDED IS LIMITED SUCH THAT IT SHALL NOT EXTEND BEYOND TWENTY-FOUR (24) MONTHS FROM THE PRODUCTION DATE, TO THE EXTENT THAT SUCH LIMITATION IS ALLOWED BY THE GOVERNING LAW.

**Product Warranty Return Procedure** All Products that are believed to have defects in workmanship or materials must be returned, together with a written description of the defect, to the tekmar Representative assigned to the territory in which such Product is located. If tekmar receives an inquiry from someone other than a tekmar Representative, including an inquiry from Purchaser (if not a tekmar Representative) or Purchaser's customers, regarding a potential warranty claim, tekmar's sole obligation shall be to provide the address and other contact information regarding the appropriate Representative.

**Need help? Go to our website or contact us.**

[tekmarControls.com](http://tekmarControls.com) | [tekmar.customerservice@wattswater.com](mailto:tekmar.customerservice@wattswater.com) | 1-800-438-3903

**tekmar**<sup>®</sup>

A WATTS Brand

Tel: 1-800-438-3903 • Fax: (250) 984-0815  
[tekmarControls.com](http://tekmarControls.com)