

Engineering Specification

Job Name _____

Contractor _____

Job Location _____

Approval _____

Engineer _____

Contractor's P.O. No. _____

Approval _____

Representative _____

LEAD FREE*

Series LFC500 Reduced Pressure Detector Assembly

2½" – 10"

Series LFC500 Reduced Pressure Detector assembly provides protection to the potable water system from contamination in accordance with national plumbing codes. The series is normally used in health-hazard applications to protect against back-siphonage, backpressure, and the fouling of either check valve. Series LFC500 is used to monitor unauthorized use of water from the fire protection system and features Lead Free* construction to comply with Lead Free* installation requirements.

The series include a flood sensor to detect excessive water discharges from the relief valve. The flood sensor relays a signal that triggers a multichannel alert (call, email, text) to notify personnel about potential flooding.

NOTICE

An add-on connection kit is required to activate the flood sensor. Without the connection kit, the flood sensor is a passive component and will not communicate with any other device. (A retrofit sensor connection kit is also available for existing installations. For more information, download RP/IS-A-C400/C500.)

Features

- Extremely compact design
- 70% lighter than traditional designs
- Type 304 (Schedule 40) stainless steel housing and sleeve
- Groove fittings for integral pipeline adjustment
- Patented link check for lowest pressure loss
- Unmatched ease of serviceability
- Replaceable check disc rubber
- Available with grooved butterfly valve shutoffs
- Bottom-mounted cast stainless steel relief valve
- Metered bypass to detect leakage or theft of water from the fire sprinkler system
- Sensor on the relief valve for flood detection
- Flood alert feature activated by add-on sensor connection kit

*The wetted surface of this product contacted by consumable water contains less than 0.25% of lead by weight.

Ames Fire & Waterworks product specifications in U.S. customary units and metric are approximate and are provided for reference only. For precise measurements, please contact Ames Fire & Waterworks Technical Service. Ames Fire & Waterworks reserves the right to change or modify product design, construction, specifications, or materials without prior notice and without incurring any obligation to make such changes and modifications on Ames Fire & Waterworks products previously or subsequently sold.

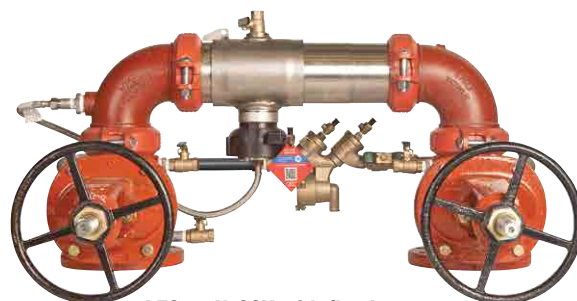

LFC500N-OSY with flood sensor

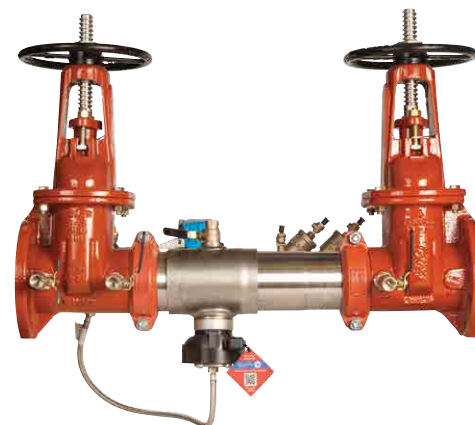

LFC500-OSY with flood sensor

NOTICE

The information contained herein is not intended to replace the full product installation and safety information available or the experience of a trained product installer. You are required to thoroughly read all installation instructions and product safety information before beginning the installation of this product.

Inquire with governing authorities for local installation requirements.

NOTICE

Use of the flood sensor does not replace the need to comply with all required instructions, codes, and regulations related to installation, operation, and maintenance of this product, including the need to provide proper drainage in the event of a discharge.

Watts® is not responsible for the failure of alerts due to connectivity or power issues.

Specification

The Colt LFC500 Reduced Pressure Detector assembly shall consist of two independent Link Check modules, a differential pressure relief valve located between and below the two modules, two drip tight shutoff valves, and required test cocks. Link Check modules and relief valve shall be contained within a sleeve accessible single housing constructed from Type 304 (Schedule 40) stainless steel pipe with groove end connections. Link Checks shall have reversible elastomer discs and in operation produce drip tight closure against the reverse flow of liquid caused by backpressure or backsiphonage. The bypass assembly consists of a meter registering either gallon or cubic measurements, a reduced pressure zone assembly, and required test cocks. Assembly shall be Colt LFC500 as manufactured by the Ames Fire & Waterworks, and shall include a sensor on the relief valve for flood detection.

Materials

Housing & Sleeve	Type 304 (Schedule 40) stainless steel
Elastomers	EPDM, silicone, and Buna-N
Link Checks	Noryl®, stainless steel
Check Discs	Reversible silicone or EPDM
Test Cocks	Lead Free* bronze body
Pins & Fasteners	300 Series stainless steel
Springs	Stainless steel

Configurations

- Horizontal
- "Z" pattern horizontal
- "N" pattern horizontal

Approvals

- Approved by the Foundation for Cross-Connection Control and Hydraulic Research at The University of Southern California (FCCCCHR-USC)
(OSY only excluding N and Z configurations sizes 6" – 10")
- AWWA C511-97



For additional approval information, contact the factory or visit our website at www.amesfirewater.com.

Model/Option

- FS – Sensor on the relief valve for flood detection
- OSY – UL Classified and FM Approved outside stem and yoke resilient seated gate valves
- BFG – UL Classified and FM Approved grooved gear operated butterfly valves w/tamper switch
- OSY FxG** – Flanged inlet gate connection and grooved outlet gate connection
- OSY GxF** – Grooved inlet gate connection and flanged outlet gate connection
- OSY GxG** – Grooved inlet gate connection and grooved outlet gate connection

Pressure – Temperature

Temperature Range: 33°F – 110°F (0.5°C – 43°C)
Maximum Working Pressure: 175 psi (12.1 bar)

Noryl is a registered trademark of SHPP Global Technologies B.V.

**Options for the gate valve:

- Consult factory for dimensions.
- Available with grooved NRS gate valves; consult factory.
- Post indicator plate and operating nut available; consult factory.

Dimensions — Weights

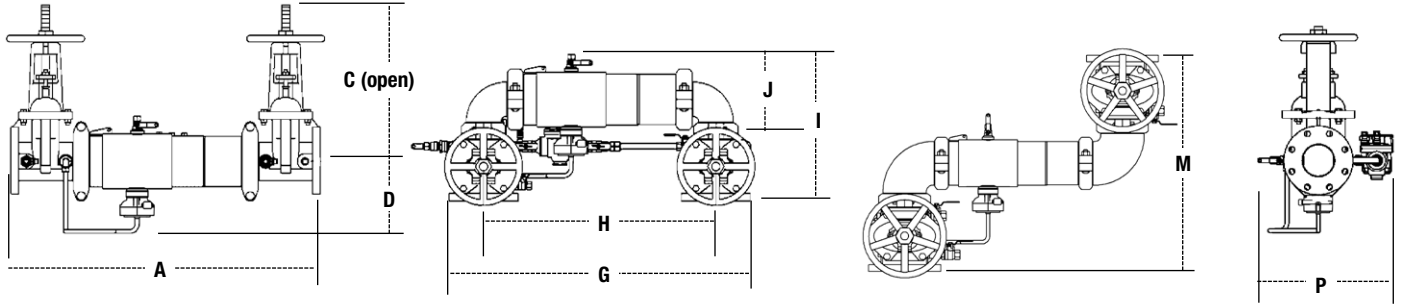

LFC500, LFC500N, LFC500Z

SIZE	DIMENSIONS														WEIGHT							
	A		C (OSY)		D		G		H		I		J		M		P		C500		C500N	
in.	in.	mm	in.	mm	in.	mm	in.	mm	in.	mm	in.	mm	in.	mm	in.	mm	in.	mm	lb	kg	lb	kg
2½	30¾	781	16⅝	416	6½	165	29¼	738	21½	546	15½	393	8⅜	223	21¼	540	13⅜	335	142	64	150	68
3	31¾	806	18⅝	479	6⅞	170	30¼	768	22¼	565	17⅝	435	9⅞	233	23	584	14½	368	162	73	175	79
4	33¾	857	22¼	578	7	178	33	838	23½	597	18½	470	9⅞	252	26¼	667	15⅞	386	178	81	201	91
6	43½	1105	30⅞	765	8½	216	44¼	1137	33¼	845	23⅞	589	13⅞	332	32¼	819	19	483	312	142	353	160
8	49¾	1264	37¼	959	9⅞	246	54⅞	1375	40⅞	1019	27⅞	697	15⅞	399	36⅞	937	21⅞	538	497	225	572	259
10	57¾	1467	45¾	1162	11⅞	285	66	1676	49½	1257	32½	826	17⅞	440	44½	1124	24	610	797	362	964	437

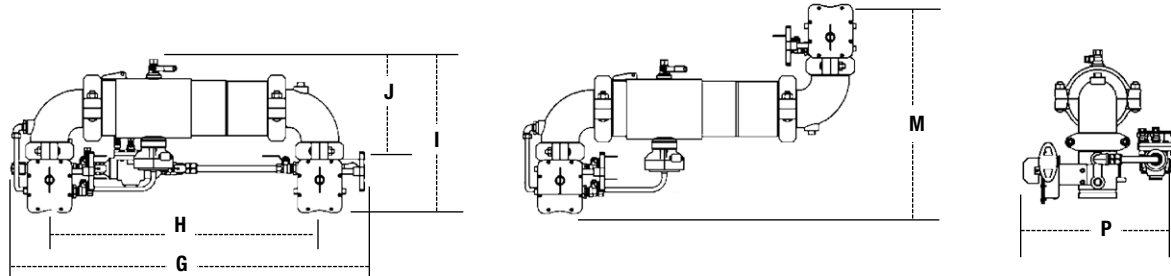

LFC500NBFG, LFC500ZBFG

SIZE	DIMENSIONS								WEIGHT					
	G		H		I		J		M		P		C500BFG	
in.	in.	mm	in.	mm	in.	mm	in.	mm	in.	mm	in.	mm	lb	kg
2½	32½	826	23	584	15½	394	9½	241	19¾	502	15⅞	402	81	37
3	34	864	24	610	16⅞	414	10⅞	256	21¼	540	16⅞	410	84	38
4	35⅞	905	25½	648	17⅞	437	10⅞	279	23½	597	16⅞	422	101	46
6	46½	1181	35¼	895	20½	521	13½	343	27¼	692	19	483	174	79

Capacity

UL Classified and FM Approved certified flow characteristics.
 N and Z flow characteristics collected using butterfly shutoff valves.

— Horizontal — N - Pattern - - - - Z - Pattern

Flow capacity chart identifies valve performance based upon rated water velocity up to 25 fps.

- Service Flow is typically determined by a rated velocity of 7.5 fps based upon Schedule 40 pipe.
- Rated Flow identifies maximum continuous duty performance determined by AWWA.
- UL Flow Rate is 150% of Rated Flow and is not recommended for continuous duty.
- AWWA Manual M22 (Appendix C) recommends that the maximum water velocity in services be not more than 10 fps.

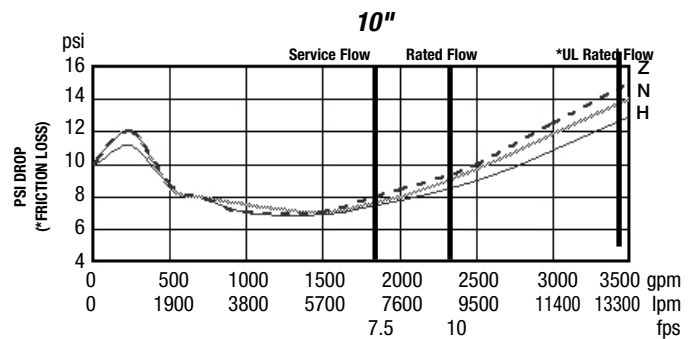
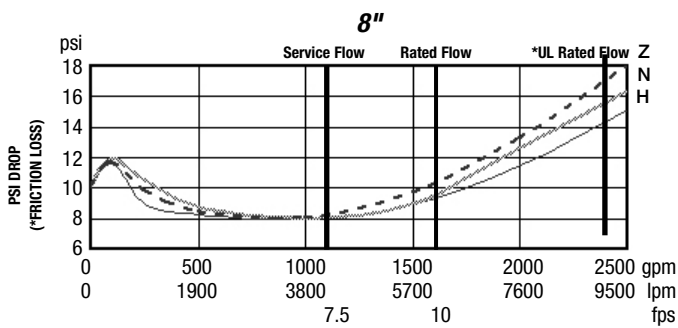
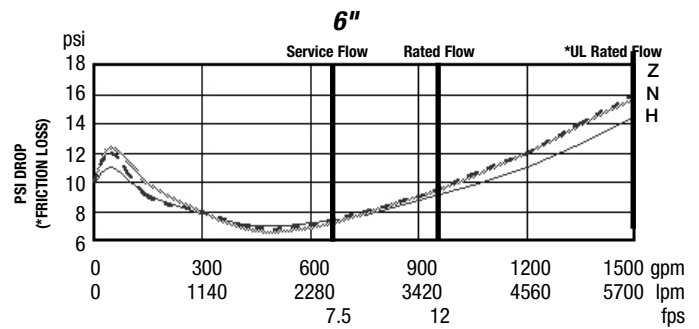
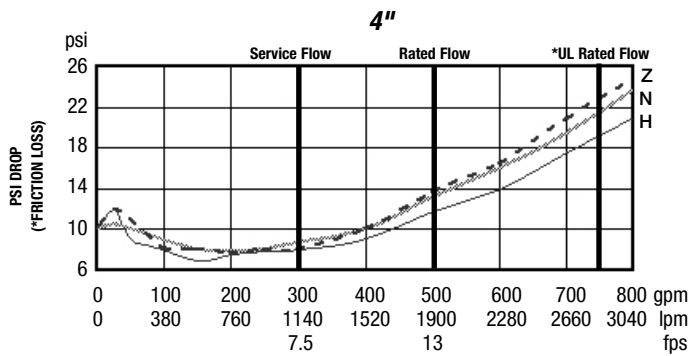
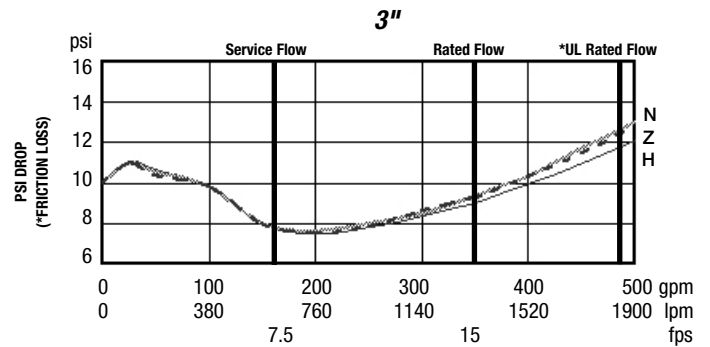
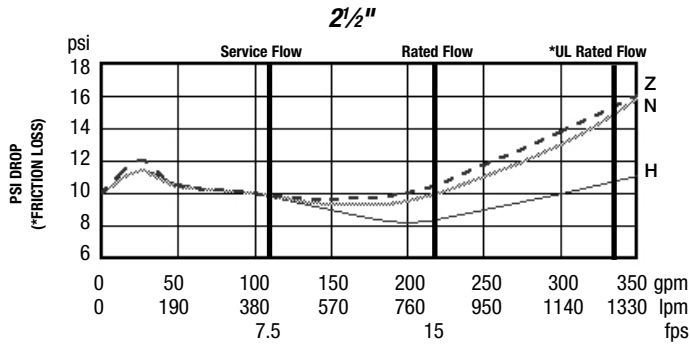

A WATTS Brand

USA: Backflow T: (978) 689-6066 • AmesFireWater.com
 USA: Control Valves T: (713) 943-0688 • AmesFireWater.com
 Canada: T: (888) 208-8927 • AmesFireWater.ca
 Latin America: T: (52) 55-4122-0138 • AmesFireWater.com