



**A WATTS Brand**



# **OWNER'S MANUAL**

## **MicroTPI & MicroTPW**

### **Field Portable Turbidimeters**

**HF scientific, inc.**  
**16260 Airport Park Drive**  
**Suite 140**  
**Ft. Myers, FL 33913**  
**Phone: 239-337-2116**  
**Fax: 239-454-0694**  
**Toll free: 888-203-7248**  
**Email: [HF.info@wattswater.com](mailto:HF.info@wattswater.com)**  
**Website: [www.hfscientific.com](http://www.hfscientific.com)**

Manual Cat No. 24378 (03/21)  
Rev. 3



# DECLARATION OF CONFORMITY

Application of Council Directive

Standard to which Conformity is Declared:

Product Safety - Tested and passed CE EN61010-1:1990 + A1:1992 (73/32 EEC)

Immunity and Emissions – Tested and passed EN61326-1: 2013

Manufacturer's Name: HF scientific, inc.  
Manufacturer's Address: 16260 Airport Park Drive, Suite 140, Fort Myers, Florida 33913  
Type of Equipment: Field Portable Turbidimeter  
Model No: MicroTPI & MicroTPW

I, the undersigned, hereby declare that the equipment specified above conforms to the above Directives and Standards.

Place: Fort Myers, Florida US

Date: 26 March, 2021

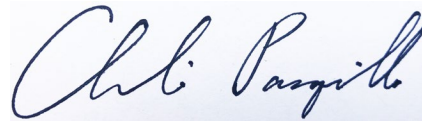

(Signature)  
Charlie Pasquariello  
Product Manager  
HF scientific

# Table of Contents

<b>Specifications</b> .....	1
<b>1.0 Overview</b> .....	3
1.1 Unpacking and Inspection of the Instrument and Accessories .....	3
1.2 The Display.....	4
1.3 The Instrument and Touch Pad .....	5
<b>2.0 Safety</b> .....	5
2.1 Icons Used in this Manual.....	4
<b>3.0 Normal Operation</b> .....	5
3.1 Routine Measurement .....	7
<b>4.0 Instrument Calibration</b> .....	8
4.1 Calibration Standards.....	8
4.2 Indexing the Calibration Standards.....	8
4.3 Calibration Procedures.....	8
4.4 Calibration Error .....	9
4.5 Restore Factory Calibration .....	9
<b>5.0 Routine Maintenance</b> .....	10
5.1 Cuvette Cleaning and Care .....	10
5.2 Battery Replacement.....	10
<b>6.0 Troubleshooting</b> .....	11
6.1 System Warning Messages .....	11
6.2 Battery Low Indicator .....	11
6.3 System Error Messages.....	12
6.4 Technical and Customer Assistance .....	12
<b>7.0 Accessories and Replacement Parts List</b> .....	13
<b>8.0 Warranty</b> .....	14
8.1 Waterproof Seal.....	14
<b>9.0 Glossary</b> .....	15

## Specifications

Measurement Range	0.01 –1100 NTU/FNU
Accuracy	±2% of reading or 0.01 NTU (0-500 NTU) ±3% of reading (500-1100 NTU)
Resolution	0.01 NTU below 100.0 NTU, 0.1 NTU for 100.0 NTU – 999.9 1.0 NTU for 1000 to 1100 NTU
Regulatory Compliance	MicroTPI IR (860 nm) LED Compliant to ISO 7027 MicroTPW Tungsten Lamp Compliant to U.S. EPA 180.1
Principle of Operation	Nephelometry
Response Time	Less than 14 Seconds
Display	4 digit 7 Segment Liquid Crystal Display with Special Icons
Operating Temperature Range	0°C – 50°C (32°F – 122°F)
Sample Temperature Range	0°C – 50°C (32°F – 122°F)
Sample Size	10-15 mL
Relative Humidity	0-90% Non Condensing
Power Supply	4 – AAA Batteries Battery life is approx.5000 readings with standard alkaline batteries
Certification	CE
Insulation Rating	Pollution Degree 2
Approximate Dimensions	Instrument: 7 cm x 16.5 cm x 4.8 cm (2 ¾” x 6 ½” x 1 7/8”) Instrument in Minilab Case: 25 cm x 21.6 cm x 6.3 cm (10” x 8 1/2” x 2 1/2”)
Enclosure	ABS
Shipping Weight	1.22 kg (2.70 lbs)
Shipping Dimensions	28 cm x 30.5 cm x 7.6 cm (11” x 12” x 3”)
Warranty	1 Year from date of shipment



## 1.0 Overview

The MicroTPI/TPW allows for the measurement of turbidity in the field. The MicroTPI was designed to meet the design criteria specified in ISO 7027 and DIN 27027 for the measurement of the turbidity of a sample. The MicroTPW was designed to meet the criteria specified in USEPA 180.1 on turbidity measurement.

### 1.1 Unpacking and Inspection of the Instrument and Accessories

The table below indicates items included in the turbidimeter shipment.

Item	Quantity
Field Portable Turbidimeter with 4 AAA batteries installed	1
Instruction Card	1
Instruction Manual	1
Instrument Carrying Case	1
<i>ProCal</i> Calibration Set (0.02, 10.0 , 1000 NTU Standards)	1
Empty Cuvettes	2
Lens Cloth	1

Remove the instrument from the packing carton. Carefully inspect all items to ensure that no visible damage has occurred during shipment. If the items received do not match the order, please immediately contact the local distributor or the HF scientific, inc. Customer Service department.

#### **CAUTION**

Extra care should be taken when unpacking, opening, and handling the calibration standards and sample cuvettes in the Accessory Kit; surface scratches or finger smudges on the cuvette surface may cause measurement errors. Handle these items by the cap of the cuvette only.

#### **NOTICE**

The instrument is shipped with the batteries installed.

Figure 1 is a depiction of the top of the instrument. The three main components of the instrument are the sample well, the display, and the touch pad. The following sections will describe the functionality of the display and the touch pad. The proper use of the instrument and the sample well will be discussed in later sections.



Figure 1: Top view of the instrument (MicroTPW shown).

## 1.2 The Display

All of the items that can appear on the display are shown in Figure 2. The display is used for reporting the turbidity levels and to provide user guidance in the calibration routine. In addition, the display also has other icons that are used to indicate when the instrument is in calibration mode & to indicate error conditions and battery warnings.

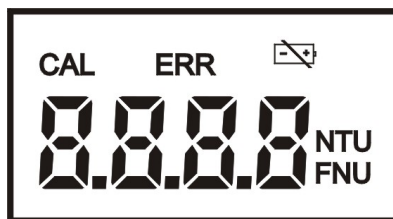

Figure 2 – Display used in the instrument.



### 1.3 The Touch Pad

The touch pad has five buttons: **ON/OFF**, **CAL**, **↵**, **▲**, and **▼**. The **ON/OFF** button is used to turn the instrument on and off. The **CAL** button is used to enter or exit calibration. The **↵** button, when pressed and held can be used to index the current sample, when the button is released it starts a reading or calibration. The **▲** and **▼** buttons are used to change the calibration points.

## 2.0 Safety

This manual contains basic instructions for the operation, care and maintenance of the instrument. The safety protection provided by this equipment may be impaired if it is used in a manner not described in this manual. It is recommended that all operators should read this manual prior to working with this instrument.

In certain instances **NOTES**, or helpful hints, have been highlighted to give further clarification to the instructions. Refer to the *Table of Contents* to easily find specific topics and to learn about unfamiliar terms.

### 2.1 Icons Used in this Manual



**This symbol identifies important information, practices or actions.**



**This symbol identifies hazards which, if not avoided, could result in minor or moderate injury or damage to the equipment.**

### 3.0 Normal Operation

This instrument allows for the measurement of the turbidity of a grab sample. The turbidity is reported in Nephelometric Turbidity Units (NTU) and Formazin Nephelometric Units (FNU). Readings above 1100 NTU are outside the range of this instrument.

**NOTICE**

**Nephelometric turbidity units (NTU's) are numerically equivalent to Formazin nephelometric units (FNU's) (See Glossary).**

Below are some typical screens and a description of when you should see them.

When turning on the instrument or after a calibration, this screen indicates that the instrument is ready to read:

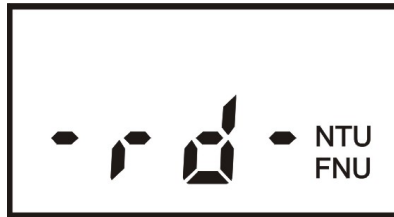

The instrument will display moving dashes on the screen for 6-7 seconds prior to displaying a value. This will occur prior to taking a reading & prior to indexing. No keypad presses will operate during this time.

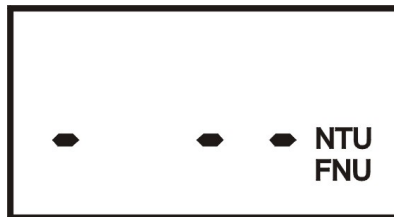

After taking a reading, a typical display:



If the sample that is being measured has a turbidity that is higher than that which the instrument can measure, the instrument will indicate this as an over-range condition by flashing 1100:

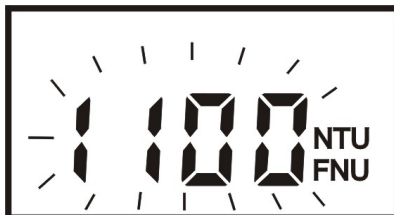

### 3.1 Routine Measurement

Turn on the instrument by pressing the ON/OFF button for 1 second.

The following are the recommended steps to take a reading:

1. Sample approximately 100 mL of the process.
2. Obtain a clean and dry sample cuvette.
3. Rinse the cuvette with approximately 10 mL of the sample water (2/3 of cuvette volume), capping the cuvette with the black light shield (cuvette top) and inverting several times. Discard the used sample and repeat the rinsing procedure two more times.
4. Completely fill the rinsed cuvette (from step 3) with the remaining portion (approximately 15 mL) of the grab sample and then cap the cuvette with the supplied cap. Ensure that the outside of the cuvette is dry, clean and free from smudges<sup>1</sup>
5. Place the cuvette into the instrument and press it down until it snaps fully into the sample well. Index the cuvette by pressing and holding down the ↵ button while rotating the cuvette to identify the lowest reading (the displayed turbidity is continuously updated on the display). Once the cuvette is indexed, release the ↵ button to display the measured turbidity (see Glossary for more information on indexing a cuvette).
6. Repeat steps 1 through 5 for all samples.

#### **CAUTION**

***NEVER* pour liquid directly into the sample well of the instrument always use a cuvette. The instrument will only accurately measure the turbidity of a sample when cuvettes sealed with the black cap are used. The black cap serves as both seal and a light shield.**

#### **NOTICE**

1. The instrument will turn off after approximately 5 minutes if no buttons are pressed.
2. To minimize drift, indexing is allowed for only a short period of time. After this period the calibration or reading of the sample is automatically initiated.
3. The value displayed during indexing is for the purpose indexing only. The final reading may vary from the indexing value.

---

<sup>1</sup> Any typical glass cleaner can be used along with a lint free cloth, or tissue (Kimwipes®), to clean the outside of the cuvette.

## 4.0 Instrument Calibration

The instrument was calibrated and tested prior to leaving the factory. Therefore, it is possible to use the instrument directly out of the box. However, re-calibration of the instrument is recommended to help with familiarization and the operation of the instrument and the calibration procedures. In addition, re-calibration is recommended at least once every three months.

The instrument requires three (3) standards to be fully calibrated.

During calibration, the instrument performs several system self-diagnostics. As such, several warning messages may be displayed. If the instrument detects an irregularity (detectors or lamp) a warning message will be displayed. If this occurs please attempt to rectify the problem, or contact the authorized technical services department (see section 6.4). In any event, the instrument will continue to read the turbidity with a decreased accuracy until the error is rectified.

### 4.1 Calibration Standards

We recommend the following materials during calibration to achieve the accuracy stated in this manual:

1. 1000 NTU *ProCal* Calibration Standard available from HF scientific inc.
2. 10.0 NTU *ProCal* Calibration Standard available from HF scientific inc.
3. 0.02 NTU *ProCal* Calibration Standard available from HF scientific inc.

It is well known that diluted Formazin is unstable. If Formazin is used to calibrate the instrument, ensure that a fresh stock suspension of Formazin is used to achieve the accuracy quoted for the instrument. A Formazin Stock Solution Kit is available. *ProCal* calibration standards are more stable than Formazin and have a limited shelf life of 2 years. If *ProCal* calibration standards are used to calibrate the instrument, review the expiration date to ensure that the standards have not expired. *ProCal* calibration standards are a US EPA approved alternative standard to Formazin.

### 4.2 Indexing the Calibration Standards

The United States Environmental Protection Agency (US EPA) recommends that cuvettes used for instrument calibration or sample measurement be indexed. To comply with this recommendation, each calibration standard is supplied with an indexing ring and each instrument has a reference point for quick and repeatable indexing of the calibration standard. To index a calibration standard perform the following steps:

1. While holding down the ↵ button, slowly rotate the calibration standard one complete revolution (360°) pausing between increments to allow the display to update.
2. While rotating the standard, observe the turbidity reading and locate the cuvette position with the lowest turbidity reading.
3. With the calibration standard positioned at the location having the lowest turbidity reading, install the Indexing Ring over the black light shield on the standard so that the pointer of the Ring aligns with the reference arrow on the instrument.

### 4.3 Calibration Procedures

The following procedure is recommended to perform a full range calibration. Ensure that the calibration standards have been indexed prior to proceeding.

1. Select the calibration function of the instrument by pressing the **CAL** button once. The “**CAL**” icon will be illuminated on the display with “**1000**” flashing indicating the standard required for this step of the calibration.

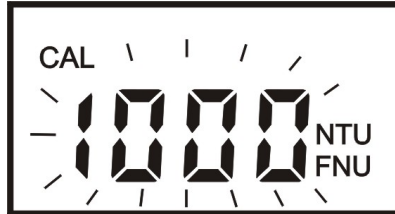

2. Insert the 1000 NTU standard into the sample well and press down until the cuvette snaps fully into the instrument. Align the indexing ring with the arrow on the instrument (see section 4.2 if the standard is not already indexed).
3. Press and hold the ↵ button while making fine adjustments to the indexing. Release the button to initiate the calibration. The display will now show a 30 second count down.
4. When the instrument has completed the calibration on the 1000 NTU, it will briefly display **1000** to indicate that it was calibrated and then prompts for the 10 NTU standard with a flashing “**10.0**”.

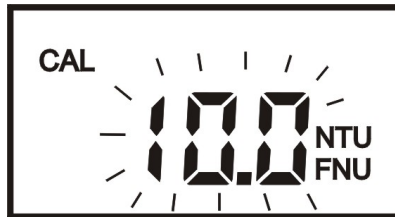

5. Insert the 10.0 NTU standard into the sample well and press down until the cuvette snaps fully into the instrument. Align the indexing ring with the arrow on the instrument (see section 4.2 if the standard is not already indexed).
6. Press and hold the ↵ button while making fine adjustments to the indexing. Release the button to initiate the calibration. The display will now show a 60 second count down.
7. When the instrument has completed calibration on the 10.0 NTU, it will briefly display **10.0** to indicate that it was calibrated and then prompts for the 0.02 NTU standard with a flashing “**0.02**”.

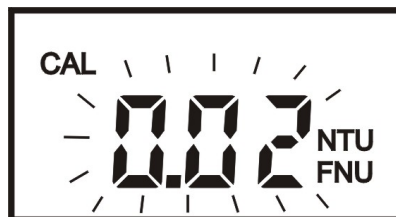

8. Insert the 0.02 NTU standard into the sample well and press down until the cuvette snaps fully into the instrument. Align the indexing ring with the arrow on the instrument (see section 4.2 if the standard is not already indexed).
9. Press and hold the ↵ button while making fine adjustments to the indexing. Release the button to initiate the calibration. The display will now show a 30 second count down
10. When the instrument has completed the calibration on the 0.02 NTU standard, the instrument returns to the read mode and is ready to read.

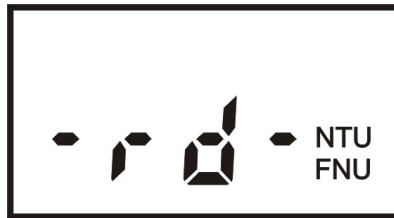

**NOTICE**

1. **Exiting the calibration mode may be done at the end of any step by pressing the CAL button. The instrument will store any of the values calibrated prior to exiting.**
2. **Any of the three calibration points (1000 NTU, 10 NTU & 0.02 NTU) can be selected for individual calibration by using the ▲ & ▼ buttons.**
3. **The required calibration values are set in software and can not be changed.**

#### 4.4 Calibration Error

If the screen shown below is displayed after calibration, the internal diagnostics have determined that the calibration standards were bad or that they were inserted in the wrong order. Either check the standards and recalibrate or restore the factory calibration as mentioned below.

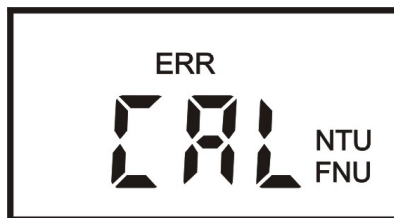

#### 4.5 Restore Factory Calibration

If the above display appears and it can not be corrected by recalibration, the operator can restore the factory calibration. Please note that the instrument may operate with reduced accuracy until a new calibration can be performed.

Push and hold the ▲ button. Now push and release the ↵ button then release the ▲ button. The instrument will turn itself off when completed. When the instrument is turned on again the error screen will be gone.

## 5.0 Routine Maintenance

If the instrument is not kept in the supplied carrying case, when not in use, ensure that the instrument has been turned off and that a clean sample cuvette fitted with a black cap has been placed in the sample well. This will ensure that a minimal amount of dust and/or debris will be able to settle on the optics of the instrument

### 5.1 Cuvette Cleaning and Care

Proper measurement of the turbidity of a sample requires the use of a cuvette that is free of marks, smudges, scratches and any bacterial growth. Cleaning the cuvette is accomplished by washing the interior and exterior of the cuvette in a detergent solution. Once cleaned, the cuvette should be rinsed thoroughly 8 to 10 times with clean distilled water to eliminate the possibility of detergent buildup and streaking. Cleaned and dried cuvettes should be stored with the black caps on. During normal operation any typical glass cleaner along with a lint free cloth or tissue (Kimwipes®), may be used to clean the outside of the cuvettes.

Condensation may appear on the cuvette when a sample is very cold and the relative humidity is high. When this happens, the turbidity displayed may be higher than the actual turbidity due to the light scattered by the condensate on the cuvette. To alleviate the problem, either coat the cuvette with an anti-fogging agent, or by running warm water over the cuvette for a short period of time to warm the sample prior to measurement.

### 5.2 Battery Replacement

The instrument will periodically require new batteries to function properly. This will be indicated with a battery icon on the display. To replace the batteries:

1. Turn the instrument off and place it upside down on a soft surface.
2. Remove the two screws (A) securing the battery cover (B). Lift cover off.
3. Remove the old batteries. Place four new AAA batteries (C) into the battery compartment (ensuring the correct polarity).
4. Replace the battery cover and fasten the two screws carefully to ensure a watertight seal.
5. Dispose of used batteries in accordance with all federal, state and local regulations.

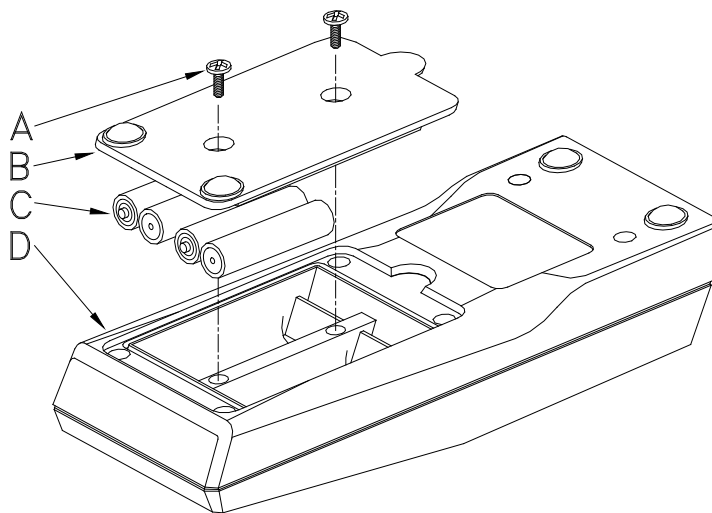

Figure 3: Detailed view of the battery compartment

## 6.0 Troubleshooting

The instrument routinely performs self-diagnostics, and will automatically generate messages to provide specific diagnostic information.

### 6.1 System Warning Messages

Automatic warning messages are generated to provide specific diagnostic information about the instrument. These messages are for the operator's use and do not indicate a reduction in the performance of the instrument or a failure of any component in the instrument.

### 6.2 Battery Low Indicator

There are two battery warning levels. A flashing battery icon on the display indicates that the batteries need to be replaced, but the readings displayed are still accurate. This is a warning that the batteries are low.

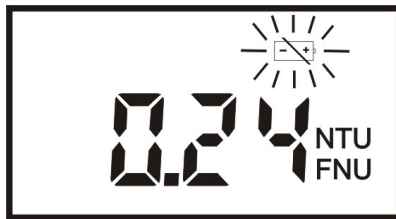

A solid battery icon on the display indicates that power level is too low and the readings may be out of specification. Under this condition, the batteries should be replaced as soon as possible to ensure that the instrument will continue to function properly. If the batteries get too low to perform, the instrument will turn off & the instrument may not turn on until the batteries have been replaced. See section 6.2 for more information

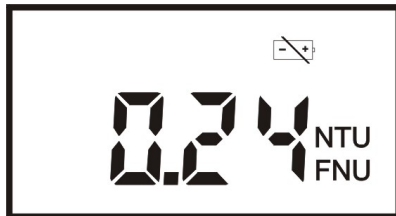



### 6.3 System Error Messages

Normally, the cause of an error message is external to the instrument. If an error is identified the instrument will turn on the error icon (ERR) .

The following table lists the error messages and their associated meanings:

<b>ERROR</b>	<b>SOLUTION</b>
<b>Err</b> Icon on	Internal Error contact HF scientific Technical Service Dept.
<b>Err</b> Icon on Display reads <b>CAL</b>	Bad standards or standards in wrong order see section 4.4 for more information

### 6.4 Technical and Customer Assistance

If assistance is needed regarding this instrument please contact the HF scientific, inc. Technical Service Department.

HF scientific, inc.  
16260 Airport Park Drive, Suite 140  
Fort Myers, Florida 33913  
Phone: (239) 337-2116  
Fax: (239) 454-0694  
Toll free: 888-203-7248  
Email: [HF.info@wattswater.com](mailto:HF.info@wattswater.com)  
Website: [www.hfscientific.com](http://www.hfscientific.com)

## 7.0 Accessories and Replacement Parts List

The items shown below are recommended accessories and replacement parts for the instrument.

Accessory	Catalog Number
<i>ProCal</i> Calibration Set for normal operation (includes 0.02 NTU, 10.0 NTU and 1000 NTU Standards).	39845
Turbidity Free Water, 4 Liters (1gal.)	70908
Formazin Stock Solution, 4000 NTU, 500 mL	70914
Operators Manual	24378
Formazin Stock Solution Kit	50040
Sample Cuvettes – 3 pack	19856
Rechargeable Battery Kit	19859

To order any accessory or replacement part, please contact the HF scientific, inc. Customer Service Department. See section 6.4 for contact information.

## 8.0 Warranty

HF scientific, LLC (the “Company”) warrants each municipal market instrument product to be free from defects in material and workmanship under normal usage for a period of one (1) year from first use or two (2) years from date of the Company’s invoice from the original sale of the product, whichever occurs first. In the event of such defects within the warranty period, the Company will, at its option, replace or recondition the product without charge. Parts which by their nature are normally required to be replaced periodically, consistent with normal maintenance, specifically reagents, desiccant, sensors, electrodes and fuses, are excluded. Also excluded are accessories and supply-type items.

Proof of purchase from the Company (Company invoice or paid order confirmation) and/or first use (commissioning) must be provided when making a product warranty claim.

**THE WARRANTY SET FORTH HEREIN IS GIVEN EXPRESSLY AND IS THE ONLY WARRANTY GIVEN BY THE COMPANY WITH RESPECT TO THE PRODUCT. THE COMPANY MAKES NO OTHER WARRANTIES, EXPRESSED OR IMPLIED. THE COMPANY HEREBY SPECIFICALLY DISCLAIMS ALL OTHER WARRANTIES, EXPRESSED OR IMPLIED, INCLUDING BUT NOT LIMITED TO, THE IMPLIED WARRANTIES OR MERCHANTABILITY AND FITNESS FOR A PARTICULAR PURPOSE.**

The remedy described in the first paragraph of this warranty shall constitute the sole and exclusive remedy for breach of warranty, and the Company shall not be responsible for any incidental, special or consequential damages, including without limitation, lost profits or the cost of repairing or replacing other property which is damaged if this product does not work properly, other costs resulting from labor charges, delays, vandalism, negligence, fouling caused by foreign material, damage from adverse water conditions, chemical, or any other circumstances over which the Company has no control. In addition, the Company shall not be responsible for any costs incidental to the Company’s warranty response efforts, including, without limitation, costs associated with the removal and replacement of systems, structures or other parts of facilities, de-installation, decontamination and re-installation of products, or transportation of products to and from the Company. This warranty shall be invalidated by any abuse, misuse, misapplication, improper installation or improper maintenance of the product, alteration of the product or use of any parts or accessories (including but not limited to reagents) not provided by the Company.

Some states do not allow limitations on how long an implied warranty lasts, and some states do not allow the exclusion or limitation of incidental or consequential damages. Therefore the above limitations may not apply to you. This Limited Warranty gives you specific legal rights, and you may have other rights that vary from State to State. You should consult applicable state laws to determine your rights. **SO FAR AS IS CONSISTENT WITH APPLICABLE STATE LAW, ANY IMPLIED WARRANTIES THAT MAY NOT BE DISCLAIMED, INCLUDING THE IMPLIED WARRANTIES OF MERCHANTABILITY AND FITNESS FOR A PARTICULAR PURPOSE, ARE LIMITED IN DURATION TO ONE YEAR FROM THE DATE OF ORIGINAL SHIPMENT.**

### 8.1 Waterproof Seal

Opening the main instrument enclosure (excluding the battery compartment) may void the warranty.

## 9.0 Glossary

***Formazin Nephelometric Units (FNU)***: Equivalent in value to Nephelometric Turbidity Units (NTU)

***Formazin Turbidity Units (FTU)***: Equivalent in value to Nephelometric Turbidity Units (NTU)

***Indexing a Cuvette***: The United States Environmental Protection Agency (US EPA) recommends that cuvettes, used for turbidimeter calibration or sample measurement, be indexed. To index a cuvette with a sample in it, slowly rotate the cuvette throughout one complete revolution (360°). While rotating the sample cuvette, observe the display and locate the position that the cuvette is in, which provides the lowest turbidity reading. This position is the indexed position of the cuvette.

***Nephelometric Turbidity Units (NTU)***: Unit of measure used when relating the light scattered by a liquid media to the light scattered by a known concentration of Formazin Polymer. This unit of measure is recognized as a measure of the optical clarity of an aqueous sample. NTU is the accepted unit of measurement for turbidity.

***Turbidity***: 1) A measure of the attenuation of a radiant flux as it passes through a liquid media.  
2) Optical clarity of a liquid.  
3) A phenomena caused by the presence of undissolved matter in a liquid media.