

Installation, Operation and Maintenance Manual

Smart Boiler Control 294



⚠ WARNING



Please read carefully before proceeding with installation. Your failure to follow any attached instructions or operating parameters may lead to the product's failure.

Keep this Manual for future reference.

**THINK
SAFETY
FIRST**

tekmar[®]
A **WATTS** Brand

Table of Contents

Important Safety Information	3	Sequence of Operation	33
Radio Frequency Statement	4	Heating Calls.	33
Installation	5	Central Heating Operation.	33
Installation Location	5	Domestic Hot Water (DHW) Operation	35
Wiring Schematic	6	System Setup and Operation	36
Wiring Instructions	7	Constant Setpoint Operation.	38
Testing the Sensor Wiring	9	Remote Setpoint Call	39
User Interface	15	tekmarNet®4 Call	39
Power On	15	Boiler Operation	40
Lock Screen	15	Boiler Modbus Communication.	42
Home Screen	16	System Operation.	43
Status Icons	16	Pump Operation	46
System Inputs Screen.	17	Combustion Air Damper Operation	46
System Outputs Screen	17	Schedule.	47
Boiler Supply Chart Screen	17	Time Clock	47
Boiler Status List Screen.	18	Troubleshooting.	48
Boiler Status Carousel Screen.	18	Errors and Alerts	48-50
Boiler Hours or Cycles Screen.	18	Technical Data	52
Menu Screen	19	Limited Warranty and Product Return Procedure.	52
Navigation.	19		
Menus	20		
Home Screen	20		
Settings Menu.	21-28		
Schedule Menu.	29		
Notifications Menu	30		
Overrides Menu	30		
About Menu	32		
Help Menu	32		

Important Safety Information

⚠ WARNING

It is your responsibility to ensure that this control is safely installed according to all applicable codes and standards. tekmar® is not responsible for damages resulting from improper installation and/or maintenance.

To avoid serious personal injury and damage to the equipment:



- Read Manual and all product labels BEFORE using the equipment. Do not use unless you know the safe and proper operation of this equipment.



- Keep this Manual available for easy access by all users.
- Replacement Manuals are available at tekmarControls.com



This is a safety-alert symbol. The safety alert symbol is shown alone or used with a signal word (DANGER, WARNING, or CAUTION), a pictorial and/or a safety message to identify hazards.

When you see this symbol alone or with a signal word on your equipment or in this Manual, be alert to the potential for death or serious personal injury.



This pictorial alerts you to electricity, electrocution, and shock hazards.



Double insulated.

⚠ WARNING

This symbol identifies hazards which, if not avoided, could result in death or serious injury.

⚠ CAUTION

This symbol identifies hazards which, if not avoided, could result in minor or moderate injury.

NOTICE

This symbol identifies practices, actions, or failure to act which could result in property damage or damage to the equipment.

⚠ WARNING

- It is the installer's responsibility to ensure that this control is safely installed according to all applicable codes and standards.
- Improper installation and operation of this control could result in damage to the equipment and possibly even personal injury or death.
- This control is not intended for use as a primary limit control. Other controls that are intended and certified as safety limits must be placed into the control circuit.

NOTICE

Do not attempt to service the control. There are no user serviceable parts inside the control. Attempting to do so voids warranty.

Radio Frequency Statement

This equipment has been tested and found to comply with the limits for a Class A digital device, pursuant to part 15 of the FCC Rules. These limits are designed to provide reasonable protection against harmful interference when the equipment is operated in a commercial environment. This equipment generates, uses, and can radiate radio frequency energy and, if not installed and used in accordance with the instruction manual, may cause harmful interference to radio communications. Operation of this equipment in a residential area is likely to cause harmful interference in which case the user will be required to correct the interference at his own expense.

This device complies with part 15 of the FCC Rules and with Industry Canada license-exempt RSS standard(s). Operation is subject to the following two conditions: (1) this device may not cause harmful interference, and (2) this device must accept any interference received, including interference that may cause undesired operation.

The antenna used for this radio must be properly installed and maintained and must provide a separation distance of at least 7.9 inches (20 cm) from all persons.

Changes or modifications not expressly approved by the party responsible for compliance could void the user's authority to operate the equipment.

Le présent appareil est conforme aux CNR d'Industrie Canada applicables aux appareils radio exempts de licence. L'exploitation est autorisée aux deux conditions suivantes:

(1) l'appareil ne doit pas produire de brouillage, et

(2) l'utilisateur de l'appareil doit accepter tout brouillage radioélectrique subi, même si le brouillage est susceptible d'en compromettre le fonctionnement.

Installation

Installation Location

When choosing the location for the control, consider the following:

- Keep dry. Avoid potential leakage onto the control.
RH ≤ 90% to 104°F (40°C).
Non-condensing environment.
- Do not expose to operating temperatures beyond 32-104°F (0-40°C)
- Provide adequate ventilation.
- Keep away from equipment, appliances or other sources of electrical interference.
- Provide easy access for wiring, viewing, and adjusting the display screen.
- Mount approximately 5 ft. (1.5 m) off the finished floor.
- Locate the control near pumps and/or zone valves if possible.
- Provide a solid backing to mount the enclosure to. For example: plywood, studs, etc
- Use the conduit knockouts provided on the upper, lower, back and sides of the enclosure.

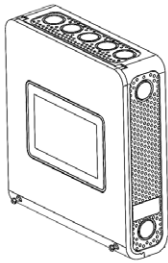

Use a Phillips screwdriver to remove the two screws on the cover.

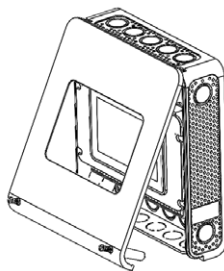

Pull the front cover towards you. The top of the cover will pivot on a hinge. Remove the cover by releasing the pivot hooks.

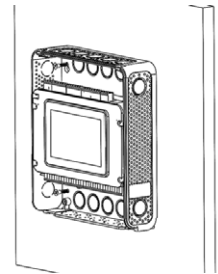

Mount the enclosure to a wall using #6 wood screws in the four mounting holes. Use screw anchors if drilling into masonry.

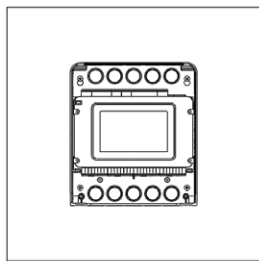

Use the 24 knock-outs to install connecting conduits and cabling to the control.

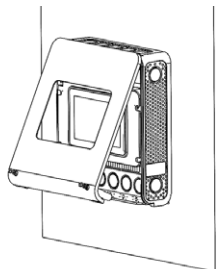

To install the cover, hook the top of the cover to the enclosure, then pivot the bottom to shut.

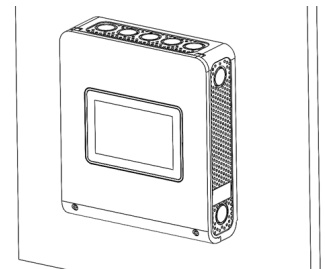

Use a Phillips screwdriver to fasten the two bottom screws.

Wiring Schematic

This section provides a wiring schematic for the control.

⚠ WARNING

- Before wiring, ensure all power is turned off and take all necessary precautions.
- Sensor wiring may be extended to a total length of 500 feet (152 m) using 18 AWG solid conductor wire.
- Strip all wiring to a length of 3/8 in. or 10 mm for all terminals.
- A circuit breaker or power disconnect that provides power to the control should be located nearby and clearly labeled.
- Refer to the current and voltage ratings at the back of this brochure before connecting devices to this control.
- Only qualified personnel should install or service the control.

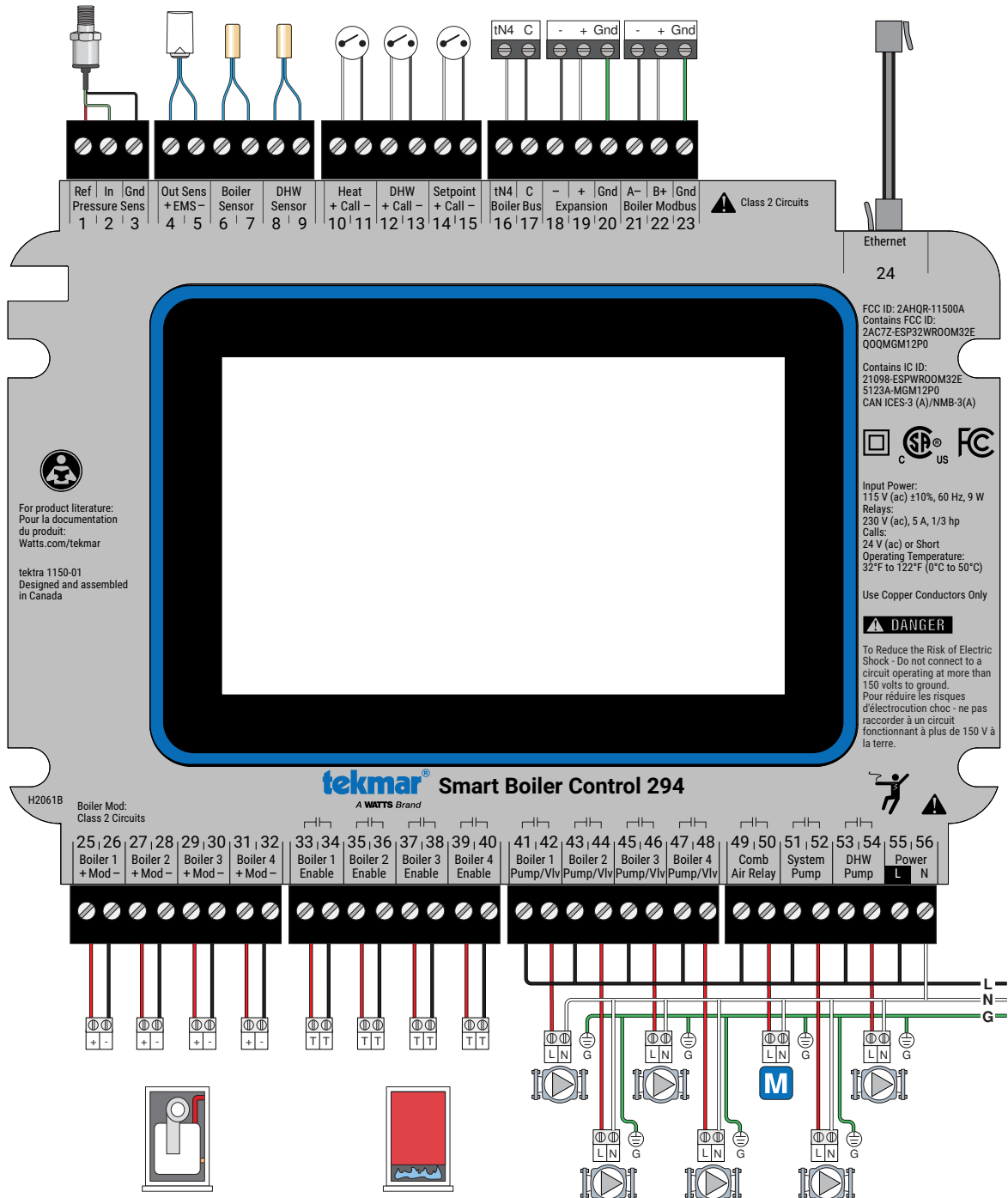

Wiring Instructions

This section explains how to wire individual devices to the Smart Boiler Control 294.

Pressure Sensor 088 (Terminals 1, 2, 3)

An optional Pressure Sensor 088 (sold separately) can connect to the 294 to provide pressure monitoring for hydronic systems up to 150 psi (1034 kPa). The pressure sensor requires the installation of a tee with a 1/8"-27 NPT port to be installed near the expansion tank.

- Connect the Red reference voltage wire to terminal 1.
- Connect the Green pressure signal wire to terminal 2.
- Connect the Black power common wire to terminal 3.

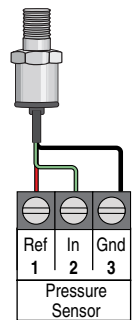

Outdoor Sensor 070 (Terminals 4, 5)

- The 070 can be mounted directly onto a wall with the wiring entering through the back or bottom of the enclosure. Do not mount the 070 with the conduit knockout facing upwards as rain could enter the enclosure and damage the sensor.
- In order to prevent heat transmitted through the wall from affecting the sensor reading, it may be necessary to install an insulating barrier behind the enclosure.
- The 070 should be mounted on a wall which best represents the heat load on the building (a northern wall for most buildings and a southern facing wall for buildings with large south facing glass areas). The 070 should not be exposed to heat sources such as ventilation or window openings.
- The 070 should be installed at an elevation above the ground that will prevent accidental damage or tampering.

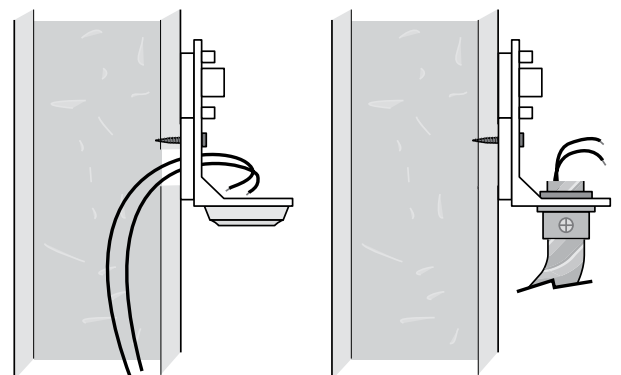
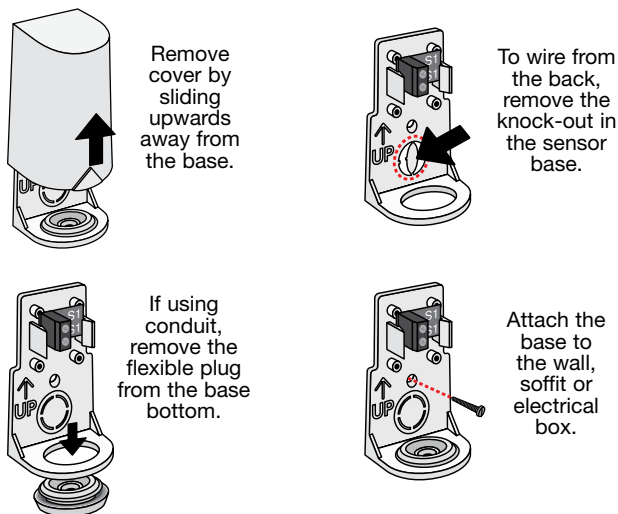

- Connect 18 AWG or similar wire to the two terminals provided in the enclosure and run the wires from the sensor to the control. Do not run the wires parallel to telephone or power cables. If the sensor wires are located in an area with strong sources of electromagnetic interference (EMI), shielded cable or twisted pair should be used or the wires can be run in a grounded metal conduit. If using shielded cable, the shield wire should be connected to the Com terminal on the control and not to earth ground.
- Replace the cover of the sensor enclosure.
- Connect the 2 wires from the outdoor sensor to the Out Sens terminals on the 294 (terminals 4 and 5).

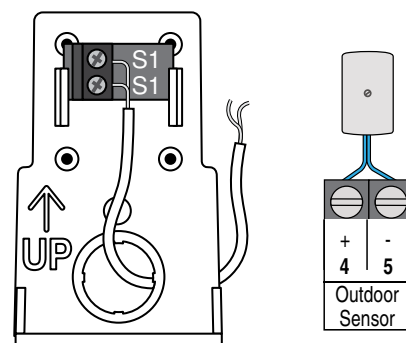

EMS Connection (Terminals 4, 5)

An Energy Management System (EMS) can be connected to the 294 to provide a target water temperature. This signal replaces the outdoor air temperature sensor. Either a 0 to 10 V (dc) or 2 to 10 V (dc) signal may be used.

- Connect one wire from the EMS to the Outdoor (+) terminal 4.
- Connect a second wire from the EMS to the Outdoor (-) terminal 5.

A 0 - 20 mA signal can be converted to a 0 - 10 V (dc) signal by installing a 500 Ω resistor in parallel between the Outdoor (+) and (-) terminals (4 and 5). The EMS Signal setting must be set to 0-10.

A 4 - 20 mA signal can be converted to a 2 - 10 V (dc) signal by installing a 500 Ω resistor in parallel between the Com (-) and EMS (+) In terminals (19 and 16). The EMS Signal setting must be set to 2-10.

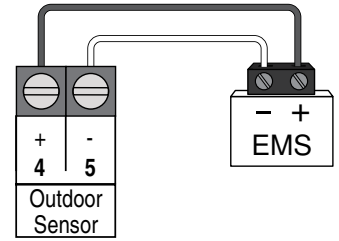

Mounting the Universal Sensors

These sensors are designed to mount on a pipe or in a temperature immersion well.

The Universal Sensor should be placed downstream of a pump or after an elbow or similar fitting. This is especially important if large diameter pipes are used as the thermal stratification within the pipe can result in erroneous sensor readings. Proper sensor location requires that the fluid is thoroughly mixed within the pipe before it reaches the sensor.

Strapped to Pipe

The Universal Sensor can be strapped directly to the pipe using the cable tie provided. Insulation should be placed around the sensor to reduce the effect of air currents on the sensor measurement.

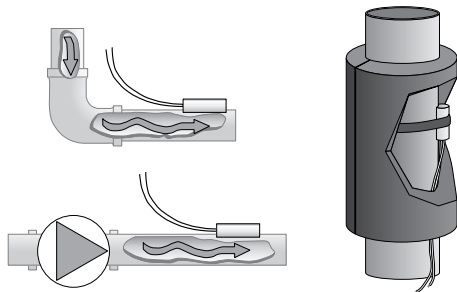

Immersion Well

If a Universal Sensor is mounted onto 1" diameter L type copper pipe, there is approximately an 8 second delay between a sudden change in water temperature and the time the sensor measures the temperature change. This delay increases considerably when mild steel (black iron) pipe is used. In general, it is recommended that a temperature well be used for steel pipe of diameter greater than 1¼". Temperature wells are also recommended when large diameter pipes are used and fluid

stratification is present. If the well is not a snug fit on the sensor tube, use the heat transfer paste. Apply paste to the sides of the sensor and place a pea-sized globule on the sensor tip. Push the sensor into the well and when it bottoms out, press firmly. The paste will be forced up the sides of the well.

Conduit Connection

The Universal Sensor and Universal Sensor Enclosure 080 (sold separately) are specifically designed to mount onto a 3/8" ID temperature well that is supplied with an end groove. To install the well, plumb a 'tee' into the pipe and fix the well into the 'tee'. The 080 enclosure has a 7/8" back knockout that must be removed and fitted over the temperature well. The Universal Sensor is then inserted into the well and the retaining clip supplied with the enclosure is snapped onto the well end groove. If the well has a threaded end, the installer must supply a standard threaded conduit retaining ring. The two wires from the sensor are connected to the terminal block provided in the enclosure. The other side of the terminal block is used to connect wires from the control.

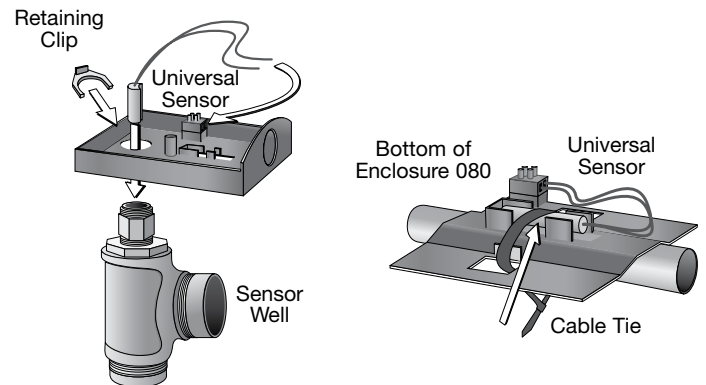

Boiler Sensor (Terminals 6, 7)

The included Universal Sensor 082 can measure the boiler supply temperature of water coming from the boiler system. This sensor should be installed on the supply pipe ahead of the tees supplying any loads.

- Connect the wires to the boiler sensor terminals 6 and 7.

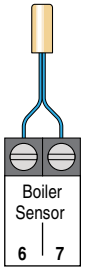

DHW Sensor (Terminals 8, 9)

A DHW sensor is used to measure the temperature of a DHW tank. For indirect DHW heating, the DHW sensor can be used instead of a DHW aquastat. For direct DHW heating, only the DHW sensor can be used to control the temperature of the DHW tank. The DHW Sensor 078 is sold separately.

- Connect the wires to the boiler sensor terminals 8 and 9.

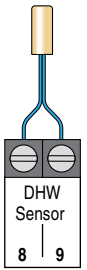

Testing the Sensor Wiring

A good quality test meter capable of measuring up to 5,000 k Ω (1 k Ω = 1000 Ω) is required to measure the sensor resistance. In addition to this, the actual temperature must be measured with either a good quality digital thermometer, or if a thermometer is not available, a second sensor can be placed alongside the one to be tested and the readings compared.

First measure the temperature using the thermometer and then measure the resistance of the sensor at the control. The wires from the sensor must not be connected to the control while the test is performed. Using the chart below, estimate the

temperature measured by the sensor. The sensor and thermometer readings should be close. If the test meter reads a very high resistance, there may be a broken wire, a poor wiring connection or a defective sensor. If the resistance is very low, the wiring may be shorted, there may be moisture in the sensor or the sensor may be defective. To test for a defective sensor, measure the resistance directly at the sensor location.

Do not apply voltage to a sensor at any time as damage to the sensor may result.

TEMPERATURE		RESISTANCE	TEMPERATURE		RESISTANCE	TEMPERATURE		RESISTANCE	TEMPERATURE		RESISTANCE
°F	°C	Ω	°F	°C	Ω	°F	°C	Ω	°F	°C	Ω
-50	-46	490,813	20	-7	46,218	90	32	7,334	160	71	1,689
-45	-43	405,710	25	-4	39,913	95	35	6,532	165	74	1,538
-40	-40	336,606	30	-1	34,558	100	38	5,828	170	77	1,403
-35	-37	280,279	35	2	29,996	105	41	5,210	175	79	1,281
-30	-34	234,196	40	4	26,099	110	43	4,665	180	82	1,172
-25	-32	196,358	45	7	22,763	115	46	4,184	185	85	1,073
-20	-29	165,180	50	10	19,900	120	49	3,760	190	88	983
-15	-26	139,403	55	13	17,436	125	52	3,383	195	91	903
-10	-23	118,018	60	16	15,311	130	54	3,050	200	93	829
-5	-21	100,221	65	18	13,474	135	57	2,754	205	96	763
0	-18	85,362	70	21	11,883	140	60	2,490	210	99	703
5	-15	72,918	75	24	10,501	145	63	2,255	215	102	648
10	-12	62,465	80	27	9,299	150	66	2,045	220	104	598
15	-9	53,658	85	29	8,250	155	68	1,857	225	107	553

Central Heat Call (Terminals 10, 11)

A central heat call is required whenever the building requires heating. The heat call can be volt free or up to 24 V (ac).

- Connect the Central Heat Call terminals 10 and 11 to a switched heat demand.
- Typical heat calls are from a switching relay, zone valve control or thermostat.
- A permanent heat call can be created by installing a jumper wire between terminals 10 and 11.

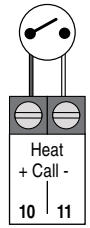

DHW Call (Terminals 12, 13)

If the DHW sensor option is not used, a call for indirect domestic hot water can come from an aquastat connected to terminals 12 and 13. The DHW Call can be volt free or up to 24 V (ac).

- Connect the DHW Call terminals 12 and 13 to the DHW tank aquastat.



Setpoint Call (Terminals 14, 15)

The setpoint call operates the boiler system to maintain a fixed setpoint temperature. The setpoint call should respond to loads that do not change with outdoor conditions. The setpoint call can be volt free or up to 24 V (ac).

- Connect the setpoint call terminals 14 and 15 to the output terminals on a setpoint control or thermostat.



tekmarNet4 Boiler Bus (Terminals 16, 17)

tekmarNet4 (tN4) is a wired communication network for tekmar thermostats, setpoint controls and snow melting controls to communicate to the boiler control. The network provides central heating calls, DHW calls and setpoint calls as a digital message between tekmar devices. This optimizes the heating system to operate more efficiently compared to on/off calls.

- The tN4 devices connect to the Boiler bus on terminals 16 and 17. The connection is polarity sensitive.
- Connect terminal 16 (tN4) to the tN4 terminal on the device.
- Connect terminal 17 (C) to the C terminal on the device.

Boiler Expansion (Terminals 18, 19, 20)

The control operates 4 on board boilers and is expandable in groups of 4 up to a maximum of 16 through the use of boiler expansions. The control connects to the expansion through a wired three-wire connection. The maximum bus cable length is 100 feet (30 m) using 18 AWG solid conductor cable.

- Connect terminal 21 (-) to the boiler expansion terminal 1 (-).
- Connect terminal 22 (+) to the boiler expansion terminal 2 (+).
- Connect terminal 23 (Gnd) to the boiler expansion terminal 3 (Gnd).

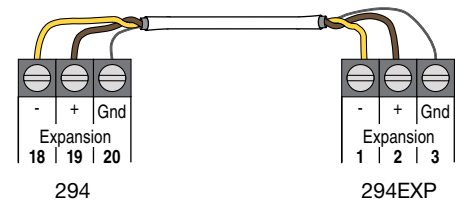

Boiler Modbus® Communication (Terminals 21, 22, 23)

The control can connect to select boilers that have an available Modbus communication port to read the boiler's error and lockout codes. The supported boilers are listed in the Sequence of Operation section of this manual.

Use an 18 AWG Shielded Twisted Pair (STP) cable to connect the control to each compatible boiler. The 294 operates as the bus master, and the boilers are member devices. All boilers must use the same data rate, data type, parity bit, start bit parameters as boiler 1. Boilers 1 to 16 are sequentially addressed 1 through 16.

- Connect the A (-) terminal on the boiler to the Modbus A (-) terminal 21.
- Connect the B (+) terminal on the boiler to the Modbus B (+) terminal 22.
- Connect the ground terminal on the boiler to the Gnd terminal 23.

Daisy chain wiring is recommended when connecting to multiple boilers.

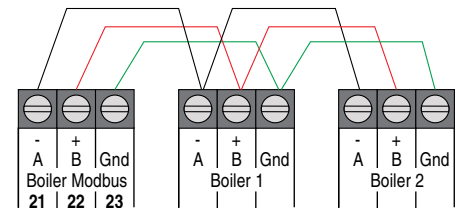

Ethernet (Terminal 24)

The control can connect to the Internet through Ethernet.

- Connect the Ethernet RJ-45 port on terminal 24 to the building Local Area Network (LAN) router or network switch using Category 5 cable.

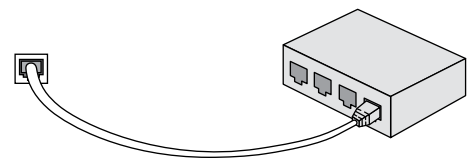

Modulating Boilers (Terminals 25 to 32)

The control provides either a 0-10 V (dc) or a 4-20 mA output to each boiler. Polarity is important.

- Connect the control Mod (+) terminals 25, 27, 29, 31 to boilers 1, 2, 3 and 4 analog signal input (+) respectively.
- Connect the control Mod (-) terminals 26, 28, 30, 32 to boilers 1, 2, 3 and 4 analog signal input (-) respectively.

Some modulating boilers may also require a boiler on/off enable signal in addition to the modulating signal. Please consult the boiler manual.

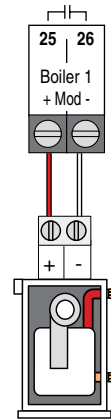

The 4 to 20 mA output can be converted to a 0 - 135 Ω output for a Modutrol IV™ gas valve actuating motor using a 0 - 135 Ω tekmar Converter 005 (sold separately).

The 4 to 20 mA output can be converted to a 0 - 135 Ω output for a V9055™ gas valve actuating motor using a 0 - 135 Ω tekmar Converter 005 (sold separately).

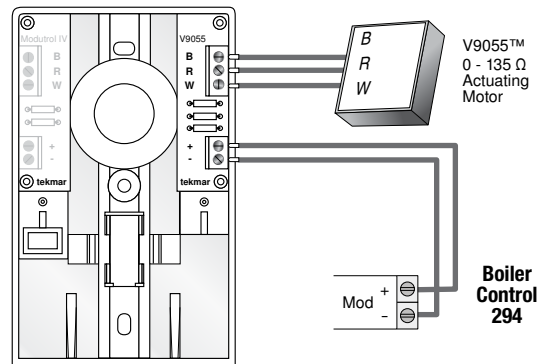
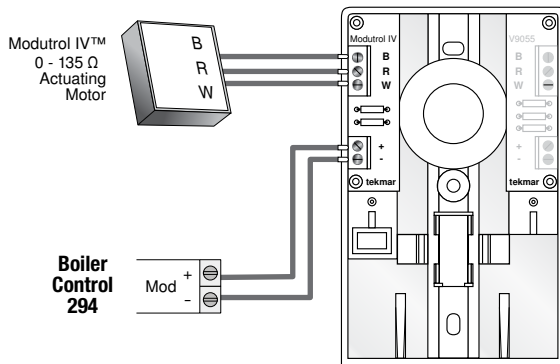

Modutrol IV™ and V9055™ are trademarks and products of Honeywell International, Inc.

Boiler Enable (Terminals 33 to 40)

A single stage condensing or non-condensing boiler is enabled through the TT contacts.

- For Boiler 1 connect the Boiler Enable terminals 33 and 34 to the boiler TT contacts.
- For Boiler 2 connect the Boiler Enable terminals 35 and 36 to the boiler TT contacts.
- For Boiler 3 connect the Boiler Enable terminals 37 and 38 to the boiler TT contacts.
- For Boiler 4 connect the Boiler Enable terminals 39 and 40 to the boiler TT contacts.

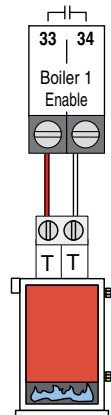

Boiler Pump / Valve (Terminals 41 to 48)

Boiler pumps or valves requiring up to 230 V (ac) 5 A, 1/3 hp can be switched through terminals 41 to 46. If a single power source is used for multiple pumps, ensure they are not tied together at any point between the pumps and the control. For simplicity in wiring and troubleshooting, a separate breaker for each pump is recommended.

For pumps:

- Connect the power source line wire (L) to terminal 41.
- Connect a wire from terminal 42 to the pump Line In terminal.
- Connect the pump Neutral (N) to the power source neutral.
- Repeat for additional boiler pumps 2 (terminals 43, 44), boiler pump 3 (45, 46) and boiler pump 4 (terminals 47, 48).
- Ensure each pump is connected to earth ground.

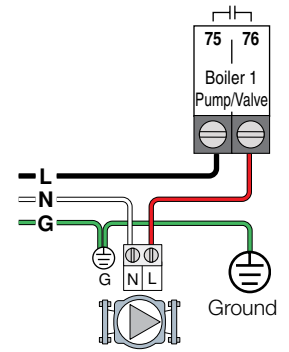

For 120 V (ac) valves:

- Connect the power source line wire (L) to terminal 41.
- Connect a wire from terminal 42 to the valve Line In terminal.
- Connect the valve Neutral (N) to the power source neutral.
- Repeat for additional boiler valves 2 (terminals 43, 44), valve 3 (45, 46) and valve 4 (terminals 47, 48).
- Ensure each pump is connected to earth ground.

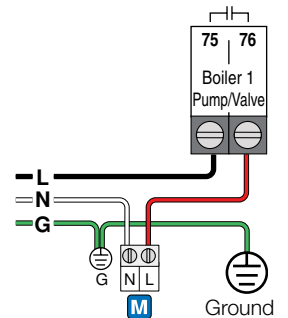

For 24 V (ac) valves:

- Connect the power source Red wire (R) to terminal 41.
- Connect a wire from terminal 42 to the valve power terminal.
- Connect the valve power common to the power source common (C).
- Repeat for additional boiler valves 2 (terminals 43, 44), boiler valve 3 (45, 46) and boiler valve 4 (terminals 47, 48).

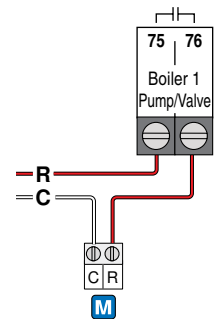

Combustion Air (C.A.) Damper (Terminals 49, 50)

A C.A. damper requiring up to 230 V (ac) 5 A, 1/3 hp can be switched through terminals 49 and 50.

For 24 V(ac) actuators:

- Connect the power supply red (R) to terminal 49.
- Connect a wire from terminal 50 to the R on the combustion air damper.
- Connect the C on the combustion air damper to the power source common C.
- For 120 V(ac) actuators:
- Connect the power Line (L) to terminal 49.
- Connect a wire from terminal 50 to the Line on the combustion air damper.
- Connect the neutral (N) on the combustion air damper to the power source common C.

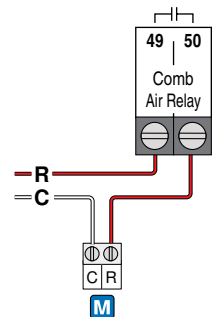

System Pump (Terminals 51, 52)

A system pump requiring up to 230 V (ac) 5 A, 1/8 hp can be switched through terminals 51 and 52. For simplicity in wiring and troubleshooting, a separate breaker for each pump is recommended.

- Connect the power source line wire (L) to terminal 51.
- Connect a wire from terminal 52 to the pump Line terminal.
- Connect a wire from the pump Neutral (N) back to the power source neutral.
- Ensure the system pump is connected to earth ground.

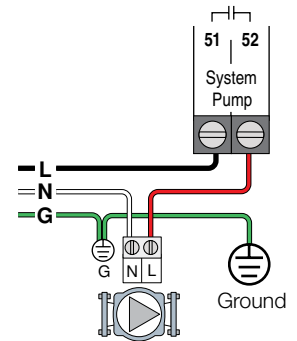

DHW Pump (Terminals 53, 54)

An indirect DHW pump requiring up to 230 V (ac) 5 A, 1/3 hp can be switched through the DHW Pump terminals.

- Connect the line wire (L) to terminal 53.
- Connect a wire from terminal 54 to the pump L.
- Connect a wire from the pump N back to the power source neutral.
- Ensure the DHW pump is connected to earth ground.

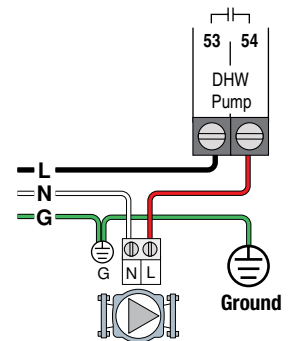

Input Power (Terminals 55, 56)

Provide a 15 Amp circuit for the input power.

- Connect the 115 V (ac) line wire (L) to terminal 55.
- Connect the neutral wire (N) to terminal 56.

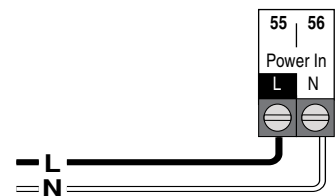

User Interface

Power On

- When first powered on, the tekmar logo appears.
- If the display does not turn on, please contact your tekmar sales representative or technical support for assistance.



Lock Screen

- When first powered on, the tekmar logo appears followed by the lock screen.
- By default the control is not locked and does not require a passcode.
- Press “Tap to Unlock”, and enter your passcode if necessary.

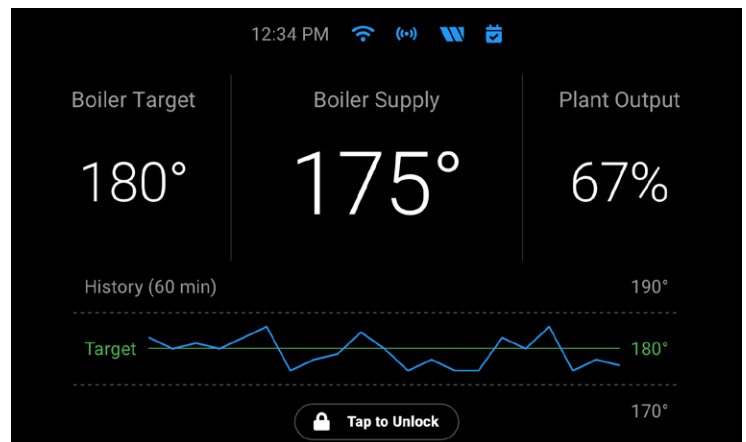



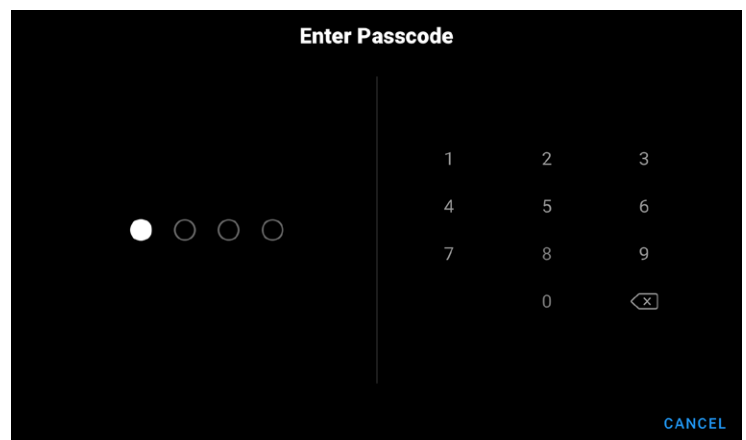

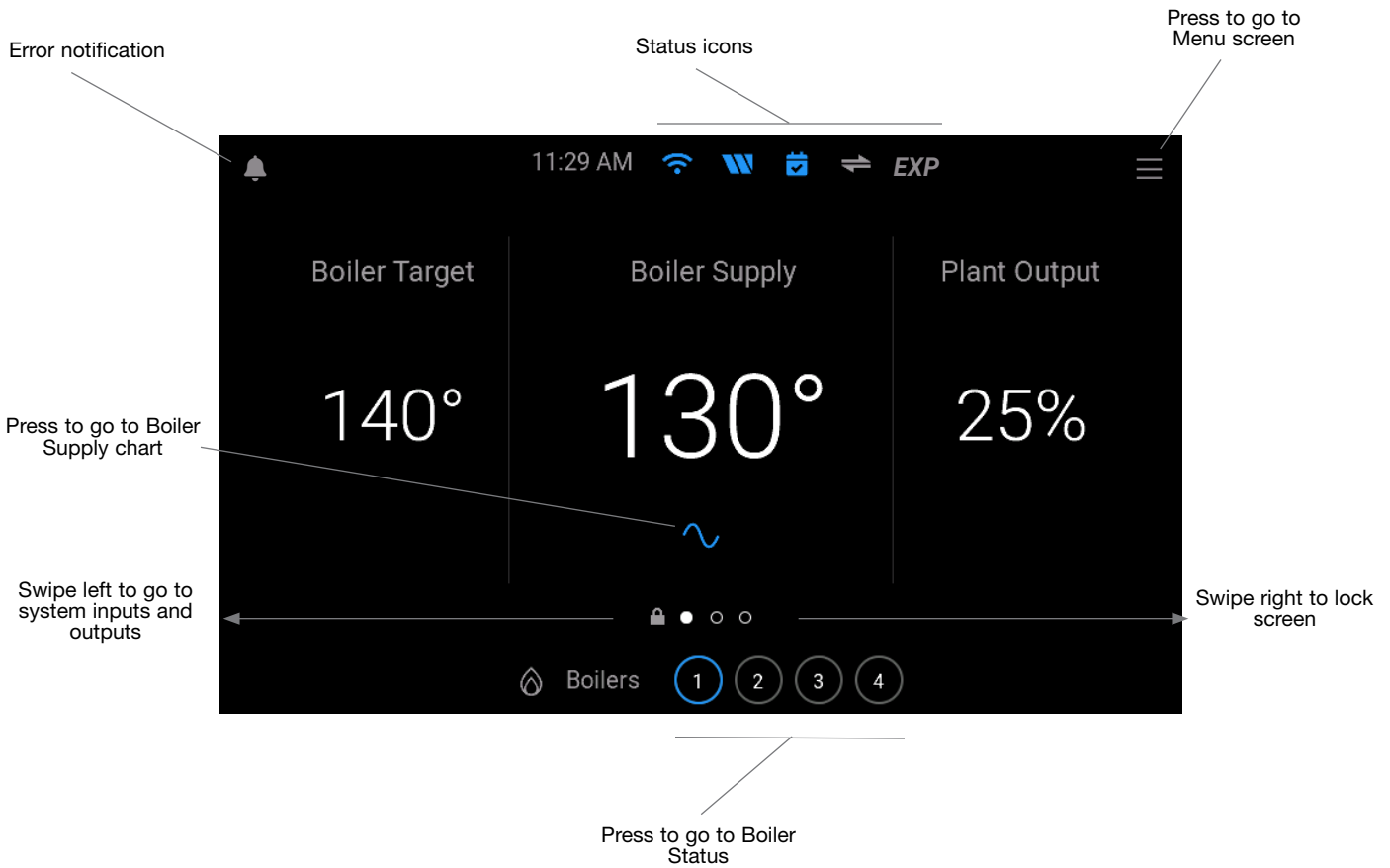

- A custom passcode can be set through the Security menu. This is an optional feature.
- If the custom passcode is lost, the master passcode is 0294.



Home Screen



Status Icons

	ETHERNET Blue indicates connection to Ethernet.		tekmarNet® Blue indicates communication with other tekmarNet® devices.
	WI-FI Blue indicates connection to Wi-Fi.		EXPANSION Blue indicates connection to a expansion control for boilers 5 to 16.
	WATTS ONSITE Blue indicates connection to the Watts® OnSite cloud service.		NOTIFICATIONS When displayed, it indicates an error or warning notification is present.
	SCHEDULE Blue indicates the programmable schedule is on.		

System Inputs Screen

- When a call for heat is active, the dot is green.
- When there is no call for heat, the dot is gray.
- The central heating and setpoint targets are for the boiler system.
- The Domestic Hot Water target may be for either the DHW tank or the boiler system. This is determined by the configuration settings DHW Type and DHW Sensor.
- The outdoor temperature can be measured by a wired sensor, through a sensor connected to a tekmarNet device or through an Internet weather service.
- The domestic hot water tank sensor is optional and is configured through the Settings > Heating Calls > Domestic Hot Water > DHW Sensor setting.
- The pressure sensor is optional and is configured through the Settings > System > Pressure Sensor setting.

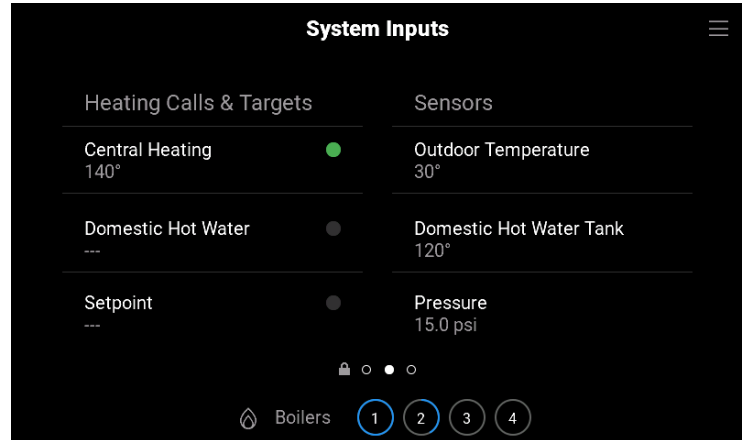

System Outputs Screen

- When an output is turned on (relay closed), the dot is green.
- When an output is turned off (relay open), the dot is gray.
- When Domestic Hot Water Priority is in effect, the dot is green.
- When Warm Weather Shut Down (WWSD) is in effect, the dot is green.
- Manual override are displayed. In normal operation the override will display "AUTO".

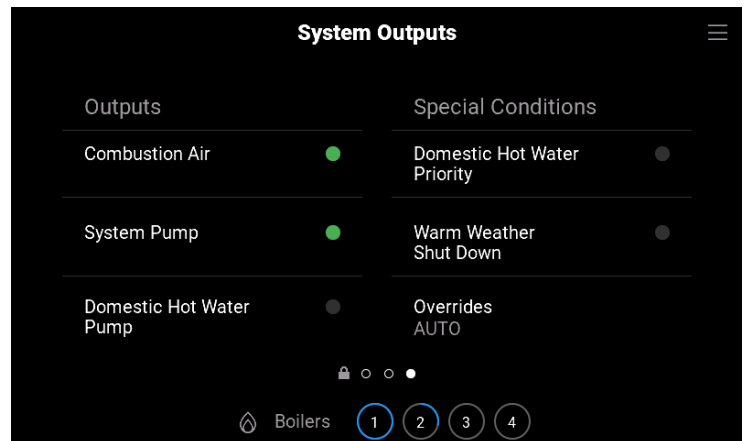

Boiler Supply Chart Screen

- The boiler supply chart updates once per second with the newest temperature data on the right.
- The chart time span x-axis is approximately 10 minutes.
- The temperature range y-axis automatically scales based upon the min and max boiler supply temperatures from the last 10 minutes.
- The boiler target is visible when between the min and max boiler supply temperatures from the last 10 minutes.



Boiler Status List Screen

- Press  to go to the Boiler Status Carousel screen
- The circle in blue indicates the boiler firing rate percent or boiler target temperature
- Press the boiler hour number to go to the Boiler Hours screen
- Press the boiler cycle number to go to the Boiler Cycles screen
- When the boiler pump is running or the boiler isolation valve is open, the dot is green
- When the boiler pump is off or the boiler isolation valve is closed, the dot is gray

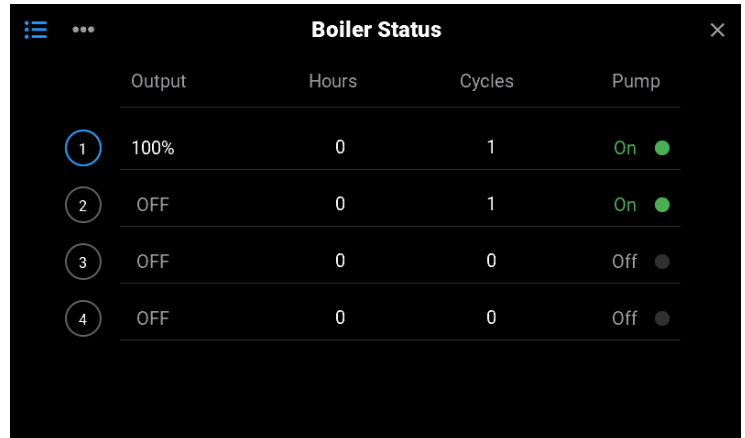

	Output	Hours	Cycles	Pump
1	100%	0	1	On ●
2	OFF	0	1	On ●
3	OFF	0	0	Off ●
4	OFF	0	0	Off ●

Boiler Status Carousel Screen

- Press  to go to the Boiler Status List Screen
- Swipe left to view higher number boilers
- Swipe right to view lower number boilers
- The circle in blue indicates the boiler firing rate percent or boiler target temperature
- Press the boiler hour number to go to the Boiler Hours screen
- Press the boiler cycle number to go to the Boiler Cycles screen
- When the boiler pump is running or the boiler isolation valve is open, the dot is green
- When the boiler pump is off or the boiler isolation valve is closed, the dot is gray

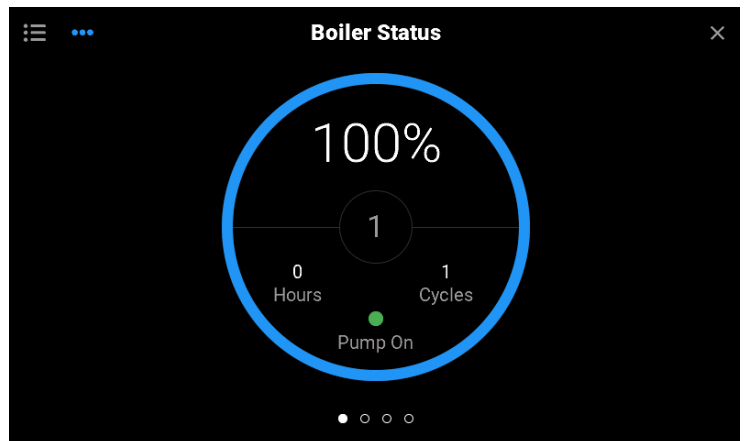

Boiler Hours or Cycles Screen

- Press CLEAR to zero the boiler hours or the boiler cycle count
- Pressing CLEAR also saves the zero hours or cycles
- Zeroing the hours places the boiler to the end of the boiler equal run time rotation sequence

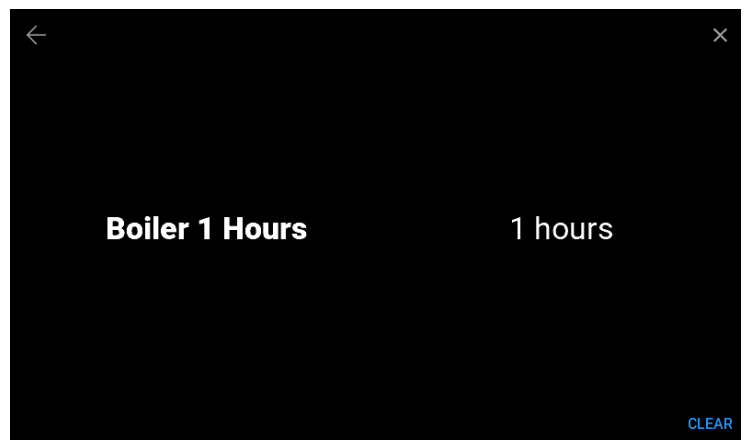

Menu Screen

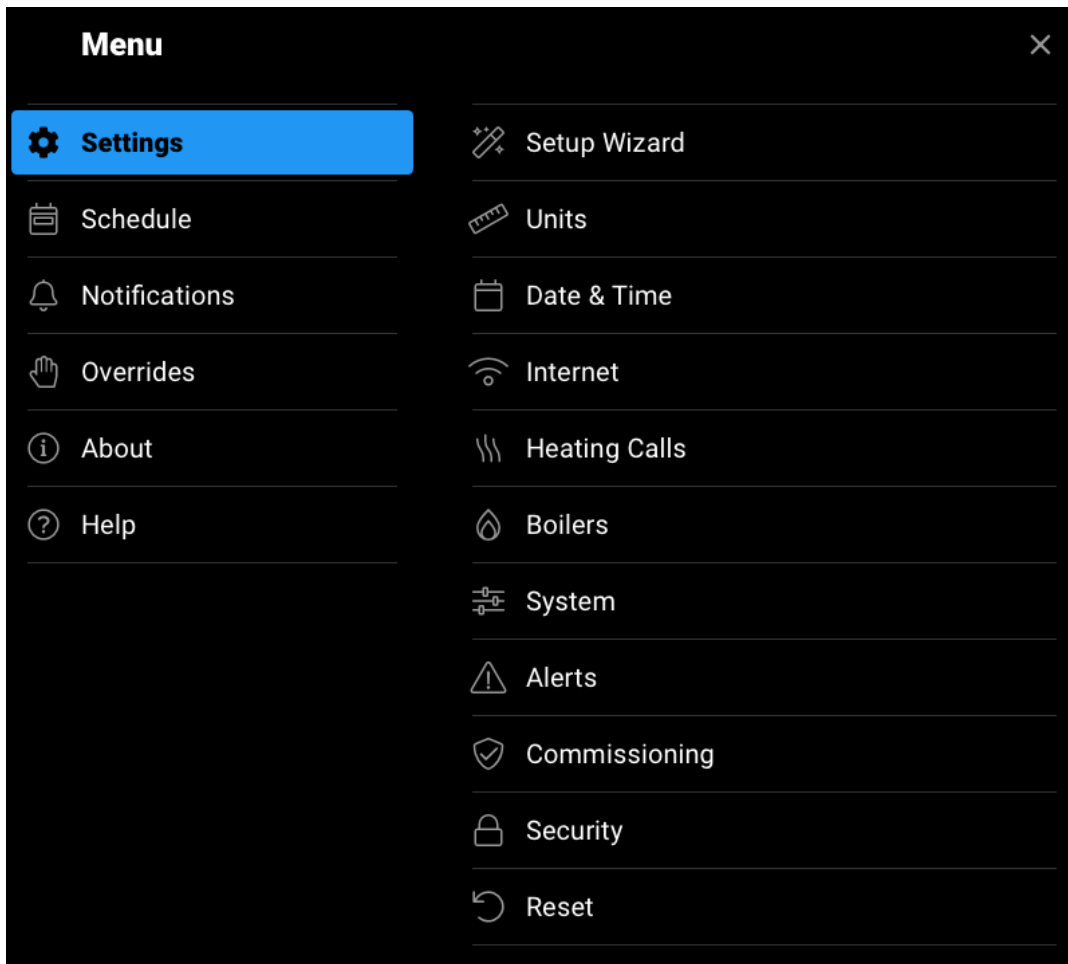

Navigation

	BACK Go back a level without saving	SKIP	SKIP Skip step in Setup Wizard or Wi-Fi Setup
	HOME Go to Home screen without saving	BEGIN	BEGIN Begin the Setup Wizard
SAVE	SAVE Saves the new setting value	NEXT	NEXT Go to the next step
CLEAR	CLEAR Clears the boiler hours or cycles to 0		

Home Screen

Parameter	Range	Description
BOILER SUPPLY	---, -22 to 266°F (-30 to 130°C)	Current boiler supply water temperature as measured by the boiler supply sensor. "---" is displayed if there is a sensor fault.
BOILER TARGET	---, -22 to 266°F (-30 to 130°C)	The boiler target is the temperature the control is trying to maintain at the boiler supply sensor. "---" is displayed when no heat is required.
PLANT OUTPUT	0 to 100%	The plant output is the combined firing rate of all the boilers together.
SYSTEM INPUTS		
CENTRAL HEATING TARGET	---, 50 to 230°F (10.0 to 110.0°C)	Central heating target as determined by outdoor air reset. "---" is displayed if there is not a central heating call.
DOMESTIC HOT WATER TARGET	---, 50 to 230°F (10.0 to 110.0°C)	Domestic hot water heating target. "---" is displayed if there is not a DHW call.
SETPOINT TARGET	---, 50 to 230°F (10.0 to 110.0°C)	Setpoint heating target. "---" is displayed if there is not a Constant Setpoint or Remote Setpoint call.
OUTDOOR TEMPERATURE SENSOR	---, -85 to 149°F (-65.0 to 65.0°C)	Current outdoor temperature as measured by the outdoor sensor. "---" is displayed if there is no sensor available or there is a sensor fault.
DOMESTIC HOT WATER TANK	---, 32 to 266°F (0.0 to 130.0°C)	Current indirect DHW tank temperature as measured by the DHW sensor. "---" is displayed if there is no sensor connected or there is a sensor fault.
PRESSURE SENSOR	0 to 150 psi (0 to 1034 kPa)	Current system pressure as measured by the pressure sensor. This item is only available if the Pressure Sensor is ON. "---" is displayed if there is no sensor connected or there is a sensor fault.
BOILER 1 TO 16 STATUS		
FIRING RATE	0 to 100%	Current firing rate of the boiler. Applies to all boiler types except when using the EMS output signal.
TARGET TEMPERATURE	50 to 230°F (10.0 to 110.0°C)	Current temperature target of the boiler. Applies only to boilers using the EMS output signal.
HOURS	0 to 999999 hours	Counts the number of hours that the boiler has fired since the parameter was last cleared.
CYCLES	0 to 99999 cycles	Counts the number of boiler cycles since the parameter was last cleared.

Settings (1 of 8)

Parameter	Range	Description
UNITS		
TEMPERATURE	°F or °C Default: °F	Units for display of temperature.
PRESSURE	psi or kPa Default: psi	Units for display of pressure.
DATE AND TIME		
24-HOUR TIME	Off or On Default: Off	Selects a 24 hour time clock.
SET AUTOMATICALLY	Off or On Default: On	Automatic synchronizes the time with the Internet.
TIME ZONE	North American Time Zones Default: Eastern	Select from Newfoundland, Atlantic, Eastern, Central, Mountain, Pacific, Alaska, Hawaii time zones.
DATE	Month, Day, Year	Set the current date. Available when setting time manually.
TIME	Hours, Minutes, AM/PM	Set the current time. Available when setting time manually.
DAYLIGHT SAVINGS	Off or On Default: On	Select if daylight savings time is locally observed.
INTERNET		
CONNECTION TYPE	Off, Ethernet, Wi-Fi Default: Off	Select the Internet connection.
WI-FI NETWORK	Scans for all available networks	Select the desired Wi-Fi network SSID. Then enter the Wi-Fi password.
WATTS ONSITE	Register or Deregister	Register the control with Watts OnSite to use the web or mobile apps.
IP CONFIGURATION	DHCP or Static Default: DHCP	Select if the control should receive an automatic IP address from the router DHCP server or use a static IP address.
IP ADDRESS	0.0.0.0 to 255.255.255.255 Default: 192.168.0.1	Set the static IP address. Available when IP Configuration is Static.
SUBNET MASK	0.0.0.0 to 255.255.255.255 Default: 255.255.255.0	Set the static IP address. Available when IP Configuration is Static.
ROUTER	0.0.0.0 to 255.255.255.255 Default: 192.168.1.1	Set the router or gateway IP address. Available when IP Configuration is Static.
DNS 1	0.0.0.0 to 255.255.255.255 Default: 0.0.0.0	Set the control's primary DNS. 0.0.0.0 uses the factory default DNS servers.
DNS 2	0.0.0.0 to 255.255.255.255 Default: 0.0.0.0	Set the control's secondary DNS. 0.0.0.0 uses the factory default DNS servers.

Settings (2 of 8)

Parameter	Range	Description
HEATING CALLS > CENTRAL HEATING		
CENTRAL HEATING	Off or On Default: Off	Select if the control responds to central heating calls. When connected to a tekmarNet system, this setting is forced on and not visible.
ROOM OCCUPIED	35 to 100°F (2.0 to 38.0°C) Default: 70°F (21.0°C)	Set the desired room air temperature during the occupied periods.
ROOM UNOCCUPIED	35 to 100°F (2.0 to 38.0°C) Default: 65°F (18.5°C)	Set the desired room air temperature during the unoccupied periods. This item is only available when Schedule > Device Schedule is On.
TERMINAL UNIT	Radiant Floor, Baseboard, Radiator, Fan Coil Default: Baseboard	Set the type of terminal units that are being used for the space heating system.
BOILER START TEMPERATURE	35 to 100°F (2.0 to 38.0°C) Default: 70°F (21.0°C)	Set the starting boiler water temperature for the heating curve.
OUTDOOR START TEMPERATURE	35 to 100°F (2.0 to 38.0°C) Default: 70°F (21.0°C)	Set the starting outdoor temperature for the heating curve.
OUTDOOR DESIGN TEMPERATURE	-60 to 45°F (-51.0 to 7.0°C) Default: 10°F (-12.0°C)	Set the coldest outdoor air temperature for the heating curve for the coldest day of the year.
BOILER DESIGN TEMPERATURE	50 to 230°F (10.0 to 110.0°C) Default: 180°F (82.0°C)	Set the boiler supply water temperature for the heating curve on the typical coldest day of the year.
WARM WEATHER SHUT DOWN	Off or On Default: Off	Select if the control should shut down the central heating based on the outdoor air temperature.
WARM WEATHER SHUT DOWN OCCUPIED	35 to 100°F (2.0 to 38.0°C) Default: 70°F (15.5°C)	Set the outdoor air temperature at which the central heating is shut off during the occupied period.
WARM WEATHER SHUT DOWN UNOCCUPIED	35 to 100°F (2.0 to 38.0°C) Default: 60°F (21.0°C)	Set the outdoor air temperature at which the central heating is shut off during the unoccupied period.
HEATING CALLS > DOMESTIC HOT WATER		
DHW	Off or On Default: On	Select if the control responds to domestic hot water heating calls.
DHW TYPE	System, Side Arm, Dedicated Default: System	Set the type of DHW heating. System refers to the DHW tank being located on the system loop. Side Arm refers to the DHW tank being located on boiler 1 on the near boiler piping. Dedicated refers to a system with only DHW heating loads.
DHW SENSOR	Off or On Default: Off	Select if a sensor measures the DHW tank temperature for configurations where DHW Type is System. The DHW Sensor is mandatory in Side Arm and Dedicated applications.
DHW TANK OCCUPIED	50 to 230°F (10.0 to 110.0°C) Default: 140°F (60.0°C)	Set the DHW tank temperature during the occupied period. Available when a DHW Sensor is set On.

Settings (3 of 8)

Parameter	Range	Description
DHW TANK UNOCCUPIED	50 to 230°F (10.0 to 110.0°C) Default: 130°F (54.5°C)	Set the DHW tank temperature during the unoccupied period. Available when DHW Sensor is set On.
DHW TANK DIFFERENTIAL	1 to 42°F (0.5 to 23.5°C) Default: 6°F (3.5°C)	Set the DHW tank differential. The DHW call turns on when the temperature reaches the DHW Tank Occupied/Unoccupied setpoint minus the DHW Tank Differential. Available when DHW Sensor is set On.
DHW EXCHANGE OCCUPIED	50 to 230°F (10.0 to 110.0°C) Default: 180°F (82.0°C)	Set the boiler water heat exchanger temperature to heat the indirect DHW tank during the occupied period. Available when DHW Sensor is set Off.
DHW EXCHANGE UNOCCUPIED	Off or On Default: Off	Select if the DHW tank is heated during the unoccupied period. Available when DHW Sensor is set Off.
INDIRECT DHW PRIORITY	Off or On Default: Off	Select if the indirect DHW tank has priority over the central heating load.
INDIRECT DHW PRIORITY OVERRIDE	20 to 240 minutes Default: 240 minutes	Set the DHW priority override time after which central heating is resumed. Available when Indirect DHW Priority is On.
INDIRECT DHW SYSTEM PUMP	Off or On Default: Off	Select if the system pump should operate during an indirect DHW call. Available when DHW Type is System.
INDIRECT DHW BOILER LIMITING	1 to 16 Default: 2	Set the maximum number of boilers to respond to a DHW call. The limit does not apply when there are simultaneous central heating or setpoint calls.
HEATING CALLS > CONSTANT SETPOINT		
CONSTANT SETPOINT	Off or On Default: Off	Select if there are constant setpoint heating loads.
CONSTANT SETPOINT OCCUPIED	50 to 230°F (10.0 to 110.0°C) Default: 180°F (82.0°C)	Set the constant setpoint during the occupied period. Available when Constant Setpoint is On.
CONSTANT SETPOINT UNOCCUPIED	Off or On Default: Off	Select if the Constant Setpoint call is heated during the unoccupied period.
CONSTANT SETPOINT SYSTEM PUMP	Off or On Default: Off	Select if the system pump should operate during a Constant Setpoint call.
HEATING CALLS > REMOTE SETPOINT		
REMOTE SETPOINT	Off or On Default: Off	Select if there are remote setpoint heating loads. Note: When set on, the outdoor air sensor input changes to measure an EMS analog signal input.
INPUT EMS SIGNAL	0-10 or 2-10 Default: 0-10	Set the EMS analog signal range. Available when Remote Setpoint is On.
INPUT EMS OFFSET	-10 to 10°F (-5.5 to -5.5°C) Default: 0°F (0.0°C)	Set the offset from the boiler target temperature interpreted from the EMS analog input signal. Available when Remote Setpoint is On.
BOILERS 1 TO 16		
BOILER AVAILABLE	Off or On Default: Off	Select if the boiler is available as part of the firing sequence. The boiler should be set Off if not in use or the boiler is off line for maintenance.

Settings (4 of 8)

Parameter	Range	Description
BOILER MANUFACTURER	Based on presets file Default: Custom	Select the boiler manufacturer. Choose Custom if the installed boiler is not included in the list.
BOILER SERIES	Based on presets file	Select the boiler series. Available when a boiler manufacturer name is selected.
BOILER MODEL	Based on presets file	Select the boiler model. Available when a boiler manufacturer name is selected.
BOILER FUEL	NG Gas, LP Gas, Oil, Electric, Wood	Set the boiler's fuel type.
BOILER TYPE	1-Stage, 2-Stage, 3-Stage, 4-Stage, Modulating Fire Rate, Modulating Target Temperature	Select if the boiler has multiple stages or is modulating. Both modulating firing rate and target temperature is supported.
BOILER GROUP	Condensing or Non-Condensing Default: Non-condensing	Select which boiler group the boiler should belong. This supports hybrid boiler systems that have both condensing and non-condensing boilers.
BOILER MASS	Low, Medium, High, Very High	Set the boiler's mass. This setting changes the PID staging operation. Setting a higher mass makes the time delay between boiler stages longer.
FIRE DELAY	10 to 180 seconds Default: 30 seconds	Set the fire delay time. This is the time duration from when the control provides an enable signal to when the boiler completes ignition.
BOILER HIGH OUTPUT	10 to 9990 MBTU/h Default: 400 MBTU/h	Set the boiler burner's BTU output at full fire. Units are in thousands of BTUs per hour.
MODULATION TYPE	0-10Vdc, 4-20 mA Default: 0-10 Vdc	Set the type of analog signal received by the boiler to modulate the firing rate or target temperature.
BOILER LOW OUTPUT	10 to 9990 MBTU/h Default: 80 MBTU/h	Set the boiler burner's BTU output at low fire. Units are in thousands of BTUs per hour.
MODULATION DELAY	0 to 180 seconds Default: 0 seconds	Set the modulation delay time. This is the time that the boiler burner modulation is held at low fire.
MODULATION MOTOR SPEED	10 to 230 seconds Default: 30 seconds	Set the modulation motor speed. This is the time required to change from low to high fire.
START MODULATION	0 to 50% Default: 0%	Set the starting modulation rate during boiler ignition.
MINIMUM MODULATION	0 to 50% Default: 0%	Set the low fire modulation rate.
MAXIMUM MODULATION	50 to 100% Default: 100%	Set the high fire modulation rate.
OUTPUT EMS SIGNAL MINIMUM	0.5 to 10.0 Vdc Default: 1.0 Vdc	Set the EMS output signal minimum DC voltage to the boiler.
EMS TEMPERATURE MINIMUM	50 to 210°F (10.0 to 99.0°C) Default: 50°F (10.0°C)	The EMS signal operates on a linear scale. Set the temperature when the EMS signal is at the lowest output.
EMS TEMPERATURE MAXIMUM	50 to 210°F (10.0 to 99.0°C) Default: 210°F (99.0°C)	The EMS signal operates on a linear scale. Set the temperature when the EMS signal is at the highest output of 10 Vdc or 20 mA.

Settings (5 of 8)

Parameter	Range	Description
POST PURGE	0.0 to 20.0 minutes Default: 2.0 minutes	Set the boiler pump post purge time after the burner has shut off.
SYSTEM		
BOILER MINIMUM	50 to 230°F (10.0 to 110.0°C) Default: 140°F (60.0°C)	The minimum allowed boiler target temperature used for the non-condensing boiler group. Check the boiler manufacturer's manual for recommended minimum boiler supply temperatures. This setting is applicable if there is at least one boiler available in the non-condensing boiler group.
BOILER MAXIMUM	50 to 230°F (10.0 to 110.0°C) Default: 200°F (93.0°C)	The maximum allowed boiler target temperature.
STAGING	PID or Proportional	Set either PID or Proportional staging. PID staging is recommended for central heating while Proportional staging is recommended for dedicated DHW applications.
PID AUTO DIFFERENTIAL	Off or On Default: On	Select if automatic PID differential is used. Available when using PID staging.
PID MANUAL BOILER DIFFERENTIAL	2 to 42°F (1.0 to 23.5°C) Default: 10°F (5.5°C)	Set the manual PID boiler differential. Available when using PID staging and PID Auto Differential is Off.
PID AUTOMATIC STAGE DELAY	Off or On Default: On	Select if automatic PID staging is used. Available when using PID staging.
PID MANUAL STAGE DELAY	0.5 to 40.0 minutes Default: 6.0 minutes	Select the manual PID staging delay between boilers or boiler stages. Available when using PID staging and PID Automatic Stage Delay is Off.
PROPORTIONAL INTERSTAGE DIFFERENTIAL	1 to 10°F (0.5 to 5.5°C) Default: 4°F (2.0°C)	Set the temperature differential required to turn on the next boiler or next boiler stage. Available when using Proportional staging.
PROPORTIONAL INTERSTAGE ON DELAY	0.5 to 10.0 minutes Default: 1.0 minutes	Set the boiler run time required before turning on the next boiler or the next boiler stage. Available when using Proportional staging.
PROPORTIONAL INTERSTAGE OFF DELAY	0.5 to 10.0 minutes Default: 0.5 minutes	Set the boiler off time required before turning on the same boiler or the same boiler stage again. Available when using Proportional staging.
MINIMUM STAGE RUN TIME	0.5 to 10.0 minutes Default: 0.5 minutes	Set the minimum boiler run time required when a boiler or boiler stage is turned on. Available when using Proportional staging.
MINIMUM STAGE OFF TIME	0.5 to 10.0 minutes Default: 0.5 minutes	Set the minimum boiler off time required when a boiler or boiler stage is turned off before it is allowed to turn back on. Available when using Proportional staging.
CONDENSING GROUP SEQUENCING	Sequential or Parallel Default: Sequential	Select to use sequential or parallel boiler staging for condensing boilers.
NON-CONDENSING GROUP SEQUENCING	Sequential or Parallel Default: Sequential	Select to use sequential or parallel boiler staging for non-condensing boilers.
CONDENSING GROUP ROTATION	Off or On Default: On	Select if equal runtime rotation is used for condensing boilers.
NON-CONDENSING GROUP ROTATION	Off or On Default: On	Select if equal runtime rotation is used for non-condensing boilers.

Settings (6 of 8)

Parameter	Range	Description
FIXED LEAD	Off or On Default: Off	Select if boiler 1 is always the first boiler to fire. This feature is useful in cases whereby boiler 1 primes the flue gas venting.
FIXED LEAD TYPE	First On/First Off or First On/Last Off Default: First On/Last Off	Select if boiler 1 is the first on/first off or first on/last off. Available when Fixed Lead is On.
FIXED LAST	Off or On Default: Off	Select if the last available boiler is always the last to fire. When using a 294 the last boiler is 4. If there is one 294EXP expansion then the last boiler is 8. If there are two 294EXP expansions then the last boiler is 12. If there are three 294EXP expansions then the last boiler is 16.
COMBUSTION AIR DELAY	0 to 360 seconds Default: 0 seconds	Set the time that the combustion air damper is open before turning on the first boiler.
VARIABLE PRIMARY FLOW	Boiler pumps or Isolation valves Default: Off	Select if the boilers each have a boiler pump or if there is a variable speed system pump with isolation valves per boiler.
OUTDOOR SENSOR	Control, tekmarNet, Internet Default: Off	Set the source of the outdoor air sensor reading. tekmarNet is available when connected to a tekmarNet communication system. Internet is available when connected to the Internet through Ethernet or Wi-Fi.
PRESSURE SENSOR	Off or On Default: Off	Select if a pressure sensor is installed.
EXERCISING	Off or On Default: Off	Select if the control should exercise the pumps and valves every 72 hours to prevent seizure.
BOILER MODBUS	Off or On Default: Off	Select if the control is connected to the boilers using Modbus communication.
ALERTS		
HIGH BOILER TEMPERATURE ALERT	50 to 230°F (10.0 to 110.0°C) Default: 230°F (110.0°C)	Set the threshold above which the control triggers a high temperature alert notification.
LOW BOILER TEMPERATURE ALERT	50 to 230°F (10.0 to 110.0°C) Default: 50°F (10.0°C)	Set the threshold below which the control triggers a low temperature alert notification.
BOILER PLANT NO HEAT ALERT	0.5 to 80.0 minutes Default: 10.0 minutes	Set the amount of time of no temperature change while boilers are firing after which the control triggers a boiler plant no heat alert notification.
HIGH PRESSURE ALERT	0 to 150 psi (0 to 1050 kPa) Default: 50 psi (1050 kPa)	Set the threshold above which the control triggers a high pressure alert notification.
LOW PRESSURE ALERT	0 to 150 psi (0 to 1050 kPa) Default: 0 psi (0 kPa)	Set the threshold below which the control triggers a low pressure alert notification.

Settings (7 of 8)

Parameter	Range	Description
BOILER 1 SERVICE HOURS ALERT	1000 to 25000 hours Default: 5000 hours	Set the number of boiler running hours above which the control triggers a boiler service alert notification.
BOILER 1 SERVICE CYCLES ALERT	1 to 25000 cycles Default: 25000 cycles	Set the number of boiler on/off cycles above which the control triggers a boiler service alert notification.
BOILER SERVICE HOURS AND CYCLES REPEATED FOR BOILERS 2 TO 4		
BOILER 5 SERVICE HOURS ALERT	1000 to 25000 hours Default: 5000 hours	Set the number of boiler running hours above which the control triggers a boiler service alert notification. Available when connected to a 294EXP expansion control.
BOILER 5 SERVICE CYCLES ALERT	1 to 25000 cycles Default: 25000 cycles	Set the number of boiler on/off cycles above which the control triggers a boiler service alert notification. Available when connected to a 294EXP expansion control.
BOILER SERVICE HOURS AND CYCLES REPEATED FOR BOILERS 6 TO 8		
BOILER 9 SERVICE HOURS ALERT	1000 to 25000 hours Default: 5000 hours	Set the number of boiler running hours above which the control triggers a boiler service alert notification. Available when connected to two 294EXP expansion controls.
BOILER 9 SERVICE CYCLES ALERT	1 to 25000 cycles Default: 25000 cycles	Set the number of boiler on/off cycles above which the control triggers a boiler service alert notification. Available when connected to two 294EXP expansion controls.
BOILER SERVICE HOURS AND CYCLES REPEATED FOR BOILERS 10 TO 12		
BOILER 13 SERVICE HOURS ALERT	1000 to 25000 hours Default: 5000 hours	Set the number of boiler running hours above which the control triggers a boiler service alert notification. Available when connected to three 294EXP expansion controls.
BOILER 13 SERVICE CYCLES ALERT	1 to 25000 cycles Default: 25000 cycles	Set the number of boiler on/off cycles above which the control triggers a boiler service alert notification. Available when connected to three 294EXP expansion controls.
BOILER SERVICE HOURS AND CYCLES REPEATED FOR BOILERS 14 TO 16		
COMMISSIONING WIZARD		
STEP 1	All equipments is off.	
STEP 2	Combustion air damper is open.	
STEP 3	System pump is on.	
STEP 4	DHW pump is on. This only applies if DHW is enabled.	
THE FOLLOWING STEPS ARE REPEATED FOR EACH AVAILABLE BOILER 1 TO 16		
STEP 5A	Boiler pump or valve is on.	
STEP 5B	Boiler enable is on.	
STEP 5C	Boiler set to Start Mod. This only applies to modulating firing rate boilers.	
STEP 5D	Boiler Mod is set to 180°F. This only applies to modulating temperature target boilers.	
STEP 5E	Boiler is off.	

Settings (8 of 8)

Parameter	Range	Description
STEP 5 IS REPEATED FOR EACH AVAILABLE BOILER 2 TO 16		
STEP 6		Commission wizard ends and all outputs are turned off.

A Commissioning Report is provided at the end of the commissioning wizard.

The  indicates that step was completed successfully.

The  indicates that step was incomplete and corrective action is required.

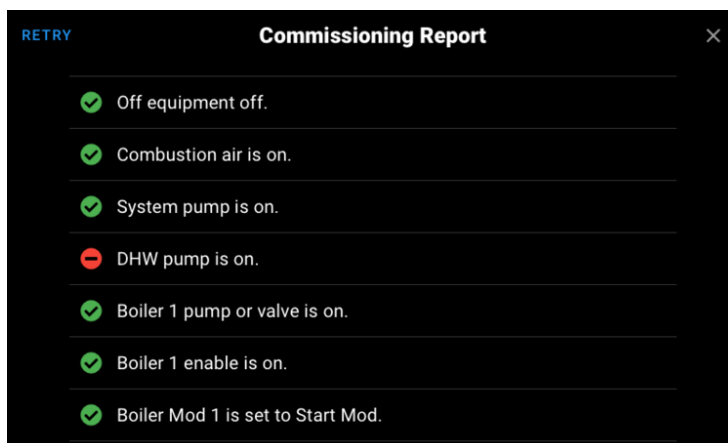

Parameter	Range	Description
SECURITY		
STEP 1		Set a personal passcode. This is required when a passcode has already been set.
STEP 2		Confirm the personal passcode. This is required when a passcode has already been set.
REQUIRE PASSCODE	Off or On Default: Off	Select if a passcode is required to enter the Home screen.
PASSCODE		Select to change the personal passcode.
RESET		
FACTORY RESET		Select to load factory defaults for all settings. This does not deregister the control from the Watts OnSite application.
TEKMARNET DEVICE RESET		Select to reset the tekmarNet communications. This removes any lost tN4 devices from the control.

Schedule Menu

The control can follow an internal schedule to provide energy savings during unoccupied periods.

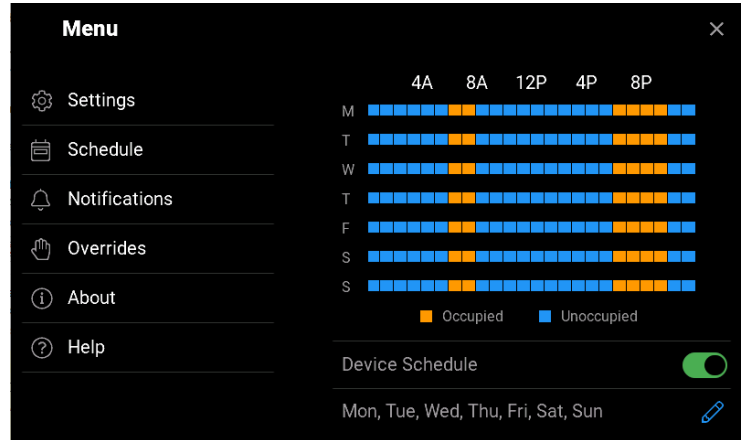

When creating a new schedule, choose the days that share the same occupied and unoccupied time periods.

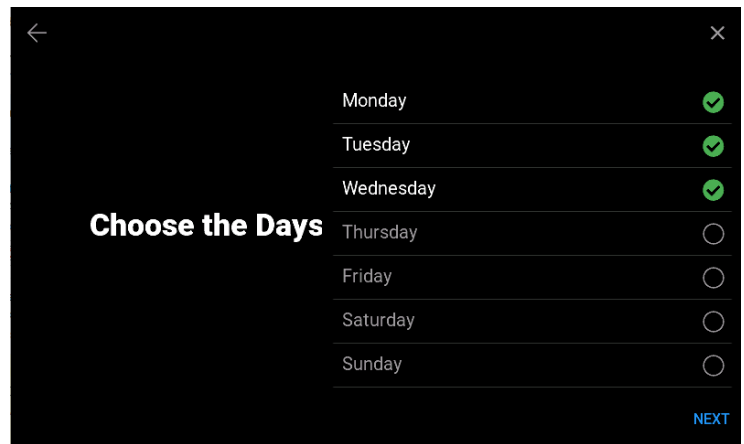

Parameter	Range	Description
OCCUPIED 1 TIME	12:00 am to 12:50 pm (0:00 to 23:50) Default: 6:00 am (6:00)	Set the occupied 1 time. Select "SKIP" to ignore the occupied 1 time event.
UNOCCUPIED 1 TIME	12:00 am to 12:50 pm (0:00 to 23:50) Default: 8:00 am (8:00)	Set the unoccupied 1 time. Select "SKIP" to ignore the unoccupied 1 time event.
OCCUPIED 2 TIME	12:00 am to 12:50 pm (0:00 to 23:50) Default: 6:00 pm (18:00)	Set the occupied 2 time. Select "SKIP" to ignore the occupied 2 time event.
UNOCCUPIED 2 TIME	12:00 am to 12:50 pm (0:00 to 23:50) Default: 10:00 am (22:00)	Set the unoccupied 2 time. Select "SKIP" to ignore the unoccupied 2 time event.

Notifications Menu

The control keeps track of the last 30 errors and alert notifications.

Refer to the Troubleshooting section for corrective action.

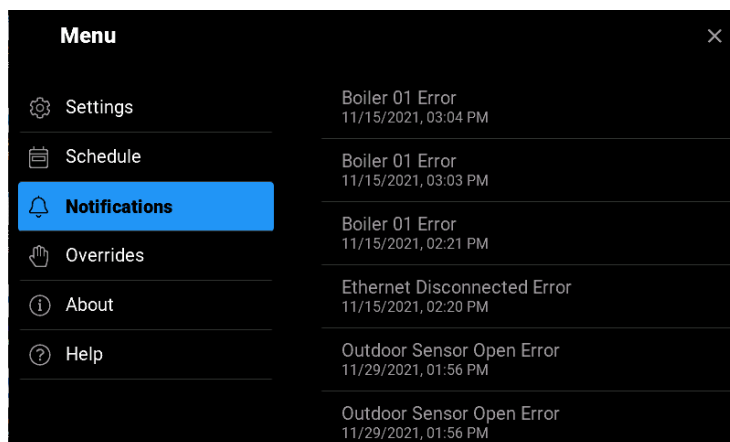

Overrides Menu

Parameter	Range	Description
OPERATION	Automatic, Hand, Purge, Max Heat, Off	Set the manual override. Automatic reverts to normal operation. Hand allows each output to be turned on or set manually. Purge turns on the pumps to remove air from the system. No boilers are fired. Max Heat operates the heating system at the boiler maximum setting. Off places the control into a standby state and the boilers and pumps are not operated.
COMBUSTION AIR DAMPER	Off or On Default: Off	Select to turn on the combustion air damper. Available in Hand override.
SYSTEM PUMP	Off or On Default: Off	Select to turn on the system pump. Available in Hand override.
DHW PUMP	Off or On Default: Off	Select to turn on the DHW pump. Available in Hand override.
FOR EACH BOILER 1 TO 16		
BOILER PUMP	Off or On Default: Off	Select to turn on the boiler pump. Available in Hand override when Variable Primary Flow is set to Boiler Pumps.
BOILER ISOLATION VALVE	Off or On Default: Off	Select to turn on the boiler isolation valve. Available in Hand override when Variable Primary Flow is set to Isolation Valves.
MODULATION	0 to 100% Default: 0%	Set the boiler modulation firing rate signal to fire the boiler. Available in Hand override when Boiler Type is Modulating Firing Rate.
MODULATION	50 to 230°F (10.0 to 110.0°C) Default: 50°F (10.0°C)	Set the boiler modulation target temperature signal to fire the boiler. Available in Hand override when Boiler Type is Modulating Target Temp.
STAGES	Stage 1, Stage 2, Stage 3, Stage 4	Set the boiler stage on. Available in Hand override when Boiler Type is 1-Stage, 2-Stage, 3-Stage or 4-Stage.

Override Menu

Commissioning, testing and troubleshooting features of the 294 are accessed through the Override menu. The Manual Override has five different modes including:

Automatic

The normal operating mode for the control is automatic.

Purge Override

In this mode, the control overrides the normal operating mode and operates pumps. This mode is useful for purging air out of the system.

- System pump is turned on.
- DHW pump: operation of the DHW pump is dependent on the settings in the Domestic Hot Water Call menu.
- Purge will operate for a fixed period of 72 hours. After the purge period expires the control will revert to Automatic operation. The purge override can also be terminated by selecting automatic.

Max Heat Override

In this mode, the control overrides the normal operating mode and operates the system to maintain the boiler maximum target. This function is useful on start-up, commissioning, and also when drying sheet rock and paint in the building.

- Operation of the equipment is dependent on the system.
- WWSD, DHW and Setpoint Priority are disabled during Max Heat.
- Max Heat will operate for 1 hour. After the timeout period elapses the control will revert back to Automatic mode. The max heat override can also be terminated by selecting automatic.

Hand Override

In this mode, the control overrides the normal operating mode allows for manual operation of the equipment. This mode is useful for testing and assisting with troubleshooting.

- Operation of the equipment is dependent on the settings in the Settings menu.
- Hand mode will operate for 1 hour. After the timeout period elapses the control will revert back to Automatic mode. The hand override can also be terminated by selecting automatic.

Off Override

In this mode, the control overrides the normal operating mode and forces the entire system into standby. This mode is useful for conducting maintenance or change out of mechanical components in the system.

- The Off override can be terminated at any time by selecting automatic.

About Menu

The About menu lists all details about the control. This information may be required when contacting tekmar for support.

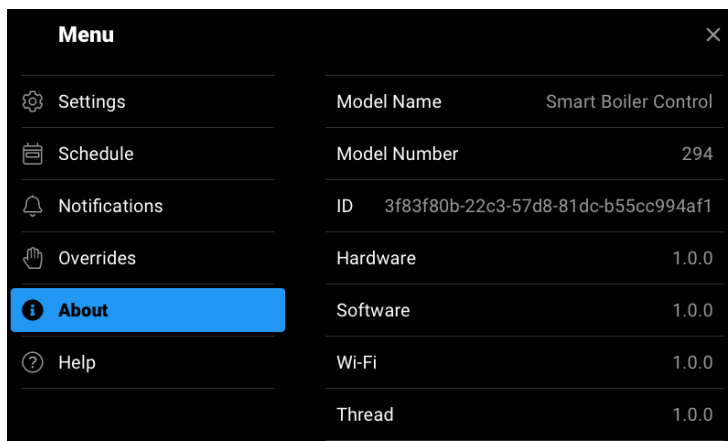

Help Menu

Scan the QR code with your mobile phone to be directed to the product website to find specifications, manuals, and videos.

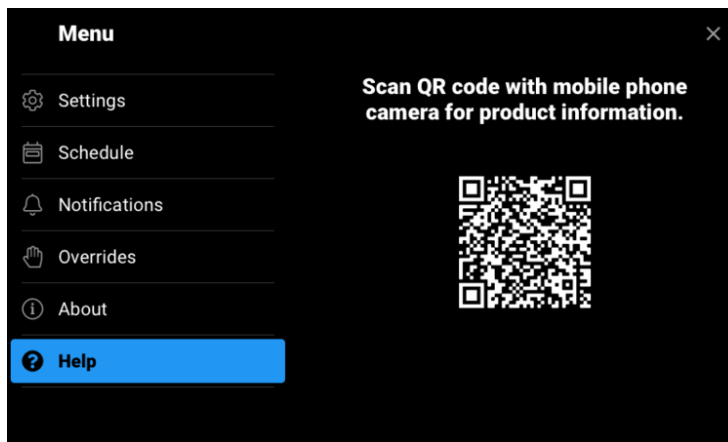

Sequence of Operation

Heating Calls

When powered on and in automatic mode, the control remains in standby until it receives a heating call from one of the following inputs:

- Central heating call
- Domestic hot water call
- Setpoint call
- tekmarNet call

Once a call is received, the control displays a boiler target and the control starts the boiler firing sequence. The heating calls are visible on the System Inputs screen on the control.

Central Heating Operation

A central heating call is created when a contact closure or 24 V (ac) signal is applied across the Heat Call terminals.

Central heating calls use outdoor temperature reset to calculate the boiler target. This weather responsive feature reduces energy consumption by up to 30% compared to operating the boilers at a fixed setpoint. The boiler target is calculated using the following factors:

- Room temperature occupied (default: 70°F, 21.0°C) or unoccupied (default: 65°F, 18.5°C)
- Outdoor air temperature
- Outdoor start temperature (default: 70°F, 21.0°C)
- Boiler start temperature (default: 70°F, 21.0°C)
- Outdoor design temperature (default: 10°F, -12.0°C)
- Boiler design temperature (default: 180°F, 82.0°C)

As the outdoor air temperature gets colder, the boiler target is automatically ramped up to match the additional heat loss of the building using a heating curve.

use by automatically lowering the heating curve and lowering the boiler target temperatures.

Outdoor Start

This setting determines the outdoor air temperature starting point of the heating curve.

Boiler Start

This setting determines the boiler temperature starting point of the heating curve.

Outdoor Design

This setting determines the outdoor air temperature at which the highest boiler water temperature is required. This is typically set to the coldest outdoor air temperature for your local region.

Boiler Design

This setting determines the highest boiler temperature required to heat the building based upon the Heating Terminal Unit type.

Heating Terminal Unit

The Heating Terminal Unit changes the shape of the characterized heating curve to better match the heat transfer properties of that specific terminal unit.

Radiant Floor

A hydronic radiant floor is embedded in either a concrete pour or stapled up in the floor joist. This heating system has a large thermal mass and is slow acting.

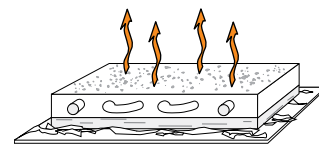
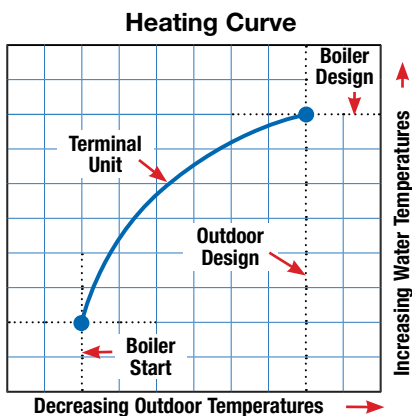

Room Occupied and Unoccupied

Increasing the Room Temperature setting shifts the heating curve upwards; therefore calculating higher boiler target temperatures. Likewise, decreasing the Room Temperature setting shifts the heating curve downwards; therefore calculating lower boiler target temperatures. When using a programmable schedule, the Room Temperature Unoccupied reduces energy

Baseboard

A baseboard or convector terminal unit is made up of a heating element with fins on it. This type of terminal unit relies on the natural convection of air across the heating element to deliver heated air into the space. The amount of natural convection is dependent on the supply water temperature to the heating element and the room air temperature.

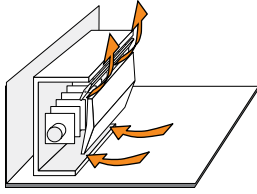

Radiator

A radiator terminal unit has a large heated surface that is exposed to the room. A radiator provides heat to the room through radiant heat transfer and natural convection.

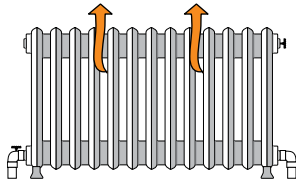

Fancoil

A fancoil terminal unit or air handling unit (AHU) consisting of a hydronic heating coil and either a fan or blower. Air is forced across the coil at a constant velocity by the fan or blower and is then delivered into the building space.

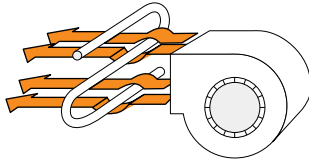

Terminal Unit Defaults

When a terminal unit is selected the control loads default values for the boiler design, boiler maximum supply, and boiler minimum supply temperatures. The factory defaults can be changed to better match the installed system. Locate the Terminal Unit setting in the Central Heating menu.

TERMINAL UNIT	BOILER DESIGN	BOILER MAX	*BOILER MIN
Radiant Floor	120°F (49.0°C)	140°F (60.0°C)	140°F (60.0°C)
Baseboard	180°F (82.0°C)	200°F (93.5°C)	140°F (60.0°C)
Radiator	160°F (71.0°C)	180°F (82.0°C)	140°F (60.0°C)
Fancoil	190°F (88.0°C)	210°F (99.0°C)	140°F (60.0°C)

The Boiler Minimum is not applied when the boiler is assigned to the Condensing boiler group.

Warm Weather Shut Down (WWSD)

When the outdoor air temperature exceeds the Warm Weather Shut Down (WWSD) setting by 1 °F (0.5 °C), the central heating call is disabled and the central heating system is automatically shut off. When the outdoor air temperature falls 1 °F (0.5 °C) below the WWSD the central heating call resumes and the heating system automatically turns on.

When the programmable schedule is on, the Room temperature unoccupied and the WWSD Unoccupied allow the central heating system to operate at a lower boiler target and result in additional energy savings.

Domestic Hot Water (DHW) Operation

DHW Call

A domestic hot water (DHW) call operates the boilers at a fixed temperature to heat a DHW storage tank. The DHW call status is displayed in the System Inputs on the display. A DHW call can be created in one of three ways:

DHW Tank Aquastat

If a DHW Tank Aquastat (mechanical switch) is used to apply a DHW Call, the tank is heated to the aquastat temperature setting. A dry contact or 24 V (ac) signal is applied across the DHW Call terminals.

DHW Sensor

A DHW Tank Sensor 078 (not included) is installed in a temperature well to measure the tank temperature. A DHW call is created when the tank temperature falls to the DHW Tank Occupied minus the DHW Differential. The DHW call is removed when the tank reaches the DHW Tank Occupied setpoint.

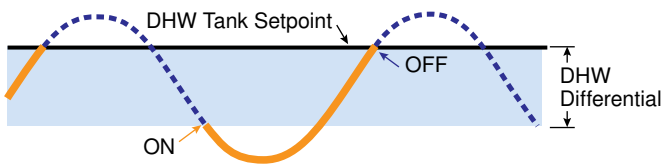

tekmarNet® Setpoint Control

A DHW call is provided through the tekmarNet® system by using a tekmarNet® Setpoint Control 161 or 162.

Boiler Target Temperature during a DHW Call

When a DHW Call is present, a boiler target is determined.

- When using a DHW tank aquastat, the boiler target is set to the DHW Exchange setting.
- When using a DHW tank sensor, the boiler target is fixed at the DHW Tank Occupied (or Unoccupied when using a schedule) setpoint plus 40°F (22.0°C).
- When using a tekmarNet® Setpoint Control, the boiler target is set to the device's Exchange Supply setting.

If there are multiple devices calling for heat, the boiler target is set to the highest temperature requirement.

Programmable Schedule and Away Scene

When the programmable schedule is On, additional setpoints for the unoccupied period become available.

When using a DHW tank aquastat, select DHW Exchange Unoccupied to On to heat, or select Off to not heat the DHW tank during the unoccupied time periods.

When using a DHW Sensor, the control heats to the DHW Tank Unoccupied setpoint.

During the Away scene, DHW calls are ignored.

DHW Application Type

The DHW Type setting selects the piping configuration. Three options are available:

- System
- Side Arm
- Dedicated

DHW Type System Operation

The indirect DHW tank is piped in the boiler system loop. When a DHW call is present, the DHW Pump turns on.

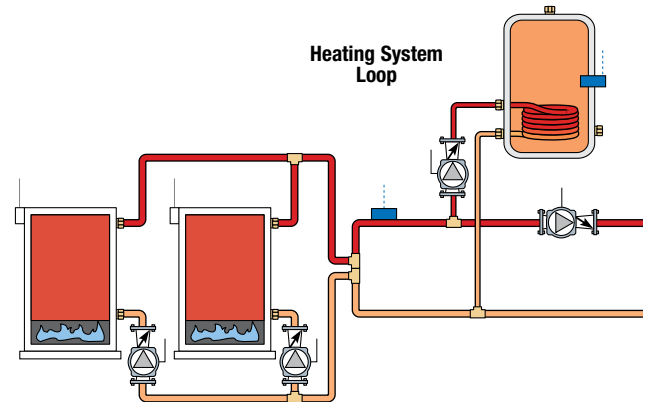

System Pump

The DHW System Pump setting selects the operation of the system pump during DHW calls.

Off

The system pump does not turn on during indirect DHW operation. Select Off when an indirect DHW tank is piped in parallel to the central heating system and located the boiler system loop.

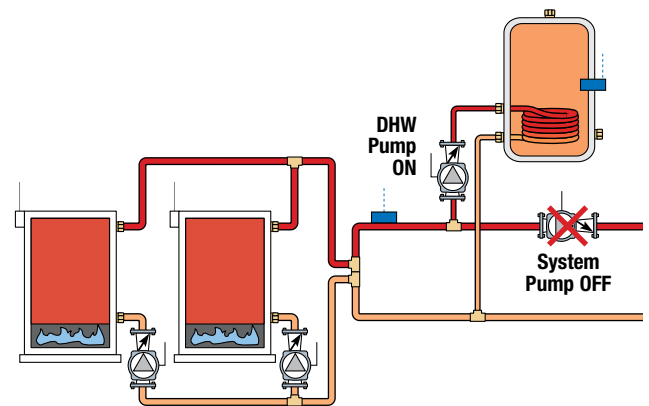

ON

The primary pump turns on during indirect DHW operation. Select On when the indirect DHW tank piped is piped in primary/secondary in the boiler system loop.

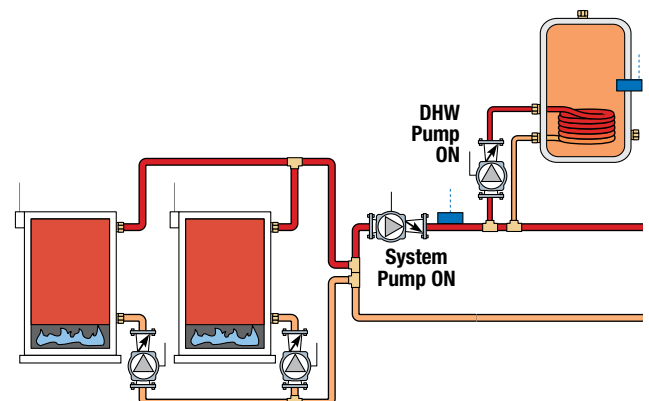

DHW Priority

The Indirect DHW Priority setting selects priority over the central heating system. This allows for quick recovery of the indirect DHW tank.

Off

DHW priority is not provided. The system pump operates when a Central Heating call is present.

On

When there are simultaneous DHW and central heating calls, the system pump shuts off to provide priority to the DHW tank.

When there are simultaneous DHW and tekmarNet calls, the system pump can continue to operate. If the boilers are unable to maintain the boiler target temperature, the tekmarNet zones are sequentially shut off using tekmarNet communication to provide priority. The sequence order shuts off the thermostat with address 24 first and address 1 last.

Priority Override

The control includes an Indirect DHW Priority Override to prevent the building from cooling off too much or a potential freezing condition in the event of a faulty DHW aquastat or sensor. The time is adjustable from 20 to 240 minutes. Once the allowed time for priority has elapsed, the control overrides the DHW priority and resumes central heating. DHW Priority does not resume until the central heating or DHW calls is removed and then reapplied.

Conditional DHW Priority

If the boiler supply temperature is maintained at or above the boiler target temperature during DHW operation, the DHW and central heating occurs simultaneously.

DHW Post Purge

After the DHW call is removed, the control performs a post purge. The control shuts off the boilers and continues to operate the DHW pump and the system pump to purge residual heat from the boilers into the DHW tank. The control continues this purge until one of the following conditions is met:

1. A heat call is detected.
2. The boiler supply drops 20°F (11.0°C) below the DHW target temperature.
3. The DHW tank temperature rises above the DHW setpoint plus ½ DHW Differential.
4. Two minutes elapse.

DHW Mixing Purge

After DHW operation, the boilers may be extremely hot. At the same time, the heating zones may have cooled off considerably after being off for a period of time. When restarting the heating system after a DHW Call with priority, the control shuts off the boiler and continues to operate the DHW pump while the system pump is turned on. This allows some of the DHW return water to mix with the cool return water from the zones and temper the boiler return water.

DHW with Radiant Floor Heating

If DHW heating is to be incorporated into a low temperature system such as a radiant floor heating system, a mixing device is often installed to isolate the high DHW supply temperature from the lower system temperature. If a mixing device is not installed, high temperature water could be supplied to the low

temperature system while trying to satisfy the DHW call. This may result in damage to the low temperature heating system.

The control is capable of providing DHW heating in such a system while minimizing the chance that the temperature in the heating system exceeds the design supply water temperature. In order to do this, the following conditions must be met:

- All available boilers are set to condensing.
- DHW Type set to System.
- Indirect DHW Priority set to On.
- tekmarNet system is present (If system pump during DHW operation is set to On)

On a DHW call, the control provides DHW priority by sending a message on the boiler temperature bus to the tekmarNet thermostats to shut off the heating zones for a period of time. The length of time is based on the outdoor air temperature, or selectable time, as described in the DHW Priority Override section. However, if the DHW call is not satisfied within the allotted time, the boiler shuts off and the heat of the boiler is purged into the DHW tank. A DHW mixing purge occurs in order to reduce the boiler water temperature and once the boiler supply temperature is sufficiently reduced, the DHW Pump contact shuts off. The heating system zones are allowed to turn on for a period of time to prevent the building from cooling off. After a period of heating, and if the DHW call is still present, the control shuts off the heating system and provides heat to the DHW tank once again.

DHW Boiler Limiting

The Indirect DHW Boiler Limiting settings restricts the number of boilers available for DHW heating to prevent unwanted boiler short cycling. This only applies when there is a DHW Call. If there is a Central Heating, Constant Setpoint or Remote Setpoint Call, the boiler limit is removed and all boilers are available.

DHW Type Side Arm Operation

The indirect DHW tank is piped in parallel within the near boiler piping of boiler 1. A DHW tank aquastat is used to create the DHW call, and a DHW sensor is used to regulate the boiler heat exchange water temperature, in order to prevent the boiler from tripping on it's internal maximum temperature limit. When a DHW call is present, the DHW pump turns on and boiler pump 1 turns off. This piping configuration provides simultaneous central heating and DHW tank heating with the DHW tank having the full capacity of boiler 1 heating output. Once the DHW tank call is satisfied, boiler 1 is shut off and there is a 2 minute DHW pump post purge, after which boiler 1 is available to resume central heating if required.

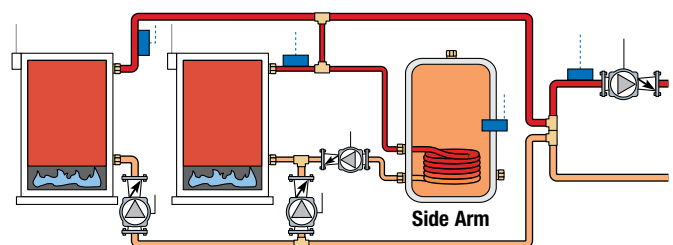

Dedicated Domestic Hot Water Operation

The control can operate water heaters to provide heat in an open-loop dedicated domestic hot water system. This is selected by setting DHW Type to Dedicated. When dedicated is selected, all other heating calls are disabled.

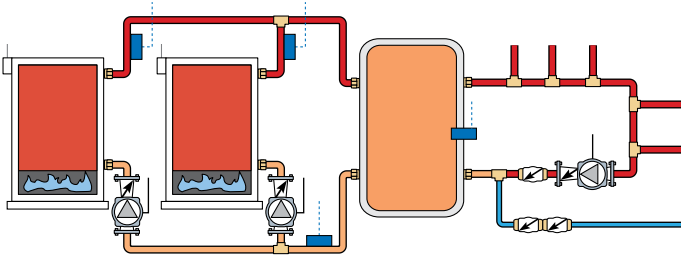

DHW Call

A DHW sensor installed in a temperature well to measure the tank temperature is used to create a DHW call. When the DHW sensor falls below the DHW Tank Occupied setpoint minus the Proportional Interstage Differential, a DHW call is displayed on the System Inputs screen.

Boiler Operation

The dedicated domestic hot water uses proportional staging for operating the water heaters. As the DHW tank temperature progressively drops, additional water heaters are staged on. Please refer to the System Operation for further information.

Programmable Schedule

When the programmable schedule is On, the DHW Tank Unoccupied is the setpoint during unoccupied time periods.

Constant Setpoint Operation

Setpoint Call

A setpoint call operates the boilers to a constant temperature setpoint. The setpoint call status is displayed in the System Inputs on the display. There are two ways to create a setpoint call:

Setpoint Call Input

A dry contact or 24 V (ac) signal is applied across the Setpoint Call terminals. The setpoint call operates at the Constant Setpoint Target.

tekmarNet® Setpoint Control

A tekmarNet® Setpoint Control 161 or 162 creates a call through tekmarNet communication bus. The setpoint target is determined by the setpoint control.

Programmable Schedule and Away Scene

When a programmable schedule is On, the Constant Setpoint Target Unoccupied selects if the control responds to setpoint calls during the unoccupied time period.

During the Away scene and the schedule is Off, the control responds to the Constant Setpoint call.

During the Away scene and the schedule is On, the Constant Setpoint Target Unoccupied selects if the control responds to setpoint calls.

System Pump

The Constant Setpoint System Pump setting selects whether or not the system pump is on during setpoint heating.

Off

The system pump does not turn on during setpoint heating. It is assumed that the setpoint load pump will provide adequate flow through the setpoint load and the boiler system loop.

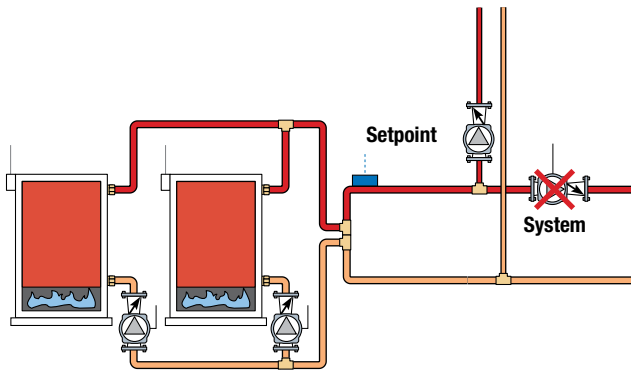

On

The system pump turns on during setpoint heating.

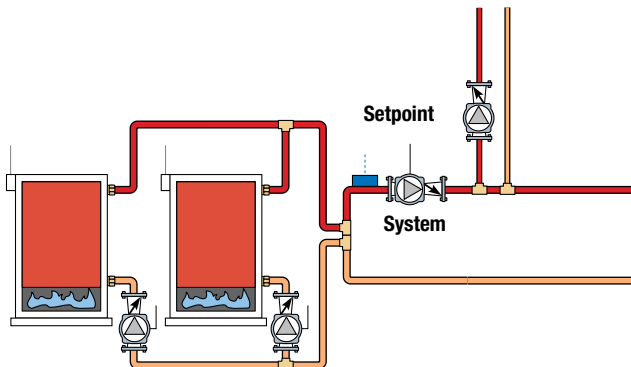

Setpoint Priority

The Constant Setpoint Priority setting selects whether or not priority of setpoint over central heating is required. Setpoint priority stops or limits the delivery of heat to the central heating system while the setpoint load calls for heat to allow for quick recovery of the load.

Off

Setpoint priority is not provided and the system pump can operate when a Heat Call is present.

On

Setpoint priority is provided over the central heating system.

When there are simultaneous constant setpoint and central heating calls, the system pump shuts off to provide priority to the setpoint load.

When there are simultaneous constant setpoint and tekmarNet calls, the system pump can continue to operate. If the boilers are unable to maintain the boiler target temperature, the tekmarNet zones are sequentially shut off using tekmarNet communication to provide priority. The sequence order shuts off the thermostat with address 24 first and address 1 last.

Priority Override

The control includes a Priority Override to prevent the building from cooling off too much or a potential freezing condition in the event of a faulty setpoint call signal. It uses the Indirect DHW Priority Override to determine the priority duration. The time is adjustable from 20 to 240 minutes. Once the allowed time for priority has elapsed, the control overrides the constant setpoint priority and resumes central heating. Setpoint priority does not resume until the central heating or setpoint calls are removed and then reapplied.

Conditional Setpoint Priority

If the boiler supply temperature is maintained at or above the required temperature during setpoint heating, this indicates that the boilers have enough capacity for setpoint and possibly central heating as well. As long as the boiler supply temperature is maintained near the target, setpoint and heating occurs simultaneously.

Setpoint Post Purge

After a Setpoint Call from a tekmarNet device is removed, the control performs a post purge. The control shuts off the boilers and continues to operate, if applicable, the system pump. This purges the residual heat from the boilers into the setpoint load. The control continues this purge until one of the following conditions are met:

1. A Heat Call is detected.
2. The boiler supply drops 20°F (11.0°C) below the setpoint target temperature.
3. Two minutes elapse.

Remote Setpoint Call

The control accepts an analog signal to create a Remote Setpoint Call when a 0-10 V(dc), 2-10 V(dc), or 4-20 mA signal is applied to the EMS (+) and EMS (-) wiring terminals. The control converts the analog signal into the appropriate boiler target temperature. The most common source of this analog signal is an Energy Management System (EMS). The Remote Setpoint Call is displayed in the System Inputs screen.

The remote setpoint call uses the same wiring terminals as the outdoor air sensor; therefore, the central heating call must be off when this feature is on.

0-10 V(dc) or 0-20 mA

When Input EMS signal is set to 0-10 V (dc), the control uses the following conversion table.

CONVERSION TABLE 0 - 10		
0 - 20 MA*	0 - 10 V (DC)	BOILER TARGET
0	0	--- (OFF)
2	1	50°F (10.0°C)
4	2	68°F (20.0°C)
6	3	86°F (30.0°C)
8	4	103°F (39.5°C)
10	5	121°F (49.5°C)
12	6	139°F (59.5°C)
14	7	157°F (69.5°C)
16	8	174°F (79.0°C)
18	9	192°F (89.0°C)
20	10	210°F (99.0°C)

*Requires 500 Ω Resistor in Parallel

If a voltage below 0.5 V (dc) is received the boiler target temperature is displayed as “---” indicating that there is no longer a call for heating.

A 0-20 mA signal can be converted to a 0-10 V (dc) signal by installing a 500 Ω resistor between the EMS (+) and EMS (-) terminals.

2-10 V(dc) or 4-20 mA

When Input EMS Signal is set to 2 - 10 V (dc), the control uses the following conversion table.

CONVERSION TABLE 2 - 10		
4 - 20 MA*	2 - 10 V (DC)	BOILER TARGET
0	0	--- (OFF)
4	2	50°F (10.0°C)
6	3	70°F (21.0°C)
8	4	90°F (32.0°C)
10	5	110°F (43.5°C)
12	6	130°F (54.5°C)
14	7	150°F (65.5°C)
16	8	170°F (76.5°C)
18	9	190°F (88.0°C)
20	10	210°F (99.0°C)

*Requires 500 Ω Resistor in Parallel

If a voltage below 1.5 V (dc) is received the boiler target temperature is displayed as “---” indicating that there is no longer a call for heating.

A 4-20 mA signal can be converted to a 2-10 V (dc) signal by installing a 500 Ω resistor between the EMS (+) and EMS (-) terminals.

EMS Offset

The analog voltage signal may drop over the length of a long wire. The Remote Setpoint includes an Input EMS Offset setting to compensate if the boiler target does not match the transmitting device.

Example

Range	= 0 - 10 V (dc)		157°F (69°C)
Input	= 7 V (dc)		
Offset	= +5°F (3°C)	→	+5°F (3°C)
Boiler Target	=		162°F (72°C)

tekmarNet® 4 Call

The control can communicate with tekmarNet® devices such as thermostats, snow melting controls and setpoint controls to maximize system efficiency and comfort. The devices call for heat on the boiler system water temperature.

Indoor Temperature Feedback

tekmarNet Thermostats use Indoor Temperature Feedback when connected to the 294 tekmarNet boiler bus. Indoor Temperature Feedback automatically identifies the highest heat loss thermostat and sets the central heating target so that this thermostat operates at 100% on time. The remaining zones have lower heat loss and operate at a lower duty cycle.

Device Count

The control counts all the tekmarNet devices and displays this in the Settings > Heating Calls > tekmarNet menu.

Scenes

The 294 responds to the following tekmarNet® scenes:

SCENE	RESPONSE
1	Occupied or Schedule
2	Away, operates Room at 62°F (16.5°C) and there is no DHW heating
3	Permanent Unoccupied
4	Occupied or Schedule
5	Occupied or Schedule
6	Temporary 3 hour Occupied
7	Temporary 3 hour Occupied
8	Temporary 3 hour Occupied

Boiler Operation

The 294 can operate four boilers and up to 16 boilers when used together with the three Smart Boiler Expansion 294EXP. Each boiler is configured individually to provide maximum flexibility.

Boiler Available

Select the boiler available to On to allow the boiler to be part of the staging sequence. Select Off if the boiler is being serviced or that boiler output is not used.

Boiler Manufacturer, Series and Model

The 294 includes presets for over 1600 boiler models. Select the manufacturer, series and then the model and the control loads the recommended presets for that specific boiler. The boiler settings can be changed if desired.

If the manufacturer, series or model of your boiler is not available, then set the Boiler Manufacturer to Custom.

tekmar is continually updating the supported boilers presets which is automatically updated when the 294 is connected to the Internet. It is recommended to connect the control to the Internet first if your boiler model is not available when first powered on.

Boiler Fuel

Select the type of fuel used by the boiler.

Boiler Type

When configuring a Custom boiler, the Boiler Type offers six different options to choose from:

1-Stage

This setting operates a one-stage boiler and is available in all configurations. The Boiler Status displays 100% when the boiler is on and 0% when the boiler is off.

2-Stage

This setting operates a two-stage boiler and requires the next boiler output to be not configured. In addition, the 2-stages must be all on the same 294 or 294EXP and cannot span to another 294EXP.

Example: If boiler 1 is set to 2-stage, then boiler enable 1 and boiler enable 2 are used.

The Boiler Status displays 50% when stage 1 is on, 100% when stage 2 is on and 0% when the boiler is off.

3-Stage

This setting operates a three-stage boiler and requires the next two boiler outputs to be not configured. In addition, the 3-stages must be all on the same 294 or 294EXP and cannot span to another 294EXP.

Example: If boiler 1 is set to 3-stage, then boiler enable 1, 2 and 3 are used.

The Boiler Status displays 33% when stage 1 is on, 66% when stage 2 is on, 100% when stage 3 is on and 0% when the boiler is off.

4-Stage

This operates a four-stage boiler and requires the next three boiler outputs to be not configured. In addition, the 4-stages must be all on the same 294 or 294EXP and cannot span to another 294EXP.

Example: If boiler 1 is set to 4-stage, then boiler enables 1, 2, 3 and 4 are used.

The Boiler Status displays 25% when stage 1 is on, 50% when stage 2 is on, 75% when stage 3 is on, 100% when stage 4 is on, and 0% when the boiler is off.

Modulating Target Temp

The modulating output operates a boiler that interprets an analog input signal as a target temperature. The Output EMS Signal Minimum sets the starting voltage. The EMS Temperature Minimum sets the starting target temperature. The EMS Temperature Maximum sets the maximum target temperature.

The Boiler Status displays the boiler target temperature when the boiler is on and displays " - - " when the boiler is off.

Modulating Fire Rate

The modulating output operates a modulating boiler by controlling the burner firing rate. The Boiler Enable relay is also used to give a boiler enable to allow the modulating boiler to go through the ignition sequence. The boiler enable relay may not be necessary. Please consult the boiler manual to wiring information.

The Boiler Status displays the boiler firing rate when modulating the boiler from 0 to 100% output.

Modulation Type

Select the modulating output to be either 0-10 V (dc) or 4-20 mA. A 4-20 mA output can be converted to a 0 - 135 Ω output using a 0 - 135 Ω Converter 005.

Fire Delay

The Fire Delay is the ignition delay time of the boiler, from when the boiler enable contact is closed until when a flame is established. The Fire Delay can be found in the boiler manual or can be timed with a watch.

Modulation Delay

After the flame is established, some boilers require the firing rate to hold at low fire before the firing rate can change. Set this time as the Modulation Delay.

Boiler Mass

The Boiler Mass setting selects the thermal mass characteristics of each boiler. Operation of the boiler can become unstable if the incorrect Boiler Mass setting is chosen. A key sign of unstable boiler operation is that the flame will continue to increase and then decrease in short periods of time.

Low

Select Low mass for smaller sized boilers. This provides short pre and post purge times for the pumps, modulates the boiler firing rate at a slow rate, and operates the boiler staging with shorter inter-stage delays.

Medium

Select Medium mass for medium sized boilers. This provides moderate pre and post purge times for the pumps, modulates the boiler firing rate at a moderate rate, and operates the boiler staging with moderate inter-stage delays.

High

Select High mass for large commercial boilers. This provides long pre and post purge times for the pumps, modulates the boiler quickly, and operates the boiler staging with long inter-stage delays.

Very High

Select V.High mass for large commercial boilers that are overshooting with the high mass setting.

Boiler Low and High Output

In order to accommodate different boiler capacities in the same system, a low fire and high fire boiler output for each boiler is available. This allows the control to properly operate the boilers using either sequential or parallel modulation. Each boiler typically has a rating plate that specifies the minimum and maximum output. This information is also available in the boiler manual.

The minimum and maximum boiler output is entered in units of MBTU/hr. 1 MBTU / hr = 1,000 Btu per hour. The range is from 10 to 9990 MBTU/hr.

Modulation Motor Speed

The Modulation Motor Speed is the amount of time the analog modulating output signal to the boiler requires to go from 0% to 100% modulation.

Boilers with an electronic blower fan are recommended to use the factory default of 30 seconds.

Boilers with a modulating motor gas valve and linkage arms should set the Modulating Motor Speed to the time required to fully open the gas valve.

Start Modulation

The Start Modulation setting is the lowest modulation output required to obtain proper ignition.

Minimum Modulation

The Minimum Modulation is the lowest signal the control can send to modulate the boiler and operates the boiler at low fire.

- Refer to the boiler manufacturer's literature to determine the minimum output voltage V (dc) or current (mA) that the boiler will successfully operate at.

For 0 to 10 V (dc):

Minimum Modulation =

$$\frac{\text{Boiler's Minimum Input Signal}}{10 \text{ V (dc)}} \times 100\%$$

For 4 to 20 mA:

Minimum Modulation =

$$\frac{\text{Boiler's Minimum Input Signal} - 4\text{mA}}{16 \text{ mA}} \times 100\%$$

Example:

A boiler requires a 1.8 V (dc) signal to fire the boiler at low fire. The boiler can be modulated to 10 V (dc) where it reaches high fire.

$$\text{Minimum Modulation} = \frac{1.8 \text{ V}}{10 \text{ V}} \times 100\% = 18\%$$

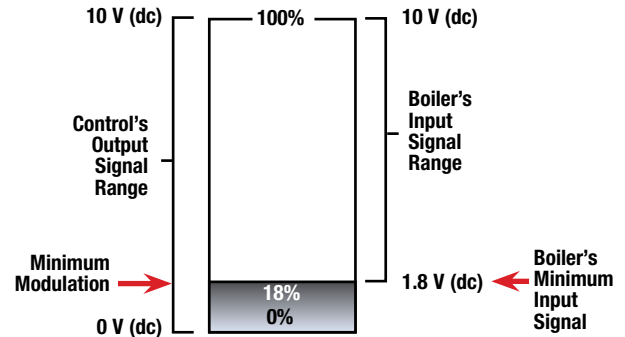

Maximum Modulation

The Maximum Modulation is the highest signal the control can send to modulate the boiler.

For 0 to 10 V (dc):

Maximum Modulation =

$$\frac{\text{Boiler's Maximum Input Signal}}{10 \text{ V (dc)}} \times 100\%$$

For 4 to 20 mA:

Maximum Modulation =

$$\frac{\text{Boiler's Maximum Input Signal} - 4\text{mA}}{16 \text{ mA}} \times 100\%$$

Example:

A boiler's input signal range is 0 to 9 V (dc). The 294 control has an output signal range of 0 to 10 V (dc).

$$\text{Maximum Modulation} = \frac{9 \text{ V}}{10 \text{ V}} \times 100\% = 90\%$$

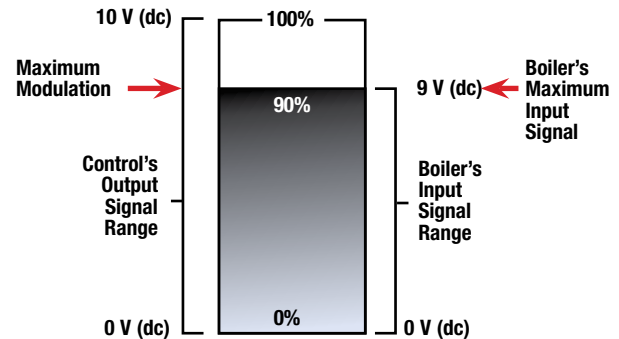

Boiler Group

The control has two boiler groups: 1) Condensing; and 2) Non-condensing. Select the boiler group based upon the construction of the boiler. In general, most boilers with cast-iron or copper-fin tube heat exchangers are non-condensing; while boilers with stainless steel and aluminum heat exchangers are condensing.

Post Purge

This setting sets the amount of time the control operates the boiler pump or valve after the boiler is turned off. This purges heat out of the boiler, reducing stand-by losses, and also reduces "kettling" on low mass boilers. The amount of time for the boiler pump post purge is adjustable between 0 to 20 minutes.

Boiler Modbus Communication

The control includes a modbus port to communicate to boilers. This allows the control to read the lockout and/or hold error codes from the boiler. These error codes are recorded in the notification menu, and if connected to the Internet, the notification is sent as an email, SMS text or push notification.

The supported boilers in firmware version 1.0.0 include:

MANUFACTURER	SERIES
Aerco	AM Series
Laars	OmniTherm
Laars	MagnaTherm
Laars	MagnaTherm FT
Laars	MagnaTherm HTD
Laars	Pennant
Laars	NeoTherm
Laars	NeoTherm LC
Lochinvar	Crest
Lochinvar	Crest Outdoor
Lochinvar	FTXL
Lochinvar	Knight Outdoor
Lochinvar	Knight XL
Lochinvar	PowerFin
Raypak	MVB
Raypak	XFIIRE
Raypak	Xtherm
Raypak	Xvers
Raypak	Xvers L

All trademarks, service marks and company names are the property of their respective owners

The 294 uses a boiler presets file that is periodically updated by tekmar. Please connect your 294 to receive the latest updates.

System Operation

The Smart Boiler Control 294 is able to operate up to four boilers and can be expanded up to a maximum of sixteen boilers through the use of Smart Boiler Expansion 294EXP.

Boiler Target Temperature

The boiler target temperature is determined by the type of call received. If there are multiple heat calls, the boiler target is adjusted to the highest call. If the control does not presently have a requirement for heat, “---” is displayed on the home screen.

Boiler Minimum

The Boiler Minimum is the lowest temperature that the control is allowed to use as a boiler target temperature. During mild conditions, if the control receives a call that is below the boiler minimum setting, the boiler target temperature is adjusted to the boiler minimum setting.

Notice:

The Boiler Minimum is only applied when at least one of the boilers is configured to part of the non-condensing boiler group. Set the Boiler Minimum setting to the boiler manufacturer's recommended temperature.

Boiler Maximum

The Boiler Maximum is the highest temperature that the control is allowed to use as a boiler target temperature. If a heat call is higher than the boiler maximum, the boiler maximum is adjusted down to the boiler maximum setting. Set the boiler maximum setting below the boiler operator or aquastat temperature.

Notice:

The boiler operator, or aquastat, remains in the burner circuit and acts as an upper limit on the boiler temperature. The boiler aquastat temperature setting must be adjusted above the 294's boiler maximum setting in order to prevent short cycling of the burner.

Staging Type

The control supports two staging operations:

- Proportional-Integral-Derivative (PID)
- Proportional

PID is recommended for central heating and combined central heating with domestic hot water applications. Proportional staging is recommended for volume domestic hot water heating and applications that require rapid response to heating loads.

PID Staging

PID staging makes use of the following parameters to determine when the next boiler is turned on:

- PID Boiler Differential
- PID Stage Delay

PID Boiler Differential

Both on/off and modulating boilers are operated with a differential. For modulating boilers, the differential no longer applies once operating the boiler above low fire.

The differential operates by turning on the boiler when the boiler supply water temperature is $\frac{1}{2}$ of the differential below the boiler target temperature. As the boiler supply water tem-

perature reaches $\frac{1}{2}$ of the differential above the boiler target temperature, the boiler is shut off.

Manual Differential

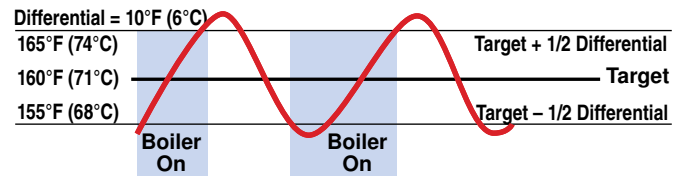

Automatic Differential

The automatic differential operation monitors previous boiler on and off cycles and automatically adjusts the differential to minimize boiler short cycling. In light load conditions the boiler differential is increased; while in high load conditions the boiler differential is decreased.

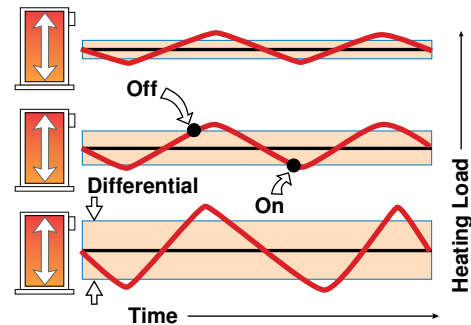

PID Stage Delay

The Stage Delay is the minimum time delay between the firing of each boiler or boiler stage. After this delay has expired the control can fire the next boiler or boiler stage if it is required. This setting can be adjusted manually or set to an automatic setting. When the automatic setting is used, the control determines the stage delay based on the boiler mass setting with low mass having a short delay and high mass having long delays.

Proportional Staging

Proportional staging makes use of the following parameters to determine when the next boiler is turned on. All conditions must be met to turn on the next available boiler.

- Interstage Differential
- Interstage On Delay
- Interstage Off Delay
- Minimum Stage Run Time
- Minimum Stage Off Time

Interstage Differential

Select the temperature drop from the prior boiler turning on to turn on the next boiler stage. The first boiler turns on when the boiler supply temperature drops the Interstage Differential below the boiler target. The next boiler must drop by twice the Interstage Differential to turn on the next boiler. The same pattern is repeated for all available boilers.

Interstage On Delay

When a boiler stage is turned on, the Interstage On Delay time must elapse before the next boiler is able to turn on.

Interstage Off Delay

When a boiler stage is shut off, the Interstage Off Delay time must elapse before the next boiler is available to turn on again.

Minimum Stage Run Time

When a boiler stage turns on, it must remain on for the duration of the minimum stage run time. This prevent boiler short cycling.

Minimum Stage Off Time

When a boiler stage turns off, it must remain off for the duration of the minimum stage off time. This prevents boiler short cycling.

Boiler Group Sequencing

The boilers are divided into two groups:

- Condensing Boiler Group
- Non-condensing Boiler Group

Each boiler group allows the selection of sequential or parallel sequencing. Boilers in the condensing group are always the first to fire followed by boilers in the non-condensing group.

Sequential Sequencing

With Sequential sequencing, the control will turn on the fewest boilers possible to meet the load. The control will bring a boiler up to 100% firing rate before bringing on an additional boiler at it's minimum firing rate. If operating multi-stage boilers, sequential staging always fires stages in the order of 1, 2, 3, and 4.

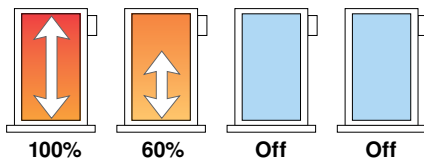

Parallel Sequencing

With Parallel sequencing, the control will turn on the most boilers at the minimum firing rate. The control turns on the first boiler at the minimum firing rate and does not increase its modulation. If more boiler output is required, additional boilers will turn on at the minimum firing rate until all available boilers are on. If still more boiler output is required, all boilers are modulated in parallel until they reach 100% firing rate. If operating multi-stage boilers, the control stages all of the low stage outputs in all of the boilers first. Once all of the boilers are operating on their low stages, the control then operates the second stage in each boiler in the same order. The same process is repeated for the third and fourth stages respectively.

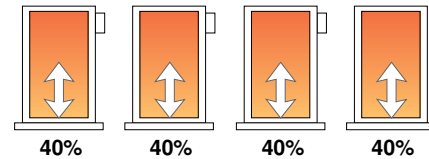

Condensing and Non-Condensing Boiler Groups

Operating a boiler plant that contains both condensing (high initial cost) and non-condensing (lower initial cost) boilers allows the boiler plant to achieve nearly the same operating efficiencies as operating all condensing boilers but at a much lower capital cost to the building owner. High system efficiency can be achieved as long as the condensing boilers are the first to operate in the firing sequence. During mild weather, the lead condensing boilers operate at lower boiler temperatures and achieve their peak boiler efficiencies while the non-condensing boilers are rarely operated. During very cold weather, the boiler target temperature is often above the boiler's condensation point and the condensing and non-condensing boilers operate together at roughly the same efficiency level.

When a condensing boiler is operating, it is desirable to operate the boilers without a boiler minimum temperature being applied to the boiler target. This allows the condensing boiler to operate at its maximum efficiency. When a non-condensing boiler is operating, a boiler minimum temperature should be applied to the boiler target to prevent damage to the non-condensing boiler's heat exchanger from sustained flue gas condensation.

The 294 supports operation of a condensing and a non-condensing boiler group. A condensing boiler group is created when at least one boiler is selected to be condensing and a non-condensing boiler group is created when at least one boiler is selected to be non-condensing. The condensing boiler group is always sequenced on first, followed by the non-condensing boiler group.

Boiler Group Rotation

The control has two boiler rotation groups:

- Condensing Boiler Rotation Group
- Non-condensing Boiler Rotation Group

The Rotate feature changes the firing order of the boilers whenever one boiler accumulates 48 hours more run time than any other boiler. Rotation will be forced if any boiler accumulates 60 hours more run time. After each rotation, the boiler with the least running hours is the first to fire and the boiler with the most running hours is the last to fire. This function ensures that all of the boilers receive equal amounts of use. When Rotation is Off, the firing sequence always begins with lowest boiler to the highest boiler.

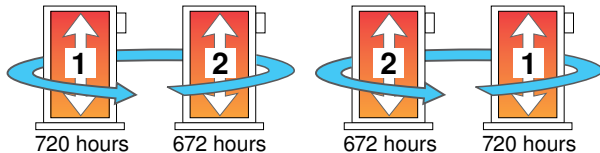

Boiler Run Time Monitoring

The running time of each boiler is logged in the Boiler Status screen. Select the boiler hours to view the Boiler Hours and select CLEAR to zero the running hours. This action also zero's the boiler for the boiler Equal Run Time sequence.

Fixed Lead

When the boiler plant includes only one boiler group, either a condensing or a non-condensing group, a selection must be made regarding operation of the lead boiler.

In some applications, it may be desirable to have the first boiler fire first at all times while the firing sequence of the remaining boilers is changed using Equal Run Time Rotation. This configuration is typical of installations where the boiler plant includes similar boilers but the first boiler is required to be the first to fire in order to establish sufficient draft for venting. With a fixed lead rotation, the lead boiler is always turned on first and turned off first. The Fixed Lead is always applied to the boiler 1 output.

Fixed Last

When the boiler plant includes only one boiler group, either a condensing or a non-condensing group, a selection must be made regarding operation of the last boiler.

In some applications, it may be desirable to have the last boiler fire last at all times while the firing sequence of the remaining boilers is changed using Equal Run Time Rotation. This configuration is typical of installations where the boiler plant includes higher efficient boilers and a single lesser efficient boiler. The lesser efficient boiler is only desired to be operated when all other boilers in the plant are on and the load cannot be satisfied. With a fixed last rotation, the last boiler is the last to turn on and the first to turn off. The Fixed Last is always applied to the last available boiler on the 294 or 294EXP (boiler 4, 8, 12, or 16).

Boiler Plant Flow

The control supports the option of having all boilers in the plant to use either a pump or an isolation valve.

Boiler Pump

Select Boiler Pump if each boiler has its own pump to provide flow in the near boiler piping. Boiler pump can be selected if the system is piped in reverse-return with a single system pump.

Boiler Isolation Valve

Select Isolation Valve when each boiler in the plant includes an isolation valve and a single or parallel system pumps that include a Variable Frequency Drive (VFD) to reduce speed to reduce electrical energy.

The purpose of the isolation valve is to isolate the boiler from plant operation when the boiler is turned off. As a boiler is isolated, the VFD will adjust the flow rate accordingly. The isolation valve must include a spring return motor that is of the normally open / fail open type. As the control does not include a proof input for proving that the isolation valve is fully open prior to burner ignition, the motor end switch, if available, should be wired into the burner's safety circuit.

Boiler isolation valve operation is dependent on whether the Heat Call is permanent or intermittent.

- Permanent Central Heat Call

As the heating load becomes satisfied and a boiler is required to be turned off, the boiler will turn off while its isolation valve remains open for the boiler purge period time. After the boiler purge time expires, the isolation valve will close. When the last boiler in the plant turns off, its isolation valve will remain open, allowing for a flow path of the primary pump.

When there is a subsequent requirement for plant operation and a boiler is required to be turned on, its isolation valve will be opened (if not already open) prior to burner ignition. Also, if applicable, the isolation valve of the last boiler turned off in the previous cycle will be turned off.

- Intermittent Central Heating Call (e.g. interlocked with space heating thermostat)

When the Central Heat Call is present, operation is consistent with the operation defined for a Permanent Heat Call.

When the external Heat Call is removed, the isolation valve of every boiler will be opened. When the external Central Heat Call is re-applied, the control will keep open the valve of the boiler that is due to be turned on first. The isolation valves of all other boilers will be closed.

Pressure Monitoring

The control has the capability to monitor system pressure from 0 to 150 psi (1034 kPa) when the Pressure Sensor 088 is installed.

Once installed set the Pressure Sensor to On. The control include a Low Pressure Alert and a High Pressure Alert notification to alert users of pressure related problems. The pressure alerts to do not prevent boiler staging operation.

Pump Operation

System Pump Operation

The control includes a system pump that can operate whenever there is a call for heat.

Central Heating Call

The system pump turns on together with the central heating call.

Domestic Hot Water Call

The system pump can operate in combination with the DHW pump. Please refer to the Domestic Hot Water Call Operation for details.

Setpoint Call

The system pump can operate together with the Constant Setpoint Call. This is selectable using the Constant Setpoint System Pump setting.

Remote Setpoint Call

The system pump operates whenever there is a remote setpoint call.

System Pump Purge

The system pump includes a post-purge after a heating call is removed. The system pump post-purge operates with the last boiler pump post purge.

Exercising

The control has the option to exercise all pumps and tekmarNet zones (zone valves and zone pumps) for 10 seconds every three days of inactivity to prevent seizure. This is selected by setting Exercising to On.

Combustion Air Damper Operation

Combustion Air Damper

The combustion air damper relay closes once a heat call is received and the control has determined that one or more boilers need to be turned on.

Combustion Air Delay

The control waits until the combustion air damper delay elapses before staging on any boilers.

Combustion Air Post Purge

There is a fixed 15 second post purge of the Combustion Air Damper relay after the last boiler has turned off, or the heat call is removed. If there is a call still present once the last boiler has turned off, the control may continue to keep the combustion air damper open if the control predicts that a boiler may fire. Otherwise, the combustion air damper will be closed once the 15 second post purge elapses.

Schedule

To provide greater energy savings, the control can operate on a programmable 7-day, 4-event schedule. The schedule is stored in memory and is not affected by loss of power to the control.

Time Clock

When connected to the Internet, the control automatically sets its time to the Eastern time zone by default. This can be changed to one of the applicable North American time zones. By default Daylight Savings Time is On. Select Daylight Savings Time to Off for regions that do not observe daylight savings time.

If the Internet is not available, the control includes a built-in time clock to allow the control to operate on a schedule. A battery-less backup allows the control to keep time for up to 4 hours without power. The time clock supports automatic adjustment for Daylight Saving Time (DST) once the day, month, and year are entered.

Troubleshooting

It is recommended to complete all wiring to ensure trouble free operation. Should an error occur, simply follow these steps:

1. **Find:** If a banner is on the screen, it is indicating a problem on the system.
2. **Identify:** Press the ☰ icon on the top right corner to enter the menus and press notifications. The latest error notification will appear at the top of the list.
3. **Solve:** The notification description provides the instructions on the corrective action require to clear the error.

Errors and Alerts (1 of 4)

Error Title	Description
Control Memory Error	A memory error has been detected. The control will not operate the boilers until all settings have been reviewed. You may also reload factory defaults and use the Setup Wizard to configure the control. If the memory error keeps recurring after a power outage, the control may require replacement. Consult technical support for assistance.
Boiler Sensor Short Error	A short circuit is detected on the boiler supply temperature sensor input. The control will not operate the boilers until this fault is corrected. To correct, remove the wires from the boiler supply sensor terminals, then use an electrical multimeter to measure the resistance. The resistance should be proportional to the temperature lookup table in the Installation and Operation Manual. Check the wires for damage. If the wires are OK, then replace the Universal Sensor 082. Once the fault is corrected, the error clears automatically.
Boiler Sensor Open Error	An open circuit is detected on the boiler supply temperature sensor input. The control will not operate the boilers until this fault is corrected. To correct, remove the wires from the boiler supply sensor terminals, then use an electrical multimeter to measure the resistance. The resistance should be proportional to the temperature lookup table in the Installation and Operation Manual. If the resistance is open circuit, check the wires for loose wiring connections. If the wires are OK, then replace the Universal Sensor 082. Once the fault is corrected, the error clears automatically.
Domestic Hot Water Short Sensor Error	A short circuit is detected on the domestic hot water temperature sensor input. The control will not heat the domestic hot water tank until this fault is corrected. To correct, remove the wires from the DHW sensor terminals, then use an electrical multimeter to measure the resistance. The resistance should be proportional to the temperature lookup table in the Installation and Operation Manual. If the resistance is short circuit, check the wires for damage. If the wires are OK, then replace the Universal Sensor 078. Once the fault is corrected, the error clears automatically.
Domestic Hot Water Open Sensor Error	An open circuit is detected on the domestic hot water temperature sensor input. The control will not heat the domestic hot water tank until this fault is corrected. The DHW sensor is optional and the setting incorrectly turned on. Check if a sensor is installed. If not installed, set DHW Sensor to off. If installed, remove the wires from the DHW sensor terminals, then use an electrical multimeter to measure the resistance. The resistance should be proportional to the temperature lookup table in the Installation and Operation Manual. If the resistance is open circuit, check the wires for loose wiring connections. If the wires are OK, then replace the Universal Sensor 078. Once the fault is corrected, the error clears automatically.
Outdoor Sensor Short Error	A short circuit is detected on the outdoor air temperature sensor input. The control operates the central heating system at the boiler design temperature until this fault is corrected. To correct, remove the wires from the outdoor air sensor terminals, then use an electrical multimeter to measure the resistance. The resistance should be proportional to the temperature lookup table in the Installation and Operation Manual. If the resistance is short circuit, check the wires for damage. If the wires are OK, then replace the Outdoor Sensor 070. Once the fault is corrected, the error clears automatically.
Outdoor Sensor Open Error	An open circuit is detected on the outdoor air temperature sensor input. The control operates the central heating system at the boiler design temperature until this fault is corrected. To correct, remove the wires from the outdoor air sensor terminals, then use an electrical multimeter to measure the resistance. The resistance should be proportional to the temperature lookup table in the Installation and Operation Manual. If the resistance is open circuit, check the wires for loose wiring connections. If the wires are OK, then replace the Outdoor Sensor 070. Once the fault is corrected, the error clears automatically.

Errors and Alerts (2 of 4)

Error Title	Description
tekmarNet Outdoor Sensor Error	The control has not received an outdoor temperature report from the tekmarNet network. Check the tekmarNet network for the location of the outdoor sensor measurement. Check the sensor for open or short circuits and replace the Outdoor Sensor 070 if necessary. Once the fault is corrected, the error clears automatically.
Internet Outdoor Sensor Error	The control has not received an outdoor temperature report from the Internet. Please check that your Router is not blocking Port 443. Please contact an IT professional if assistance is required.
Pressure Sensor Open Circuit Error	An open circuit is detected on the pressure sensor input. The control continues to operate normally but is unable to detect pressure changes. If a pressure sensor is not installed, set the Pressure Sensor setting in the System menu to Off. If a pressure sensor is installed, inspect the wires for loose connections. If the wires are OK, use an electrical meter to measure the DC voltage between the pressure sensor Ref and Gnd terminals. This should measure 5.0 V(dc). Then check the voltage between pressure sensor In and Gnd. This voltage should measure 0.5 to 4.5 V(dc) depending on the system pressure. If either voltage reading is abnormal then replace the Pressure Sensor 088. Once the fault is corrected, the error clears automatically.
Pressure Sensor Short Circuit Error	A short circuit is detected on the pressure sensor input. The control continues to operate normally but is unable to detect pressure changes. Inspect the pressure sensor wires for damage. If the wires are OK, use an electrical meter to measure the DC voltage between the pressure sensor Ref and Gnd terminals. This should measure 5.0 V(dc). Then check the voltage between pressure sensor In and Gnd. This voltage should measure 0.5 to 4.5 V(dc) depending on the system pressure. If either voltage reading is abnormal then replace the Pressure Sensor 088. Once the fault is corrected, the error clears automatically.
Expansion Communication Error	The control has lost communication to all Smart Boiler Expansion. Boilers 5 through 16 will not operate until this error is corrected. To correct, check the expansion communication wires +, -, and Gnd on both the control and expansion to ensure the wire polarity is correct, the wire insulation is stripped, and the wire terminals are tight.
Expansion 5 to 8 Lost Error	The control has lost communication to the Smart Boiler Expansion operating boilers 5 to 8. Boilers 5 through 8 will not operate until this error is corrected. To correct, check that the expansion power light is on. If the power light is off, use an electrical multimeter to check the power line and neutral terminals for 115 V(ac). If the expansion power light is on, then check the expansion communication wires +, -, and Gnd on both the control and expansion to ensure the wire polarity is correct, the wire insulation is stripped, and the wire terminals are tight.
Expansion 9 to 12 Lost Error	The control has lost communication to the Smart Boiler Expansion operating boilers 9 to 12. Boilers 9 through 12 will not operate until this error is corrected. To correct, check that the expansion power light is on. If the power light is off, use an electrical multimeter to check the power line and neutral terminals for 115 V(ac). If the expansion power light is on, then check the expansion communication wires +, -, and Gnd on both the control and expansion to ensure the wire polarity is correct, the wire insulation is stripped, and the wire terminals are tight.
Expansion 13 to 16 Lost Error	The control has lost communication to the Smart Boiler Expansion operating boilers 13 to 16. Boilers 13 through 16 will not operate until this error is corrected. To correct, check that the expansion power light is on. If the power light is off, use an electrical multimeter to check the power line and neutral terminals for 115 V(ac). If the expansion power light is on, then check the expansion communication wires +, -, and Gnd on both the control and expansion to ensure the wire polarity is correct, the wire insulation is stripped, and the wire terminals are tight.
tN4 Bus Error	Communication has been lost on the Boiler Bus. Check the tN4, C and R wires for each tN4 device. Check the polarity of the C and R wires. Check for loose or broken wires. The error message self clears once the error condition is corrected.
tN4 Device b:01 to b:24 Lost Error	Communication is lost to tekmarNet device with address b:##. The ## varies from 01 to 24. To correct, ensure that there is power to the lost device. Trace the wires from the control to the lost device looking for loose or damaged wires. The error message self clears when the error condition is corrected. If the tN4 device is deliberately removed, go to the Reset menu and press tekmarNet Device Reset.
tN4 Duplicate Master Error	More than one tN4 system control has been detected on the tN4 Boiler Bus. The 294 is a "Master Device" and no other tekmarNet boiler control can be added to the tN4 Boiler Bus terminals. To correct, remove all other tekmarNet boiler controls from the tN4 Bus.

Error Messages (3 of 4)

Error Title	Description
tN4 Device b:01 to b:25 Error	A tN4 thermostat or device with address b:## has an error that requires corrective action. The ## varies from 01 to 25. Locate the tN4 device and troubleshoot using the device's Installation and Operating Manual.
Ethernet Disconnected Error	The Ethernet is not connected to a network. Check the Ethernet cable connection to the control and the Router or Switch. Check that the Router or Switch is powered on and operating correctly.
Wi-Fi Disconnected Error	The Wi-Fi network could not be found. Please check that the Wi-Fi network name was entered correctly and that the Router signal is medium to high strength. If necessary, please reconfigure your Wi-Fi network.
Wi-Fi Invalid Password Error	The Wi-Fi Password was not accepted. Please check that the password was entered correctly. If necessary, please reconfigure your Wi-Fi network.
DHCP Address Error	The router has not assigned the control an IP address. Please check the router's configuration settings and ensure that the DHCP server is enabled and enough IP addresses are available. Please contact an IT professional for assistance.
Internet Unavailable Error	The control is unable to communicate to the Watts cloud through the Internet. The error will automatically clear once Internet communications are established. You may also set the Internet Connection Type to Off to clear the error. To correct: 1. Check the control's Internet DNS 1 and DNS 2 settings 2. Check that the router firewall is not blocking or filtering MAC addresses 3. Check that the router firewall is not blocking outbound port 23
Watts® OnSite Error	The control is unable to connect to Watts OnSite. Please check that your router is not blocking outbound ports 443 or 8883. Please contact an IT professional for assistance.
Boiler Plant No Heat Alert	The boiler supply temperature did not increase within the boiler alert time. There is likely a mechanical failure with either a boiler or circulator that requires immediate attention. The control operates normally while this alert is present. To reset the alert, press the 'X' button to dismiss the error message on the home screen.
Boiler High Temperature Alert	The boiler supply temperature exceeded the boiler high temperature alert threshold. There is likely a mechanical failure with either a boiler or circulator that requires immediate attention. The control operates normally while this alert is present. The alert clears when the boiler supply temperature falls 2°F (1°C) below the boiler high temperature alert threshold.
Boiler Low Temperature Alert	The boiler supply temperature fell below the boiler low temperature alert threshold. There is likely a mechanical failure with either a boiler or circulator that requires immediate attention. The control operates normally while this alert is present. The alert clears when the boiler supply temperature rises 2°F (1°C) above the boiler low temperature alert threshold.
High Pressure Alert	The system pressure exceeded the high pressure alert threshold. There may be a problem with the system expansion tank or makeup water feed. The control operates normally while this alert is present. The alert clears when the pressure falls 1 psi (7 kPa) below the high pressure alert threshold.
Low Pressure Alert	The system pressure exceeded the low pressure alert threshold. There may be a leak in the system. The control operates normally while this alert is present. The alert clears when the pressure rises 1 psi (7 kPa) above the low pressure alert threshold.
Boiler 01 to 16 Error	The control has read an error code status from boiler 01 to 16 through the modbus communication channel. To correct the issue, please lookup the error code in the boiler manufacturer's manual. Manufacturer: List of select boiler manufacturers Series: List of select supported boiler series Model: List of select supported boiler models Code: Modbus error code from boiler

Error Messages (4 of 4)

Error Title	Description
Modbus Bus Error	The control has detected a problem with the boiler modbus communication. Check the modbus wire polarity, the cable length, connection to the boiler, and connection of any terminating resistors.
Modbus Boiler 01 to 16 Lost Error	The control is unable to communicate to Boiler 01 to 16 through Modbus. Please check that the boiler manufacturer, make and model are set correctly. Please contact tekmar technical support for further assistance.
Boiler 01 to 16 Service Hours Alert	The boiler run time has exceeded the recommended boiler service hours alert interval. Once maintenance has been completed, the service interval can be reset in the boiler status screen.
Boiler 01 to 16 Service Cycles Alert	The boiler has exceeded the recommended boiler service cycles. Once maintenance has been completed, the service interval can be reset in the boiler status screen.
Unsupported tN4 Device	An unsupported tN4 device is connected to tekmarNet communication network. This may include the Mixing Expansion Modules 440, 441, and 444. The error will clear automatically one this device is removed.
Hardware Fault	An internal hardware fault has been detected. Please power the control off then back on. If the hardware fault reoccurs, the control may require replacement. Please contact technical support for assistance.

Technical Data

Smart Boiler Control 294	
Literature	Submittal, Application, Installation and Operating Manual, Job Record, Watts OnSite Manual
Packaged weight	3.3 lb. (1500 g)
Dimensions	9" H x 8" W x 2 ¹¹ / ₁₆ " D (229 x 203 x 60 mm)
Display	5" color touchscreen
Enclosure	Blue ABS plastic, NEMA type 1
Approvals	CSA C US, meets FCC Part 15B, ICES-003 Class A
Ambient conditions	Indoor use only, 32 to 122°F (0 to 50°C), < 90% RH non-condensing, Altitude < 6560 feet (2000 m), Installation Category II, Pollution Degree 2
Power supply	115 V (ac) ±10%, 60 Hz, 9 W
Relays	230 V (ac), 5 A, 1/3 hp
Modulating outputs	0-10 V (dc) 500 Ω minimum load impedance or 4-20 mA 1 kΩ max load impedance
Calls	24 V (ac) or Short
Sensors	NTC thermistor, 10 kΩ @ 77°F (25°C ±0.2°C) β=3892
-Included	Outdoor Sensor 070, Universal Sensor 082
-Optional	tekmar type: 071, 078, 087, 088
Communications	10/100 Ethernet, WiFi 802.11n, 2.4 GHz, WPA2 encryption
Mobile App	Apple* iOS 14 or higher, Android** 10 or higher
Warranty	Limited 3 Year

* Apple and App Store are trademarks of Apple Inc.

** Google, Android and Google Play are trademarks of Google LLC.

Limited Warranty and Product Return Procedure

Limited Warranty *The liability of tekmar under this warranty is limited. The Purchaser, by taking receipt of any tekmar product ("Product"), acknowledges the terms of the Limited Warranty in effect at the time of such Product sale & acknowledges that it has read & understands same.*

The tekmar Limited Warranty to the Purchaser on the Products sold hereunder is a manufacturer's pass-through warranty which the Purchaser is authorized to pass through to its customers. Under the Limited Warranty, each tekmar Product is warranted against defects in workmanship & materials if the Product is installed & used in compliance with tekmar's instructions, ordinary wear & tear excepted. The pass-through warranty period is for a period of twenty-four (24) months from the production date if the Product is not installed during that period, or twelve (12) months from the documented date of installation if installed within twenty-four (24) months from the production date.

The liability of tekmar under the Limited Warranty shall be limited to, at tekmar's sole discretion: the cost of parts & labor provided by tekmar to repair defects in materials &/or workmanship of the defective product; or to the exchange of the defective product for a warranty replacement product; or to the granting of credit limited to the original cost of the defective product, & such repair, exchange or credit shall be the sole remedy available from tekmar, &, without limiting the foregoing in any way, tekmar is not responsible, in contract, tort or strict product liability, for any other losses, costs, expenses, inconveniences, or damages, whether direct, indirect, special, secondary, incidental or consequential, arising from ownership or use of the product, or from defects in workmanship or materials, including any liability for fundamental breach of contract.

The pass-through Limited Warranty applies only to those defective Products returned to tekmar during the warranty period. This Limited Warranty does not cover the cost of the parts or labor to remove or transport the defective Product, or to reinstall the repaired or replacement Product, all such costs & expenses being subject to Purchaser's agreement & warranty with its customers.

Any representations or warranties about the Products made by Purchaser to its customers which are different from or in excess of the tekmar Limited Warranty are the Purchaser's sole responsibility & obligation. Purchaser shall indemnify & hold tekmar harmless from & against any & all claims, liabilities & damages of any kind or nature which arise out of or are related to any such representations or warranties by Purchaser to its customers.

The pass-through Limited Warranty does not apply if the returned Product has been damaged by negligence by persons other than tekmar, accident, fire, Act of God, abuse or misuse; or has been damaged by modifications, alterations or attachments made subsequent to purchase which have not been authorized by tekmar; or if the Product was not installed in compliance with tekmar's instructions &/or the local codes & ordinances; or if due to defective installation of the Product; or if the Product was not used in compliance with tekmar's instructions.

THIS WARRANTY IS IN LIEU OF ALL OTHER WARRANTIES, EXPRESS OR IMPLIED, WHICH THE GOVERNING LAW ALLOWS PARTIES TO CONTRACTUALLY EXCLUDE, INCLUDING, WITHOUT LIMITATION, IMPLIED WARRANTIES OF MERCHANTABILITY & FITNESS FOR A PARTICULAR PURPOSE, DURABILITY OR DESCRIPTION OF THE PRODUCT, ITS NON-INFRINGEMENT OF ANY RELEVANT PATENTS OR TRADEMARKS, & ITS COMPLIANCE WITH OR NON-VIOLATION OF ANY APPLICABLE ENVIRONMENTAL, HEALTH OR SAFETY LEGISLATION; THE TERM OF ANY OTHER WARRANTY NOT HEREBY CONTRACTUALLY EXCLUDED IS LIMITED SUCH THAT IT SHALL NOT EXTEND BEYOND TWENTY-FOUR (24) MONTHS FROM THE PRODUCTION DATE, TO THE EXTENT THAT SUCH LIMITATION IS ALLOWED BY THE GOVERNING LAW.

Product Warranty Return Procedure All Products that are believed to have defects in workmanship or materials must be returned, together with a written description of the defect, to the tekmar Representative assigned to the territory in which such Product is located. If tekmar receives an inquiry from someone other than a tekmar Representative, including an inquiry from Purchaser (if not a tekmar Representative) or Purchaser's customers, regarding a potential warranty claim, tekmar's sole obligation shall be to provide the address & other contact information regarding the appropriate Representative.



A WATTS Brand

All specifications are subject to change without notice

Tel: 1-800-438-3903 • Fax: (250) 984-0815
tekmarControls.com