

SANDWICH OVER SUBFLOOR

Watts Radiant

Radiant Floors & Snowmelting

Ph: 417/864.6108

Fax: 417/864.8161

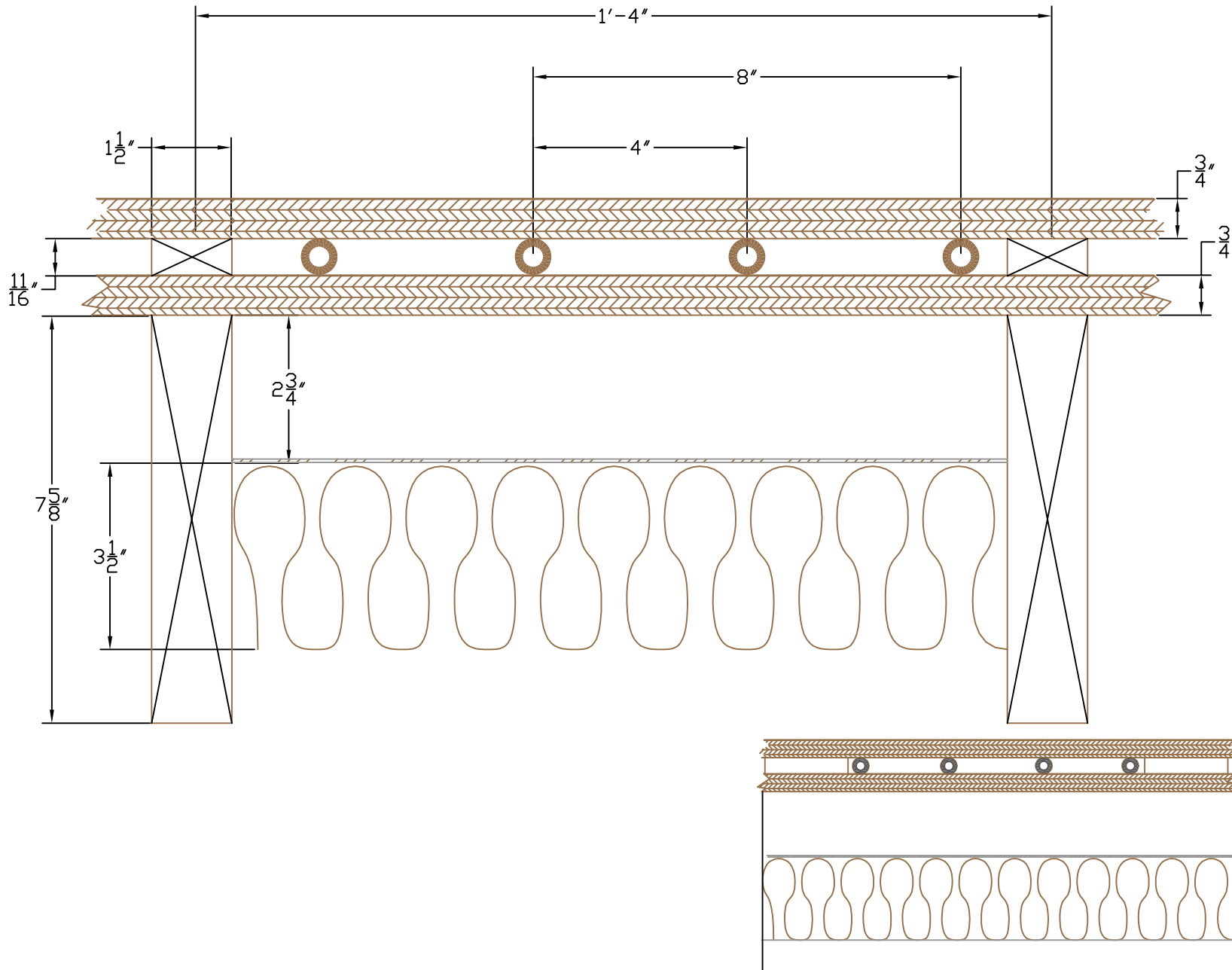







GENERAL NOTES:

Cross sections are intended to illustrate typical radiant installations. Floor construction details shown are to be used for illustrative purposes only, not for actual construction. Structural details will need to be determined by the project engineer, architect or other.

SPECIFIER INFORMATION:

ONIX CROSS SECTIONAL DETAILS:

General Legend

-  Concrete (Thin Slab)/ Mud
-  Joist/Sleepers
-  Plywood
-  Sand Fill
-  Board/Batt Insulation
-  Gravel Bed/Earth Fill

SANDWICH OVER SUBFLOOR

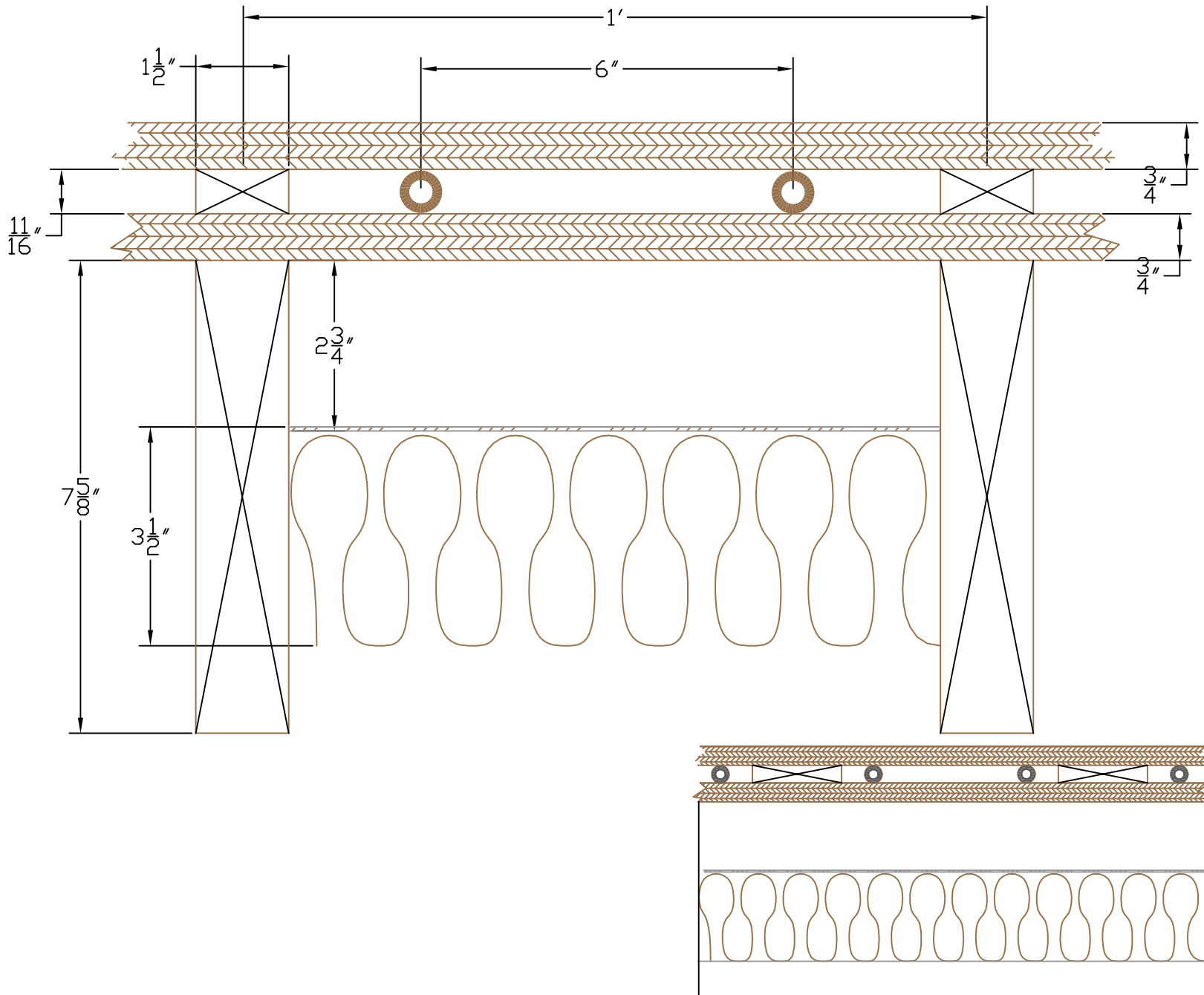

Watts Radiant

Radiant Floors & Snowmelting

Ph: 417/864.6108

Fax: 417/864.8161







GENERAL NOTES:

Cross sections are intended to illustrate typical radiant installations. Floor construction details shown are to be used for illustrative purposes only, not for actual construction. Structural details will need to be determined by the project engineer, architect or other.

SPECIFIER INFORMATION:

ONIX CROSS SECTIONAL DETAILS:

General Legend

-  Concrete (Thin Slab)/ Mud
-  Joist/Sleepers
-  Plywood
-  Sand Fill
-  Board/Batt Insulation
-  Gravel Bed/Earth Fill

SANDWICH OVER SUBFLOOR

Watts Radiant

Radiant Floors & Snowmelting

Ph: 417/864.6108

Fax: 417/864.8161







GENERAL NOTES:

Cross sections are intended to illustrate typical radiant installations. Floor construction details shown are to be used for illustrative purposes only, not for actual construction. Structural details will need to be determined by the project engineer, architect or other.

SPECIFIER INFORMATION:

ONIX CROSS SECTIONAL DETAILS:

General Legend

-  Concrete (Thin Slab)/ Mud
-  Joist/Sleepers
-  Plywood
-  Sand Fill
-  Board/Batt Insulation
-  Gravel Bed/ Earth Fill

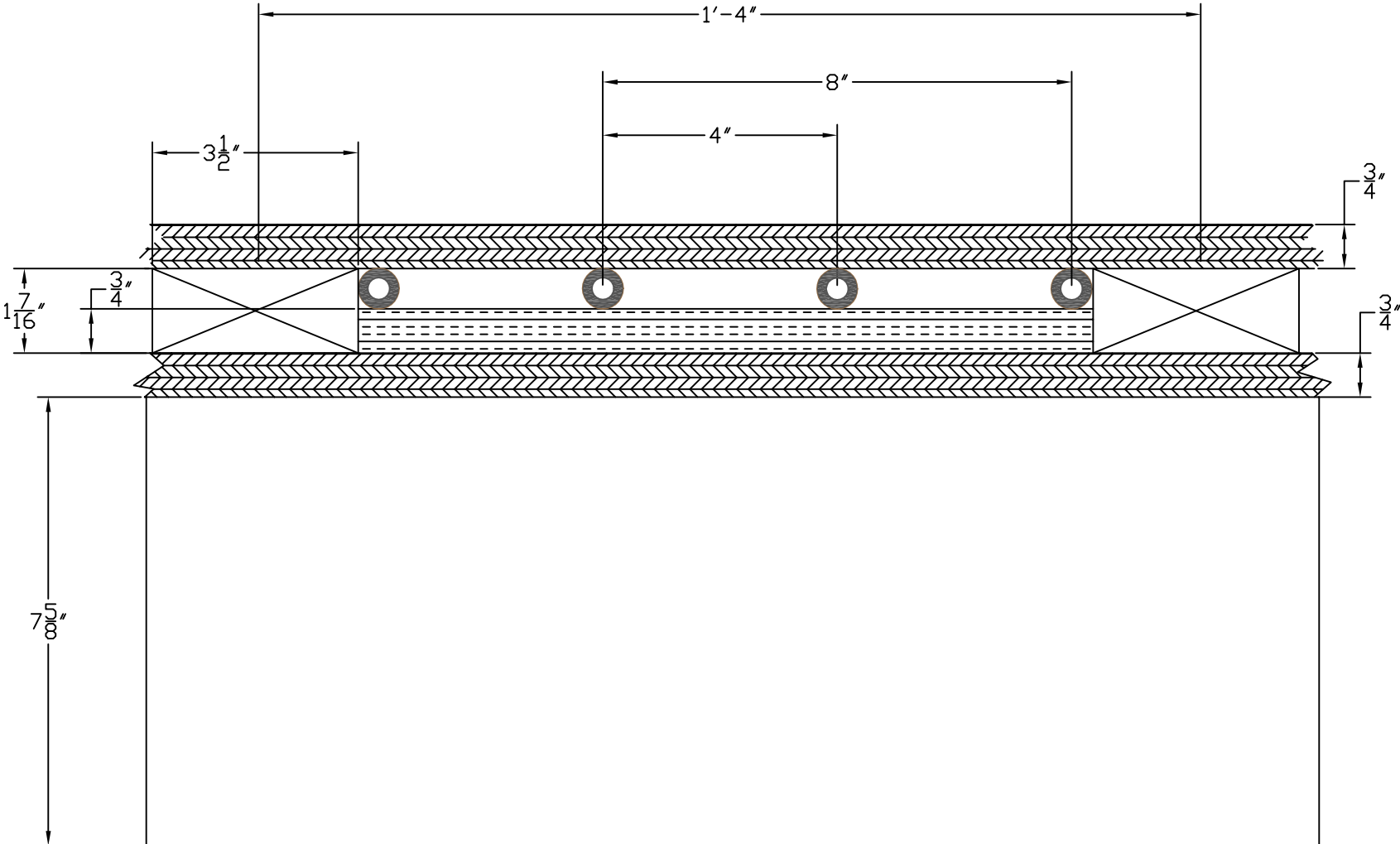

SANDWICH OVER SUBFLOOR

Watts Radiant

Radiant Floors & Snowmelting

Ph: 417/864.6108

Fax: 417/864.8161







GENERAL NOTES:

Cross sections are intended to illustrate typical radiant installations. Floor construction details shown are to be used for illustrative purposes only, not for actual construction. Structural details will need to be determined by the project engineer, architect or other.

SPECIFIER INFORMATION:

ONIX CROSS SECTIONAL DETAILS:

General Legend

-  Concrete (Thin Slab)/ Mud
-  Joist/Sleepers
-  Plywood
-  Sand Fill
-  Board/Batt Insulation
-  Gravel Bed/Earth Fill

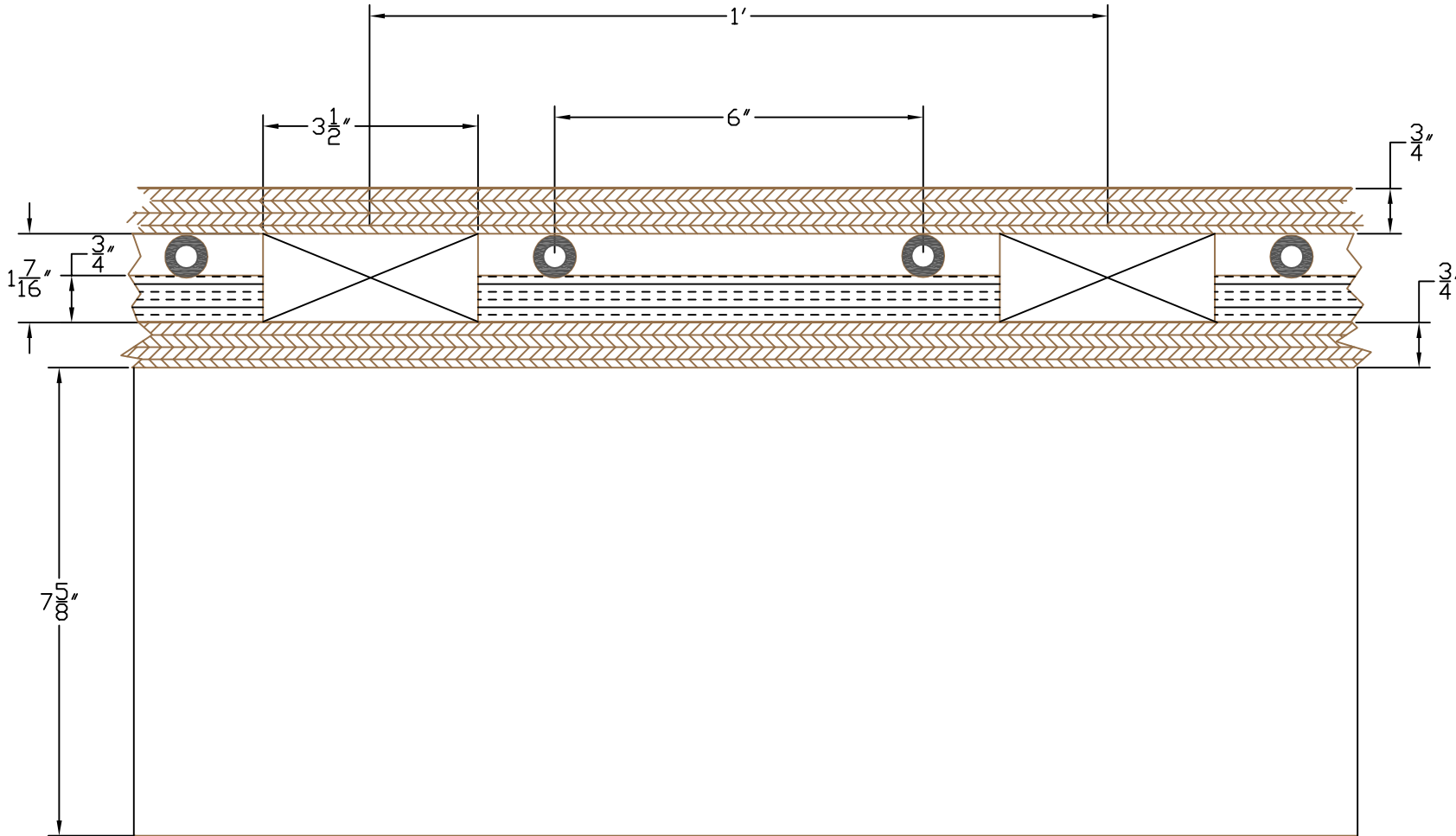

SANDWICH OVER SUBFLOOR - CONC. FILL

Watts Radiant

Radiant Floors & Snowmelting

Ph: 417/864.6108

Fax: 417/864.8161







GENERAL NOTES:

Cross sections are intended to illustrate typical radiant installations. Floor construction details shown are to be used for illustrative purposes only, not for actual construction. Structural details will need to be determined by the project engineer, architect or other.

SPECIFIER INFORMATION:

ONIX CROSS SECTIONAL DETAILS:

General Legend

-  Concrete (Thin Slab)/ Mud
-  Joist/Sleepers
-  Plywood
-  Sand Fill
-  Board/Batt Insulation
-  Gravel Bed/ Earth Fill

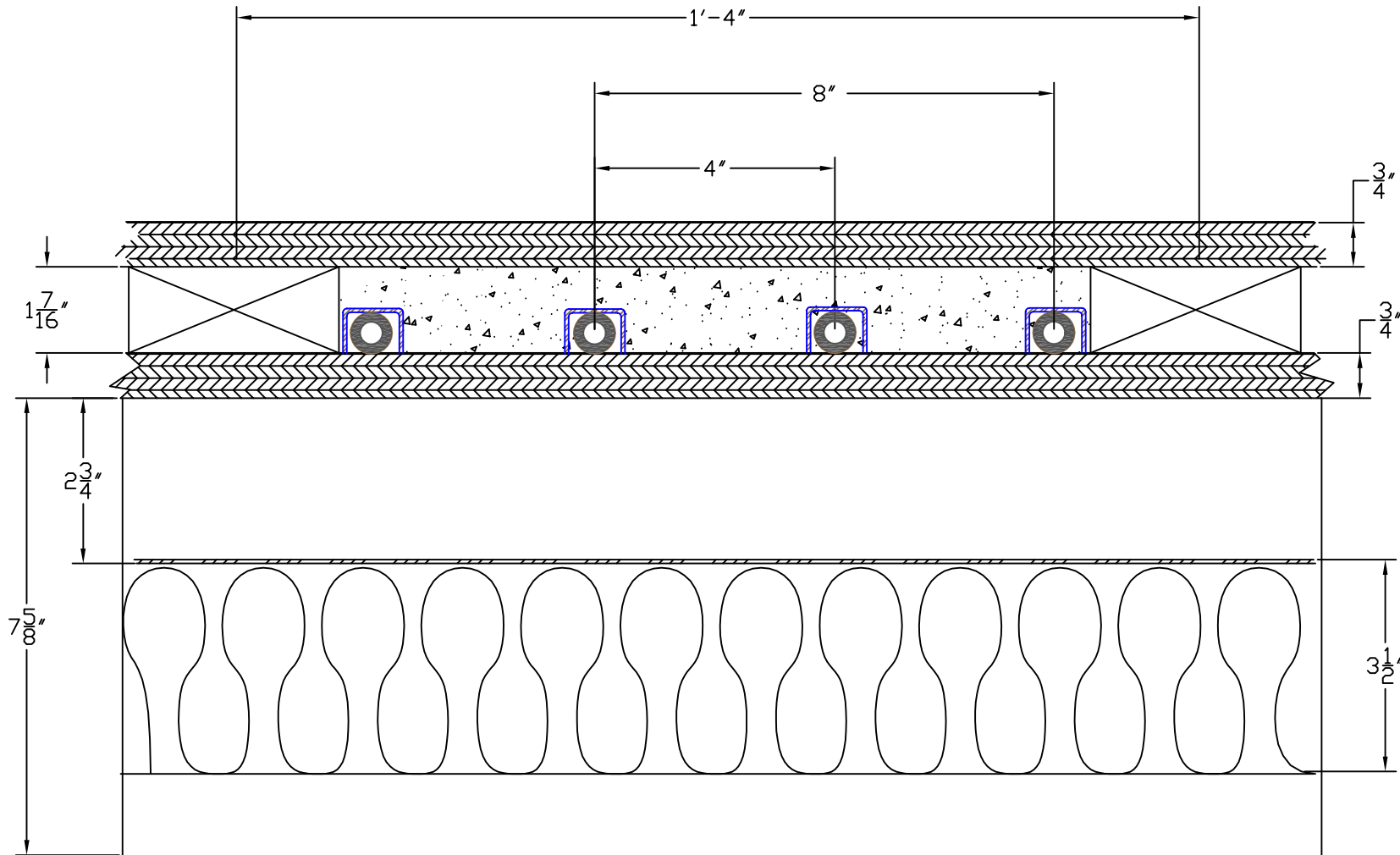

SANDWICH OVER SUBFLOOR - CONC. FILL

Watts Radiant

Radiant Floors & Snowmelting

Ph: 417/864.6108

Fax: 417/864.8161







GENERAL NOTES:

Cross sections are intended to illustrate typical radiant installations. Floor construction details shown are to be used for illustrative purposes only, not for actual construction. Structural details will need to be determined by the project engineer, architect or other.

SPECIFIER INFORMATION:

ONIX CROSS SECTIONAL DETAILS:

General Legend

-  Concrete (Thin Slab)/ Mud
-  Joist/Sleepers
-  Plywood
-  Sand Fill
-  Board/Batt Insulation
-  Gravel Bed/Earth Fill

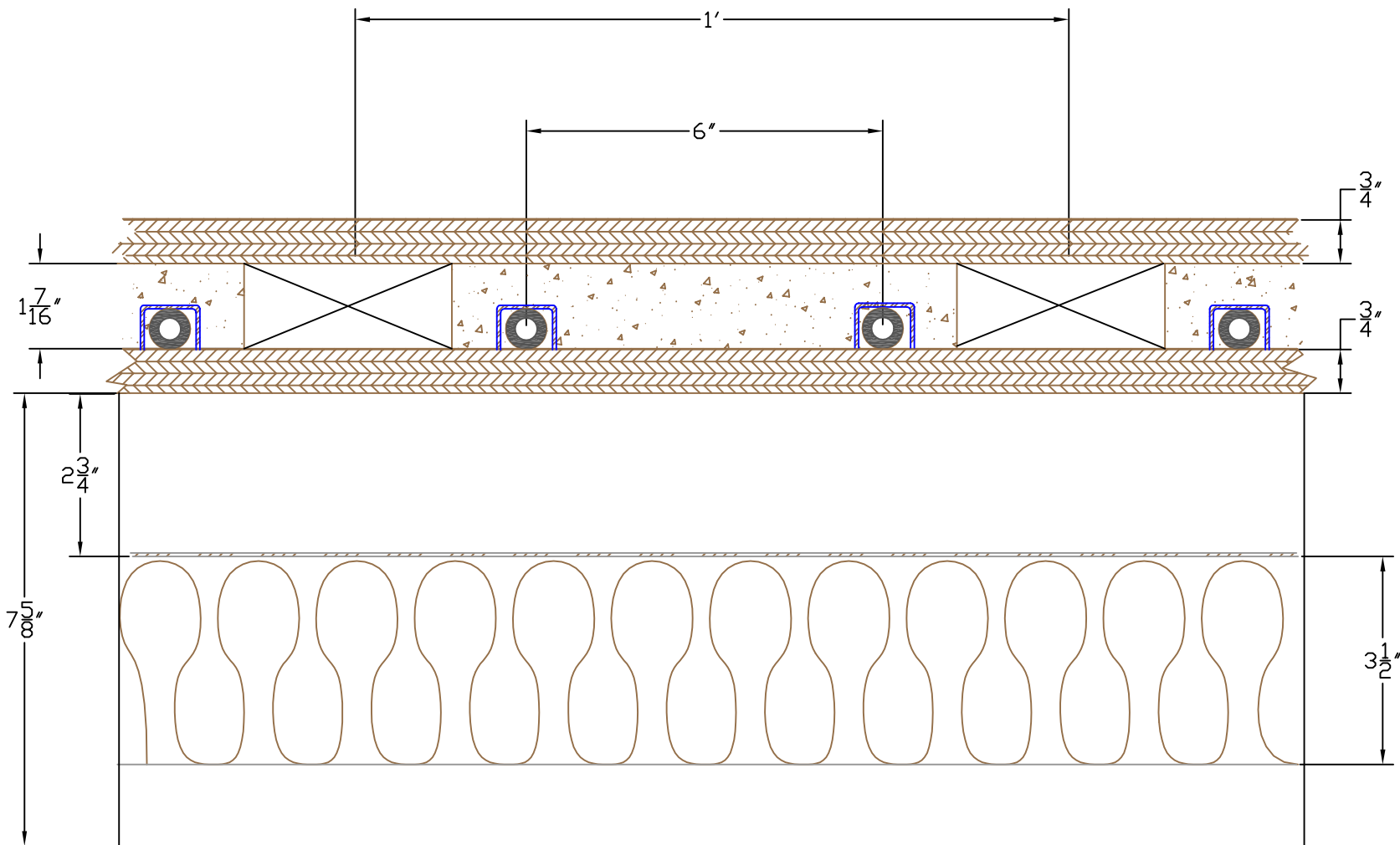

SANDWICH OVER SUBFLOOR - SAND FILL

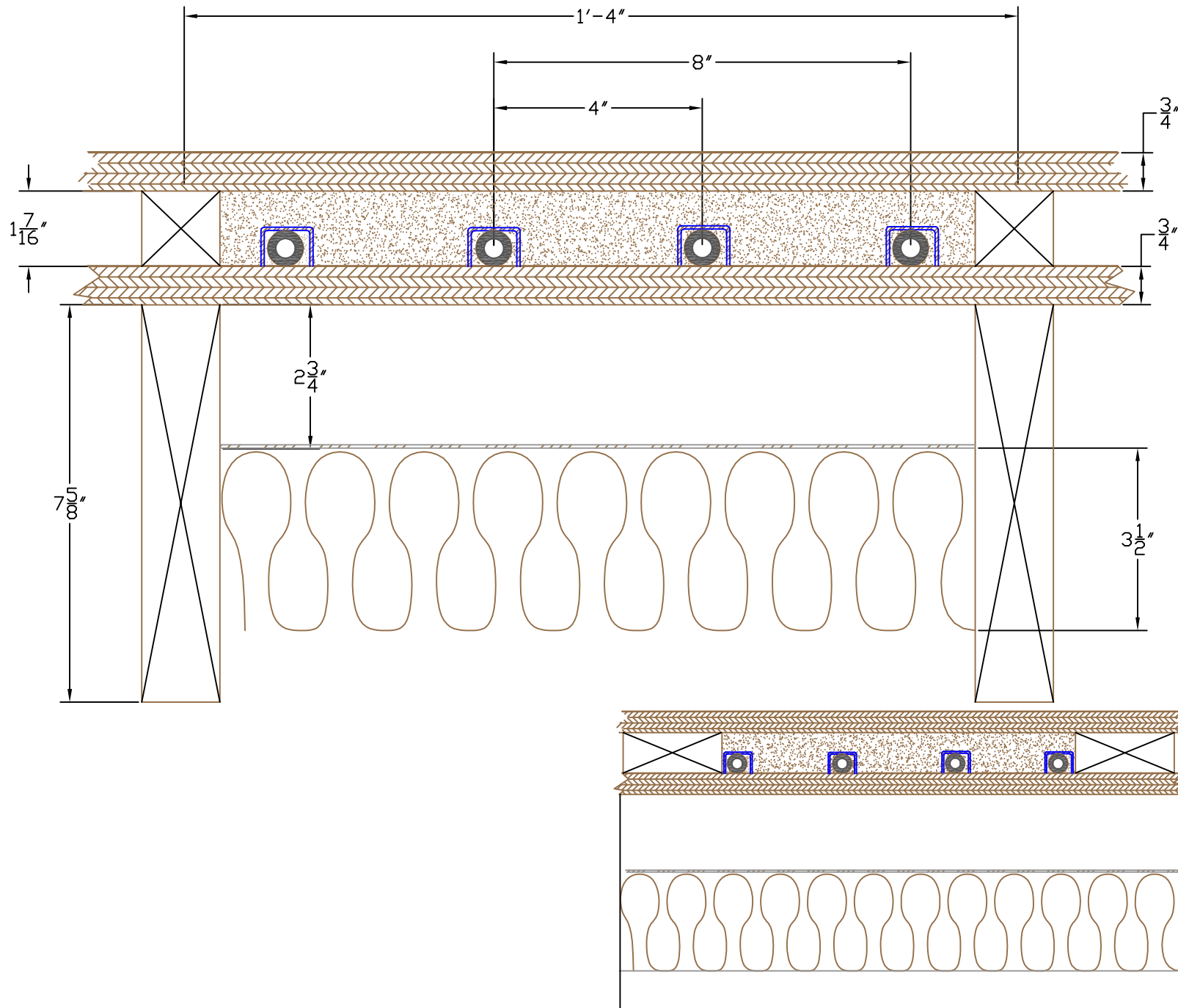

Watts Radiant

Radiant Floors & Snowmelting

Ph: 417/864.6108

Fax: 417/864.8161







GENERAL NOTES:

Cross sections are intended to illustrate typical radiant installations. Floor construction details shown are to be used for illustrative purposes only, not for actual construction. Structural details will need to be determined by the project engineer, architect or other.

SPECIFIER INFORMATION:

ONIX CROSS SECTIONAL DETAILS:

General Legend

-  Concrete (Thin Slab)/ Mud
-  Joist/Sleepers
-  Plywood
-  Sand Fill
-  Board/Batt Insulation
-  Gravel Bed/Earth Fill

SANDWICH OVER SUBFLOOR - SAND FILL

Watts Radiant

Radiant Floors & Snowmelting

Ph: 417/864.6108

Fax: 417/864.8161

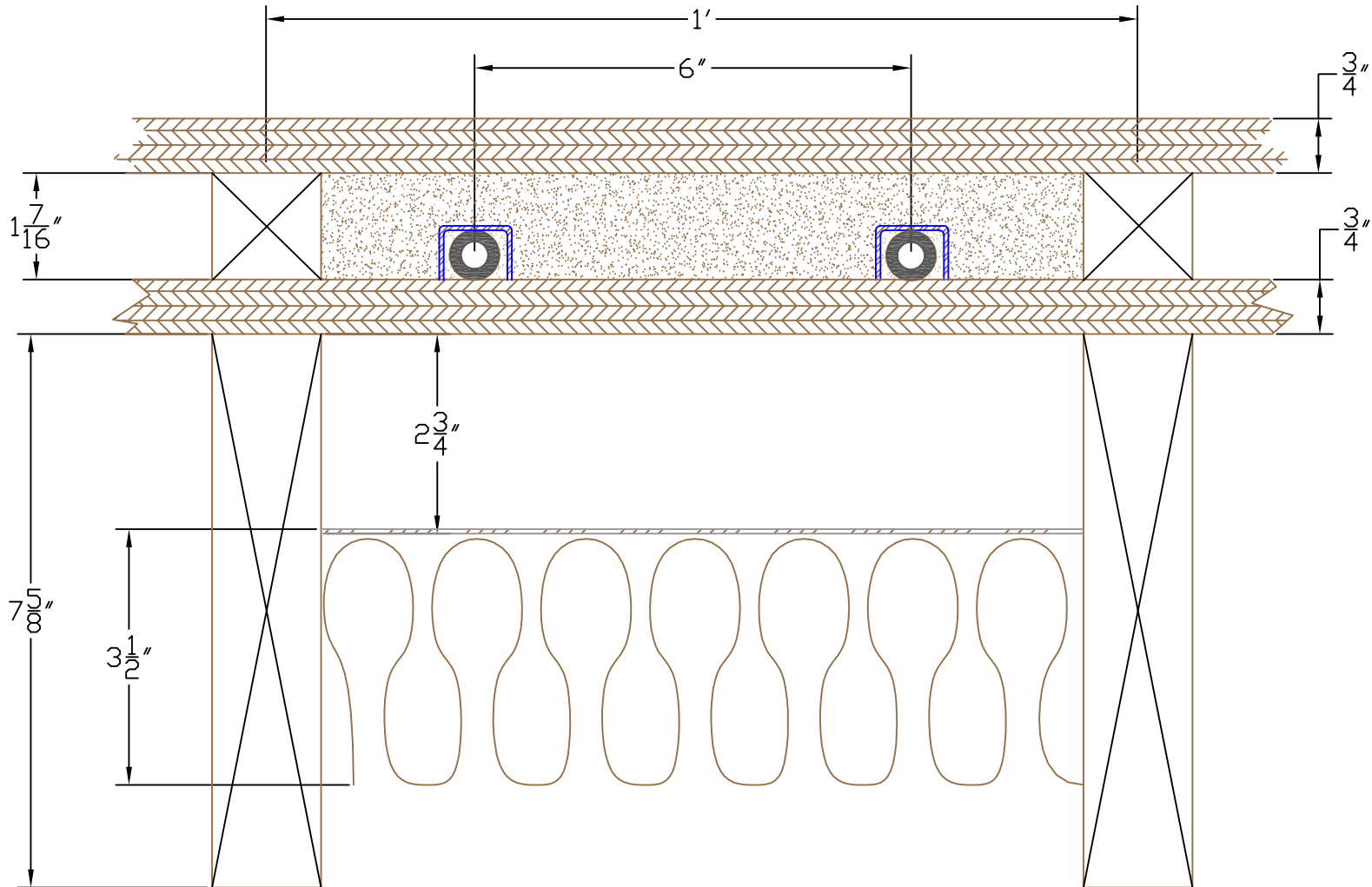







GENERAL NOTES:

Cross sections are intended to illustrate typical radiant installations. Floor construction details shown are to be used for illustrative purposes only, not for actual construction. Structural details will need to be determined by the project engineer, architect or other.

SPECIFIER INFORMATION:

ONIX CROSS SECTIONAL DETAILS:

General Legend

-  Concrete (Thin Slab)/ Mud
-  Joist/Sleepers
-  Plywood
-  Sand Fill
-  Board/Batt Insulation
-  Gravel Bed/Earth Fill

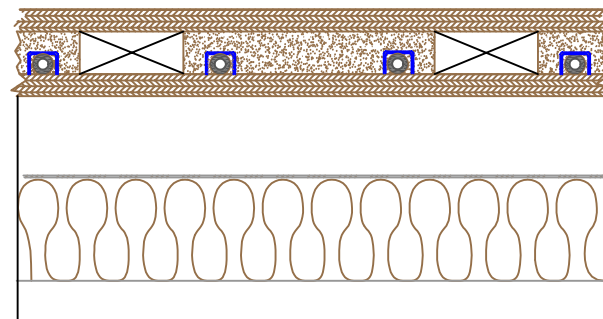

SANDWICH OVER SLAB

Watts Radiant

Radiant Floors & Snowmelting

Ph: 417/864.6108

Fax: 417/864.8161







GENERAL NOTES:

Cross sections are intended to illustrate typical radiant installations. Floor construction details shown are to be used for illustrative purposes only, not for actual construction. Structural details will need to be determined by the project engineer, architect or other.

SPECIFIER INFORMATION:

ONIX CROSS SECTIONAL DETAILS:

General Legend

-  Concrete (Thin Slab)/ Mud
-  Joist/Sleepers
-  Plywood
-  Sand Fill
-  Board/Batt Insulation
-  Gravel Bed/Earth Fill

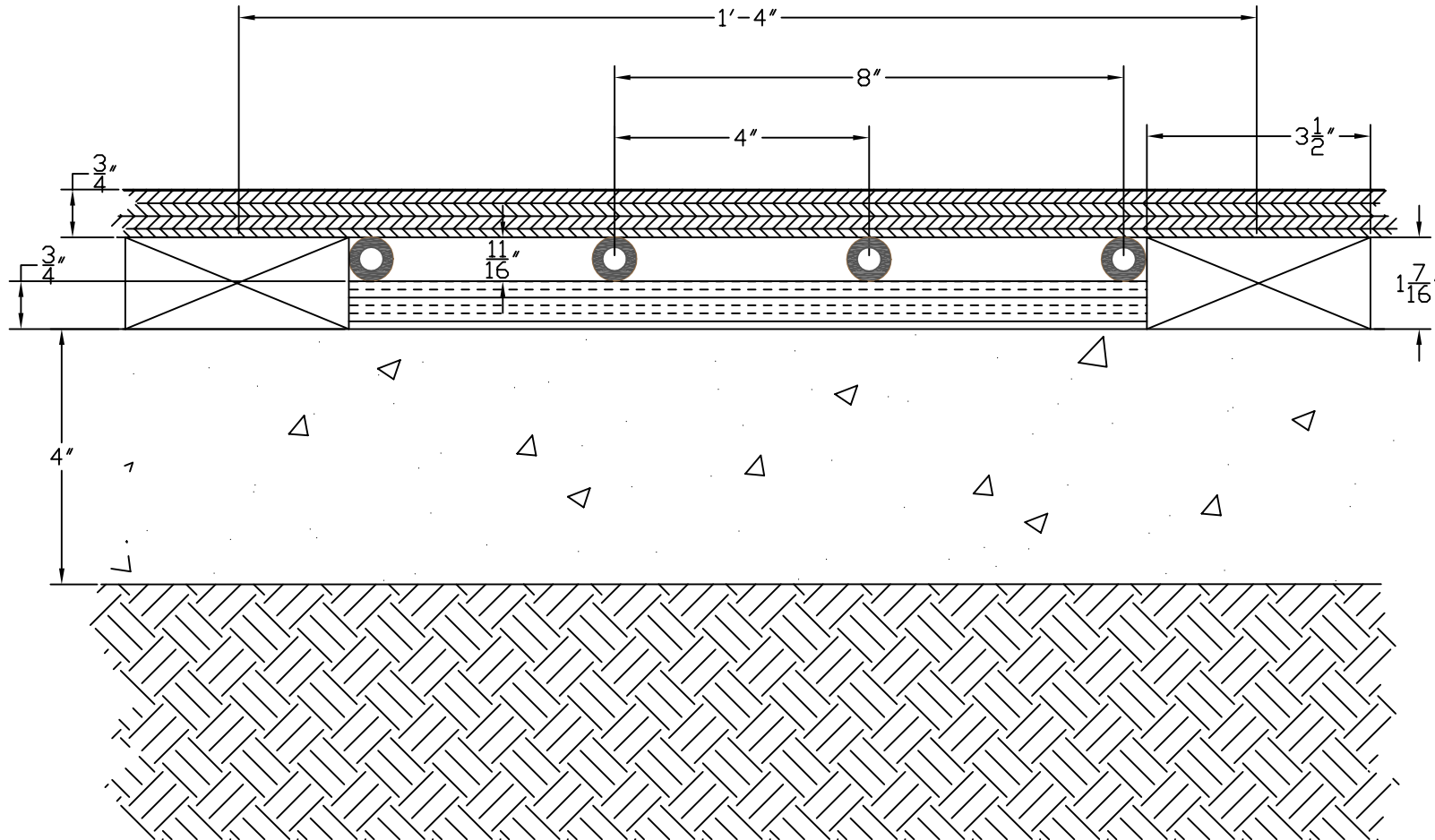

SANDWICH OVER SLAB

Watts Radiant

Radiant Floors & Snowmelting

Ph: 417/864.6108

Fax: 417/864.8161

GENERAL NOTES:





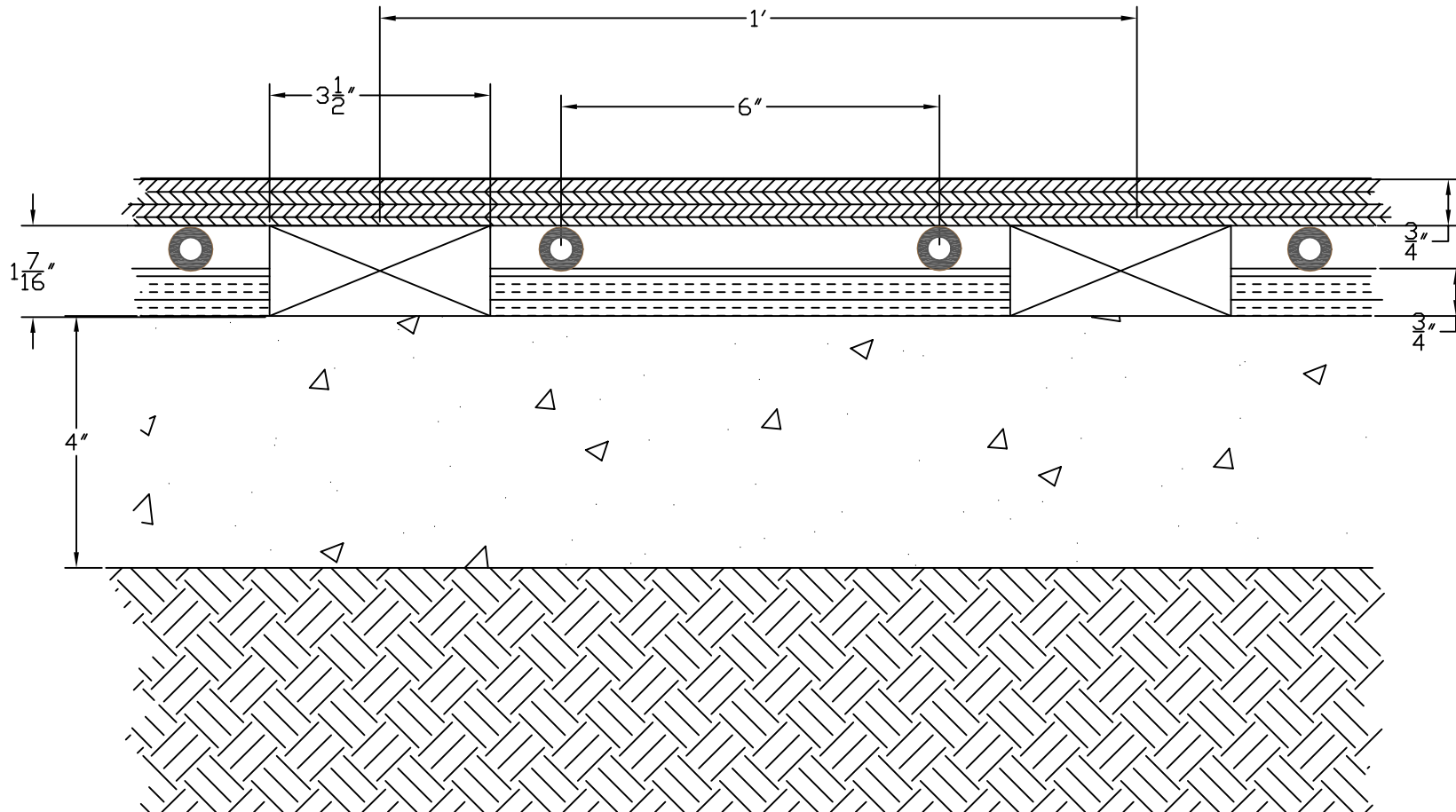

Cross sections are intended to illustrate typical radiant installations. Floor construction details shown are to be used for illustrative purposes only, not for actual construction. Structural details will need to be determined by the project engineer, architect or other.

SPECIFIER INFORMATION:



ONIX CROSS SECTIONAL DETAILS:

General Legend

-  Concrete (Thin Slab)/ Mud
-  Joist/Sleepers
-  Plywood
-  Sand Fill
-  Board/Batt Insulation
-  Gravel Bed/Earth Fill