

Installation & Operation Manual

Snow/Ice Sensor 090 *In slab, w 65 ft cable* Snow/Ice Sensor Socket 091

Introduction

The Snow/Ice Sensor 090 is an in ground sensor used with Watts Radiant snow melting controls 653 and 654, and some tekmar snow melting controls to automatically detect snow or ice on a driveway or walkway. The snow/ice sensor has 65 ft (20 m) of wire. This product can be used in applications ranging from residential driveways to commercial building fronts such as emergency access entries. This sensor allows the above

snow melting controls to automatically operate the snow/ice melt system only when snow or ice is present, while also providing slab temperature feedback to the control.

The Snow/Ice Sensor Socket 091 is designed to provide a mounting solution for the Snow/Ice Sensor 090. It is intended to be installed directly into a concrete slab when the slab is poured, so that the 090 can be installed into it once dry.

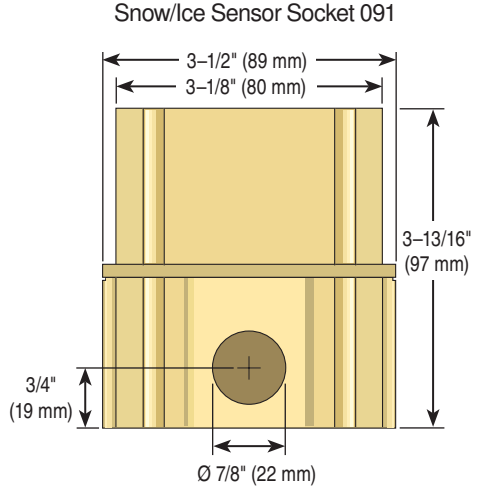
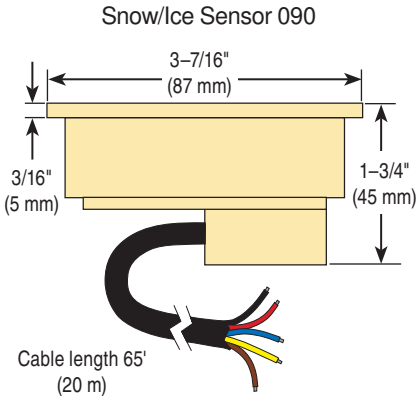

Snow/Ice Sensor 090 Features

- Automatic snow/ice detection
- Slab temperature sensing
- Long wire included so in field splicing is not necessary
- Designed for long life in driveway and walkway installations
- 65 ft (20 m) of cable

Snow/Ice Sensor Socket 091 Features

- Provides mounting solution for Snow/Ice Sensor 090
- Includes mounting plate

WattsRadiant™

WARNING

It is your responsibility to ensure that this sensor is safely installed according to all applicable codes and standards. Watts Radiant is not responsible for damages resulting from improper installation and/or maintenance.



Read this Manual BEFORE using this equipment.

Failure to read and follow all safety and use information can result in personal injury, property damage, or damage to the equipment.

Keep this Manual for future reference.

Step 1 - Check the Contents

Check the contents of this package. If any of the contents listed are missing or damaged, please refer to the Limited Warranty and Product Return Procedure on the back of this brochure and contact your wholesaler or Watts Radiant sales representative for assistance.

Order number 81005661 includes: • One Snow/Ice Sensor 090 with "O" ring • Four, #6-32 x 3/8" screws • Four, #4-40 x 7/16" screws • One Installation & Operation Manual

Order number 81003753 includes: • One Snow/Ice Sensor Socket 091 • One protective plastic plug • One plastic mounting plate • Eight, #6-32 x 3/8" screws • One Installation & Operation Manual

Step 2 - Sensor Installation

Location of the Sensor

- The location of the snow/ice sensor determines how well the snow melt detector responds to conditions on the snow melting slab. The sensor measures the temperature of the slab surface, and would normally be installed in a location that is representative of the average surface temperature and moisture conditions. The only exception to this practice would be those applications where the sensor is placed in a specific problem area where ice or snow often forms first.
- The installer should be careful to place the sensor in a location where it will not be affected by abnormal temperature conditions that may occur near buildings, hot air exhaust ducts or other heat sources, or sunny areas within a larger slab area.
- As well as reading temperatures, the sensor also detects surface water. The installer should be careful not to place the sensor where standing water could accumulate on its surface. Standing water in the socket may cause the snow melt system to be held on far longer than necessary, as the control will be getting a signal that water is present even though the rest of the slab surface may be dry. In addition, the sensor should not be placed in areas where drainage is considerably better than the surrounding area.
- The snow/ice sensor should not be installed in locations where vehicles park, near building overhangs or near trees since this may interfere with snow fall accumulation. If in doubt about the location of these obstacles, a second spare socket and conduit can be installed in order to provide a backup sensor location. Some Watts Radiant Snow Melting Controls are capable of dual sensing. To determine if this feature is available, refer to the Installation & Operation Manual for the Snow Melting Control.

- Vehicle tire and pedestrian traffic can track water and contaminants onto the snow melt area. If the snow/ice sensor is located in the traffic area, snow melting will be triggered by the passing traffic. This may be desirable in commercial areas where excessive traffic can cause the surface to become icy. In residential installations, the amount of traffic is usually limited, and it may be desirable to locate the snow/ice sensor away from the traffic area. This will reduce the number of snow melt events that occur and thereby reduce the annual fuel consumption.
- Locate the sensor midway between the heating pipes or elements.

Conduit

Place the sensor socket at the chosen location and run a conduit for the cable from the socket to the snow melting control. If more than 65' (20m) of cable is required to reach the control, run the conduit to a weatherproof junction box. The sensor cable should be run in its own conduit and not in combination with high voltage wiring.

The conduit length from the sensor to the junction box should be less than the 65' (20m) of cable supplied with the snow/ice sensor.

At the junction box, additional 18 AWG, 5 conductor cable can be spliced on to increase the total length to 500' (150m) from the sensor to control.

Avoid tying the conduit to the rebar within 6' (2m) of the socket. This allows the rebar grid to move without disturbing the position of the socket.

Sloped Surfaces

The top of the snow/ice sensor should be flush and parallel to that of the snow melt surface.

When the sensor is installed on a sloped driveway, the sensor must be installed near the lowest elevation of the slope. This is required since the melting snow or ice runoff water will drain toward the lowest point on the driveway and keep this area wet for longer periods of time.

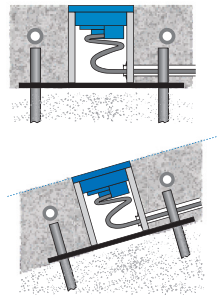

Installing the Socket

A mounting plate has been included to simplify the installation of the sensor socket. When possible, the mounting plate should be located directly on top of gravel in order to provide good drainage. If the slab is more than 4" thick, a mound of crushed rock or a styrofoam or wooden block can be used to elevate the socket. A hole must be punched or drilled in the styrofoam or wooden block in order to provide drainage.

Failure to provide adequate drainage under the socket may reduce the life expectancy of the snow/ice sensor.

The mounting plate can be fastened to the ground by driving 1/2" (12.7 mm) rebar through the four holes located on each of the four corners and then tying the mounting plate to the rebar.

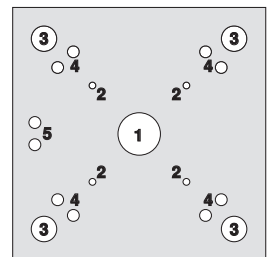

Mounting Plate

1. Drainage hole
2. Socket screw holes
3. Rebar holes
4. Rebar tie holes
5. Conduit tie holes

1. Cut four pieces of rebar at least 12" (300 mm) long.
2. Drive the rebar into the ground through each of the mounting plate rebar holes. Leave approximately 2" (50 mm) of rebar above the ground.
3. Cut several 12" (300 mm) pieces of steel wire.
4. Form a "U" shape and pull wire through the rebar tie hole from the bottom to the top side.
5. Repeat by pulling the "U" shape from the top to the bottom side.
6. Repeat (4) and (5) for each of the four corners.
7. Cross the wire, then wrap around the rebar.
8. Twist wire using pliers to tighten.

The mounting plate also has conduit tie holes to allow a cable tie or steel wire to fasten the conduit to the mounting plate.

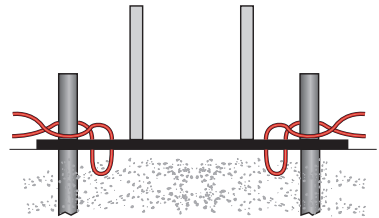
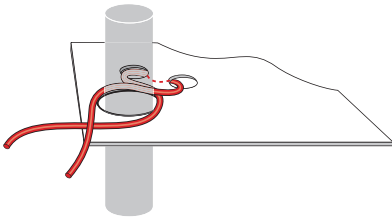

Placing Concrete

A plastic plug is provided with the socket to prevent it from being accidentally filled with concrete. The plastic plug is the same thickness as the sensor flange. This allows the finished surface of the concrete (asphalt, etc.) to be troweled flush with the plug. The plug must be installed prior to placing the concrete. Also ensure that the mounting plate drainage hole remains unplugged once the concrete has cured.

Installing Brick Pavers

If using brick pavers instead of concrete, it is recommended to mortar surrounding brick pavers to the side of the socket. This ensures good thermal conduction from the brick pavers to the socket. The top of the brick pavers should be level with the socket when the plastic plug is installed.

Install the Sensor and Cable

When the snow melt surface is finished, remove the plastic plug from the socket and fish the cable through the conduit until there is only 6 to 12" (150 to 300 mm) of cable between the sensor and conduit. Loop this remaining extra wire in a loose coil so as to not twist it, and place it, and the sensor into the socket. Secure the sensor to the socket with the four screws provided, making sure the "O" ring is in place and properly seated.

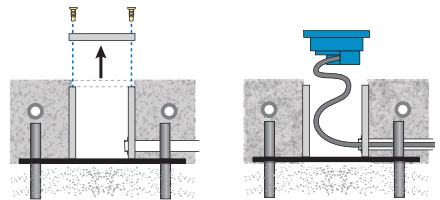

Placement in Existing 091 Socket

Current versions of the Snow/Ice Socket 091 use #6-32 screws. Previous versions of the 091 used smaller #4-40 screws. When replacing an 090, both sets of screws are provided. It is recommended to try the smaller screws first to avoid cross threading.

Salt and Brine Contamination

The performance of the snow/ice sensor water detection can be compromised when exposed to de-icing agents such as road salt, magnesium chloride, or calcium chloride. These contaminants can permanently damage the sensor. It is recommended to locate the sensor away from areas exposed to these deicing agents when at all possible. Locations to avoid could include tire track areas or areas close to a curb where traveling vehicles may splash contaminated water on to the sensor.

Maintenance

The Snow/Ice Sensor is installed in a harsh environment. Accumulation of dirt, salty grime, etc., on its surface will inhibit proper water detection. It should be checked on a regular basis and, when necessary, cleaned. Before cleaning, the control power should be shut off to prevent the control from entering the snow melt mode. Next, use a soft bristle brush and warm soapy water to clean the sensor surface. Do not use a steel wire brush as this will damage the sensor. Use a paper towel to thoroughly dry the sensor surface. After cleaning, re-power the control.

NOTICE

The Snow / Ice Sensor 090 must be operated by a Watts Radiant Snow Melting Control 653 or 654, or a compatible tekmar Snow Melting Control. Operation of the sensor by other control systems may result in electrolysis failures not covered by the sensor warranty.

Step 3 - Electrical Connections

The snow/ice sensor cable has 5 wires: Red, Black, Blue, Yellow, and Brown. The wires connect to the respective Red, Black, Blue, Yellow and Brown terminals on the Snow Melting Control.

Snow Melting Control 653 or 654

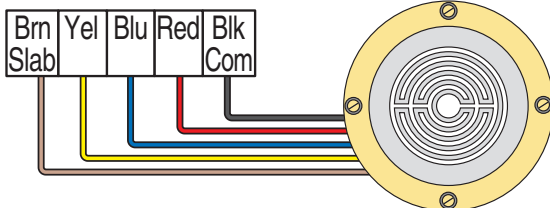

Step 4 - Test the Sensor

When performing these tests:

- The sensor head should be installed in the slab.
- The five cable wires at the control should be disconnected.
- Use a good quality electrical testing meter with an ohm scale range of 0 to 2,000,000 Ohms.

The sensor has two 10k Ohm thermistors. One reads slab surface temperature, and the other checks sensor heater temperature.

If the sensor has been disconnected from the control for an hour or more, the readings for both thermistors should be very close.

Using the ohmmeter and standard testing practices, measure the resistance between:

- (a) the yellow and black sensor wires (sensor temperature), and
- (b) the brown and black sensor wires (slab temperature).

The table below lists the expected resistance values at various sensor temperatures. Measure the resistance between the blue and black wires. When the sensor surface is dry, the reading should be 2,000,000 Ohms. When the sensor surface is wet it should be between 10,000 and 300,000 Ohms.

Measure the resistance between the red and black wires of the heating element. This reading should be close to 50 Ohms.

Temperature vs. Resistance Table

| Temperature | | Resistance | Temperature | | Resistance |
|-------------|-----|------------|-------------|----|------------|
| °F | °C | Ω | °F | °C | Ω |
| -50 | -46 | 490,813 | 30 | -1 | 34,558 |
| -45 | -43 | 405,710 | 35 | 2 | 29,996 |
| -40 | -40 | 336,606 | 40 | 4 | 26,099 |
| -35 | -37 | 280,279 | 45 | 7 | 22,763 |
| -30 | -34 | 234,196 | 50 | 10 | 19,900 |
| -25 | -32 | 196,358 | 55 | 13 | 17,436 |
| -20 | -29 | 165,180 | 60 | 16 | 15,311 |
| -15 | -26 | 139,402 | 65 | 18 | 13,474 |
| -10 | -23 | 118,018 | 70 | 21 | 11,883 |
| -5 | -21 | 100,221 | 75 | 24 | 10,501 |
| 0 | -18 | 85,362 | 80 | 27 | 9,299 |
| 5 | -15 | 72,918 | 85 | 29 | 8,250 |
| 10 | -12 | 62,465 | 90 | 32 | 7,334 |
| 15 | -9 | 53,658 | 95 | 35 | 6,532 |
| 20 | -7 | 46,218 | 100 | 38 | 5,828 |
| 25 | -4 | 39,913 | 105 | 41 | 5,210 |

Technical Data

| Snow/Ice Sensor 090 <i>In slab, w 65 ft cable</i> | |
|--|--|
| Literature | ES-WR-Snow_Ice-090, IOM-WR-Snow_Ice-090 |
| Packaged weight | 4.4 lbs (2000 g) |
| Dimensions | 1-3/4" H x 3-7/16" OD (45 mm H x 87 mm OD) |
| Sensor material | Silicon brass, 65 ft. (20 m) 5 conductor stranded wire with polyethylene jacket |
| Approvals | CSA C US with Watts Radiant Snow Melting Controls 653 and 654 |
| Operating range | -30 to 170°F (-34 to 77°C) |
| -Included | 4 #4-40, 7/16" machined, stainless steel screws 4 #6-32, 3/8" flathead, slotted, stainless steel screws |

| Snow/Ice Sensor Socket 091 | |
|-----------------------------------|--|
| Literature | ES-WR-Snow_Socket-091, IOM-WR-Snow_Ice-090 |
| Packaged weight | 1.5 lbs (670 g) |
| Socket material | Silicon brass |
| Dimensions | 3-13/16" H x 3-1/2" OD (97 mm H x 89 mm OD) |
| Approvals | CSA C US with Watts Radiant Snow/Ice Sensor 090 |
| -Included | One polyethylene protective cap, one polyethylene mounting plate and eight #6-32 x 3/8" screws |

WARNING: This product contains chemicals known to the State of California to cause cancer and birth defects or other reproductive harm.
For more information: www.watts.com/prop65

Hydronic System Electronic Controls and Thermostats Limited Warranty

Watts Radiant (the Company) warrants its hydronic system electronic controls and thermostats (the Product) to be free from defects in materials and workmanship under normal usage for a period of one year from the documented date of installation of the Product. In the event of defects within the warranty period, the Company will replace the Product without charge. This remedy is the sole and exclusive remedy for breach of warranty. This warranty is transferable to subsequent owners.

Under this Limited Warranty, the Company will provide the following:

In order to make a claim, you must:

- (a) Provide the Company with sufficient details relating to the nature of the defect, the installation, the history of operation, and any repairs that may have been made.
- (b) At the Company's discretion and at the owner's expense, ship the Product to the Company or the Company's local representative or distributor.
- (c) Provide proof that the Product was installed in accordance with the applicable Product Installation Manual and any special written design or installation guidelines by the Company for this project.
- (d) Provide proof that the Product was installed in accordance with the National Electrical Code (NEC) or the Canadian Electrical Code (CEC), and all applicable local building and electrical codes.
- (e) Provide a retail sales receipt or proof of purchase.

The following are not covered by this Limited Warranty:

- (a) Any incidental or consequential damage, including inconvenience, loss of time or loss of income.
- (b) Any labor or materials required to repair or replace the Product that are not authorized in writing by the Company.
- (c) Any labor or materials required to remove, repair or replace materials other than the Products.
- (d) Any freight or delivery costs related to the Product or any related electrical products.

Watts Radiant assumes no responsibility under this Limited Warranty for any damage to the Product caused by any trades people, visitors on the job site, or damage caused as a result of post-installation work. This Limited Warranty shall be invalidated by any abuse, misuse, misapplication or improper installation of the Products. The staff at the Company is available to answer any questions regarding the proper installation or application of the Product at this toll-free phone number: 800-276-2419 (USA/International) or 888-208-8927 (Canada). If you are ever in doubt about the correct installation procedure to follow, or if the Product appears to be damaged, you must call us before proceeding with the installation or proposed repair.

WATTS RADIANT DISCLAIMS ANY WARRANTY NOT PROVIDED HEREIN, INCLUDING ANY IMPLIED WARRANTY OF MERCHANTABILITY OR IMPLIED WARRANTY OF FITNESS FOR A PARTICULAR PURPOSE. WATTS RADIANT FURTHER DISCLAIMS ANY RESPONSIBILITY FOR SPECIAL, INDIRECT, SECONDARY, INCIDENTAL, OR CONSEQUENTIAL DAMAGES ARISING FROM OWNERSHIP OR USE OF THIS PRODUCT, INCLUDING INCONVENIENCE OR LOSS OF USE. THERE ARE NO WARRANTIES WHICH EXTEND BEYOND THE FACE OF THIS DOCUMENT. NO AGENT OR REPRESENTATIVE OF WATTS RADIANT HAS ANY AUTHORITY TO EXTEND OR MODIFY THIS WARRANTY UNLESS SUCH EXTENSION OR MODIFICATION IS MADE IN WRITING BY A CORPORATE OFFICER.

Some states/provinces do not allow the exclusion or limitation of incidental or consequential damages and some states/provinces do not allow limitations on how long implied warranties may last. Therefore, the above limitations or exclusions may not apply to you. This warranty gives you specific legal rights and you may also have other rights, which vary from state to state or province to province. SO FAR AS IS CONSISTENT WITH APPLICABLE STATE/PROVINCIAL LAW, ANY IMPLIED WARRANTIES THAT MAY NOT BE DISCLAIMED, INCLUDING IMPLIED WARRANTIES OF MERCHANTABILITY OR FITNESS FOR A PARTICULAR PURPOSE ARE LIMITED IN DURATION TO ONE YEAR FROM THE DATE OF MANUFACTURE.

Effective: May 1, 2013. This warranty applies to all Products purchased after this date.

WattsRadiant[™]

A Watts Water Technologies Company

USA: Springfield, MO • Tel. (800) 276-2419 • Fax: (417) 864-8161 • www.wattsradiant.com

Canada: Burlington, ONT. • Tel. (905) 332-4090 • Fax: (905) 332-7068 • www.watts.ca