

Quick Setup Guide

1. Location

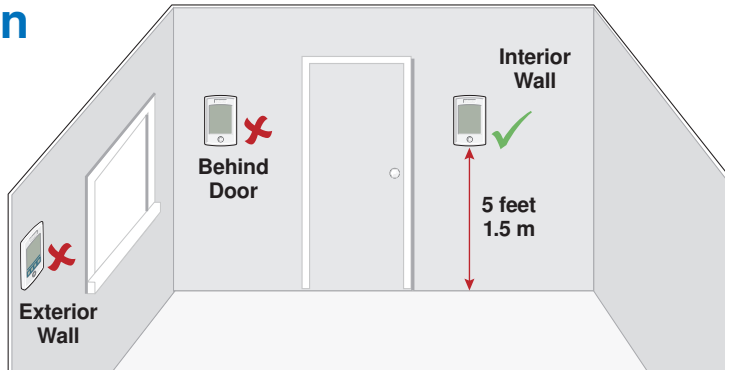

2. Remove Mounting Base

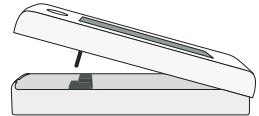
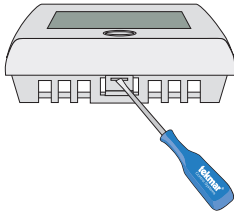

3. Install Mounting Base

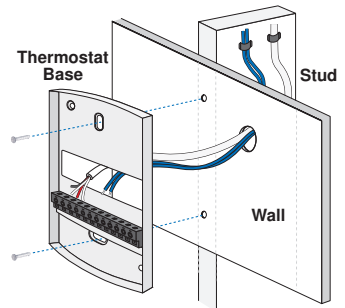
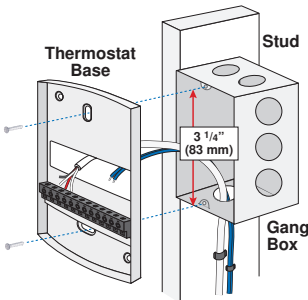

4. Switch Settings

Switch	Position	Action
1	ON	LOCK Access level adjustment is not available.
	OFF	UNLOCK Access level adjustment is available.

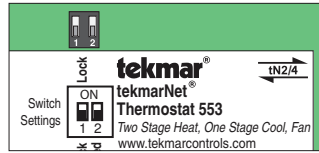

Back of Thermostat

5. Wiring

tekmarNet®4 Wiring Example

See 553_A for complete wiring details.

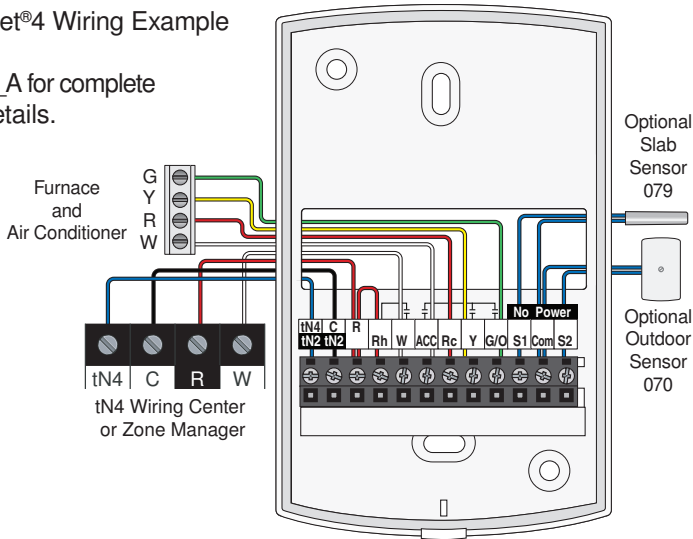

tekmarNet®2 Wiring Example

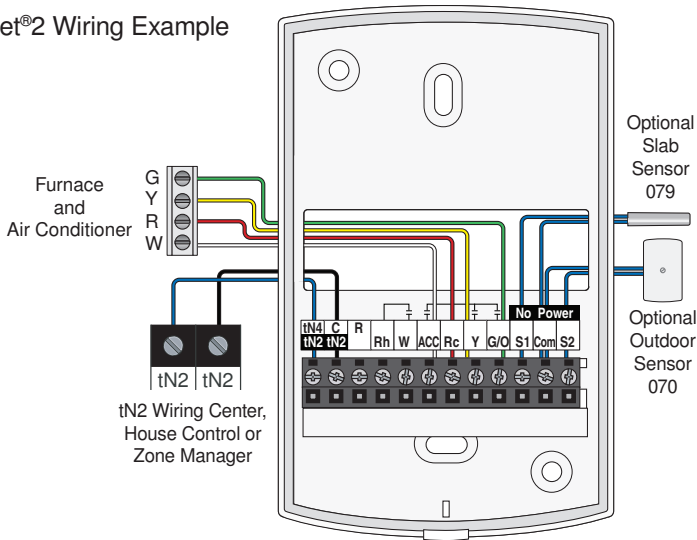

6. Install the Thermostat

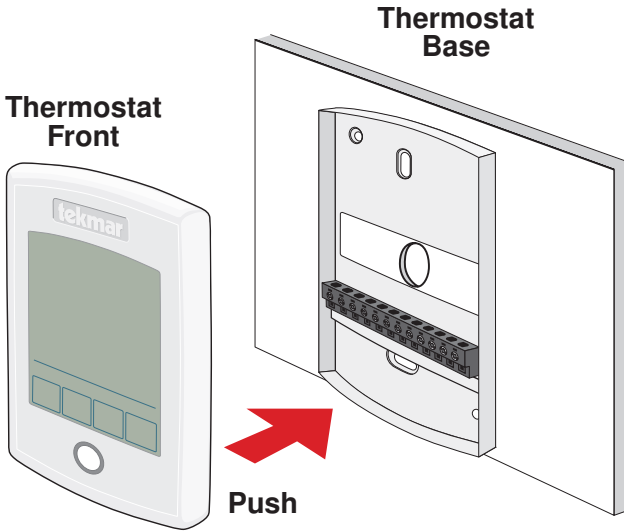

7. User Interface

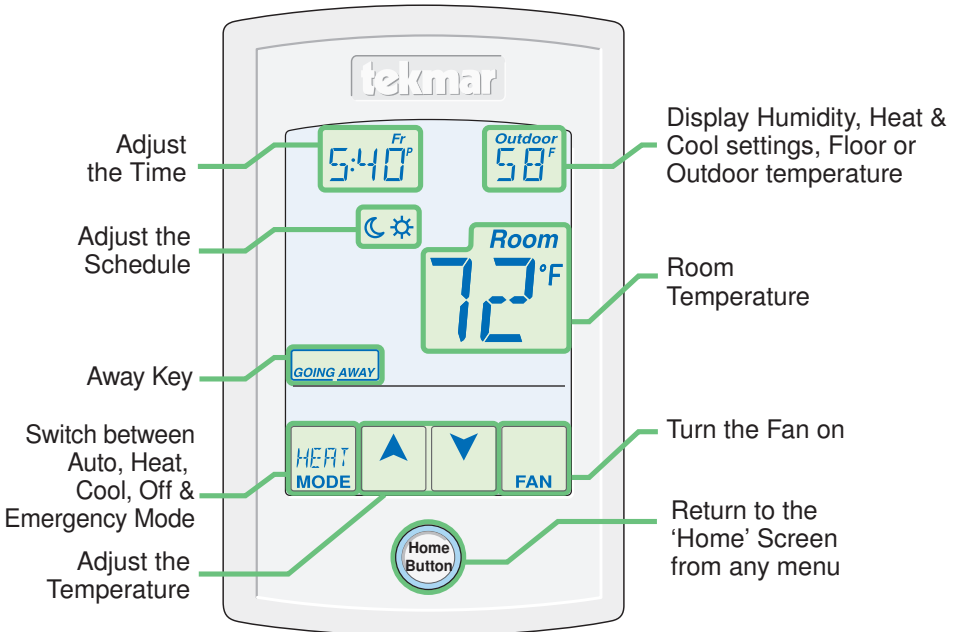

8. Critical Settings

The following settings are essential to the successful operation of the system.

Step 1: Set switch setting #1 and tekmarNet® system control located in the mechanical room to Unlock to change Access level to Installer. Return to Lock setting once installation has been completed.

Step 2: Press and hold “Home” button for 3 seconds to enter programming menus.

Step 3: Touch NEXT to locate the Setup Menu and touch ENTER.

Setup Menu Settings	Range	Default
SENSOR 1 Select the type of sensor connected to auxiliary sensor input 1.	OFF, ROOM, FLOR (floor), COIL, DUCT	OFF
SENSOR 2 Select the type of sensor connected to auxiliary sensor input 2.	OFF, ROOM, FLOR (floor), OUT (outdoor)	OFF
ROOM SENSOR Select if the built-in room temperature sensor is on or off.	OFF or ON	ON
HUMIDITY SENSOR Select if the built-in humidity sensor is on or off.	OFF or ON	ON
Y RELAY Select the cooling equipment the Y relay operates.	OFF, HP (heat pump), AC (air conditioner), HUM (humidity)	AC
W TERMINAL UNIT Select the terminal unit type of the first stage of heat W.	NONE, HRF1, HRF2, CONV, COIL, FURN, OTHR	HRF1 (tekmarNet® System Control) OTHR (standalone)
ACC RELAY Select the operation of the accessory relay.	OFF, W2, HUM, DHUM, HRV, FAN	W2
W2 TERMINAL UNIT Select the type of backup heating.	CONV, COIL, FURN (furnace), OTHR (other)	FURN
W2 SOURCE Select the second stage W2 hydronic heat source.	BOIL, TANK, MIX	BOIL
G/O RELAY Select the equipment the G / O relay operates.	FAN or OFF (conventional heating) O or B (heat pump)	FAN (conventional) O (heat pump)

For a full list of settings and operational details, please refer to the thermostat **Installation and Operation Manual (553_D)** available from www.tekmarControls.com



Product design, software and literature are Copyright ©2014 by tekmar Control Systems Ltd., A Watts Water Technologies Company. Head Office: 5100 Silver Star Road, Vernon, B.C. Canada V1B 3K4, 250-545-7749, Fax. 250-545-0650 Web Site: www.tekmarControls.com



Guide d'installation rapide

1. Emplacement

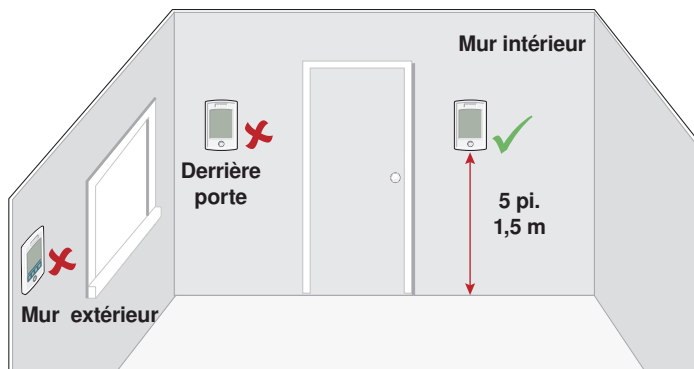

2. Retirez la base de montage

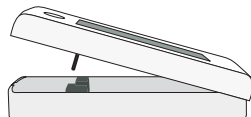
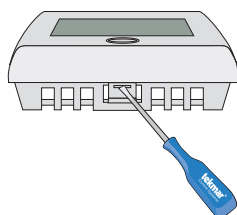

3. Installez la base de montage

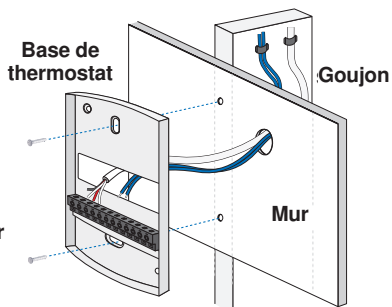
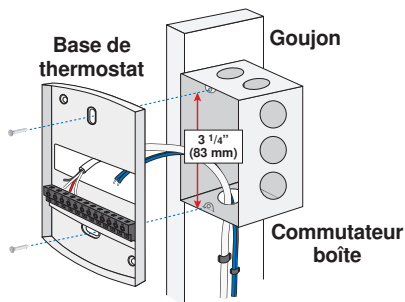

4. Réglages des commutateurs

Commutateur	Position	Action
1	ON	VERROUILLAGE Le réglage du niveau d'accès n'est pas disponible.
	OFF	DÉVERROUILLAGE Le réglage du niveau d'accès est disponible.

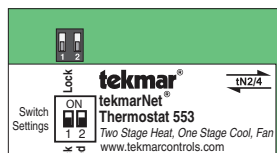

Dos du thermostat

5. Filage

tekmarNet®4 exemple de filage

Référence 553_A pour plus de détails sur le filage complet.

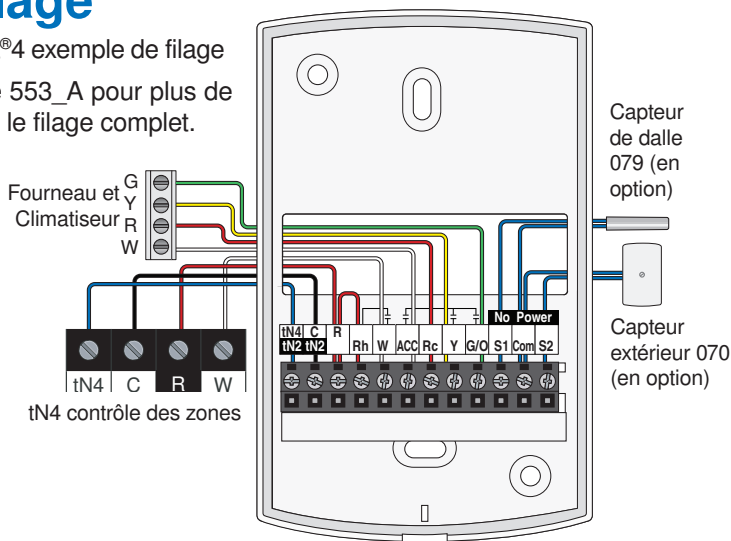

tekmarNet®2 exemple de filage

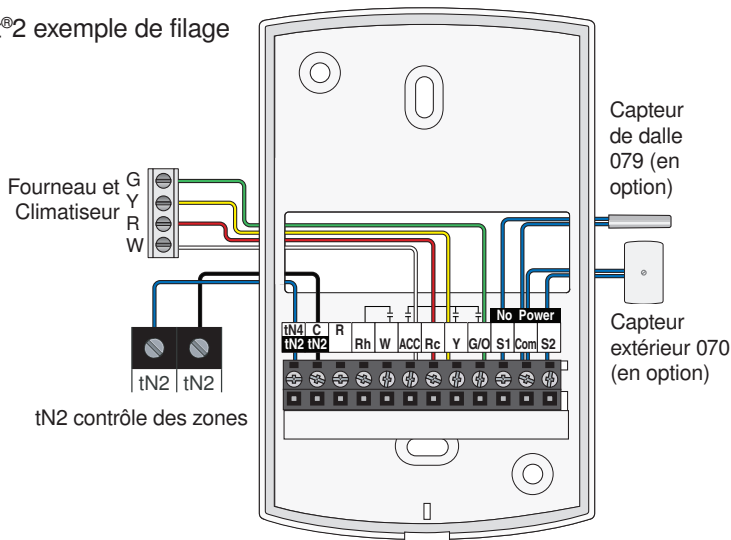

6. Installer le Thermostat

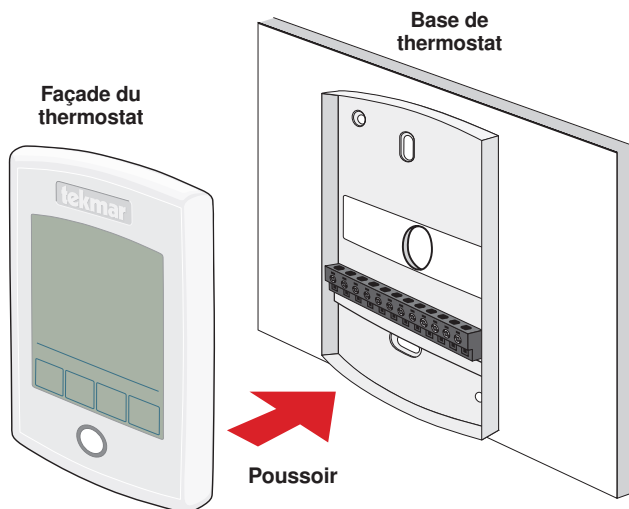

7. Interface d'utilisateur

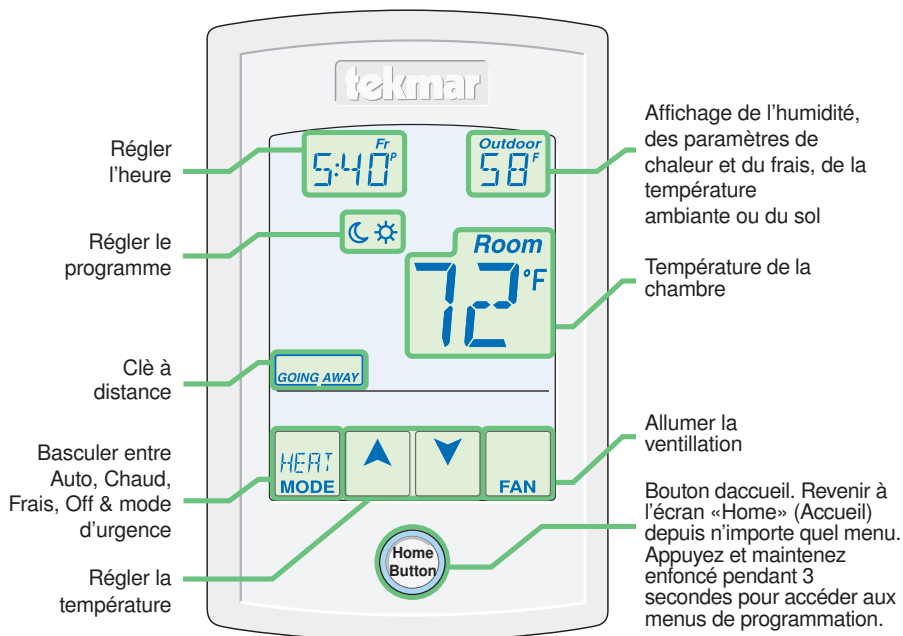

8. Paramètres critiques

Les paramètres suivants sont essentiels au bon fonctionnement du système.

Étape 1: Définir le réglage du commutateur sur #1 et le système de contrôle tekmarNet® situé dans la salle mécanique sur Déverrouiller pour changer le niveau d'accès à l'installateur. Retour pour Verrouiller réglage, une fois l'installation terminée.

Étape 2: Appuyez et maintenez le bouton «Home» pendant 3 secondes pour entrer dans les menus de programmation.

Étape 3: Touchez SUIVANT pour localiser le menu de configuration et appuyez sur ENTRER.

Réglages du menu de configuration	Gamme	Par défaut
CAPTEUR 1 Sélectionner le type de capteur relié à l'entrée auxiliaire du capteur 1.	OFF, ROOM, FLOR (sol), COIL, DUCT	OFF
CAPTEUR 2 Sélectionner le type de capteur relié à l'entrée auxiliaire du capteur 2.	OFF, ROOM, FLOR (sol), OUT (en plein air)	OFF
CAPTEUR DE CHAMBRE Sélectionnez si le capteur intégré de la température ambiante est allumé ou éteint.	OFF ou ON	ON
CAPTEUR D'HUMIDITÉ Sélectionnez si le capteur d'humidité intégré est activé ou pas.	OFF ou ON	ON
RELAIS Y Sélectionnez l'équipement de refroidissement que relais Y active.	OFF, HP (pompe à chaleur), AC (climatiseur), HUM (humidité)	AC
UNITÉ DU TERMINALE W Sélectionnez le type d'unité du terminal de la première étape de chauffage W.	NONE, HRF1, HRF2, CONV, COIL, FURN, OTHR	HRF1 (tekmarNet® Contrôle de Système) OTHR (autonome)
RELAIS ACCESSOIRE Sélectionnez l'appareil que le relais accessoire active.	OFF, W2, HUM, DHUM, HRV, FAN (ventilateur)	W2
UNITÉ DU TERMINALE W2 Sélectionnez le type de chauffage d'appoint.	CONV, COIL, FURN (fourneau), OTHR (autre)	FURN
SOURCE DE W2 Sélectionnez la source de chaleur hydroniques de la deuxième étape W2.	BOIL (ébullition), TANK (réservoir), MIX (mélange)	BOIL (ébullition)
RELAIS G/O Sélectionnez l'équipement le relais G / O est ouvert.	FAN (ventilateur) ou OFF (chauffage conventionnel) O ou B (pompe à chaleur)	FAN (ventilateur) (classique) O (pompe à chaleur)

Pour une liste complète des paramètres et les détails opérationnels, s'il vous plaît se référer à **l'installation du thermostat et mode d'emploi (553_D)** disponible sur www.tekmarControls.com



Conception de produit, logiciel et littérature sont des droits réservés ©2014 par tekmar Control Systems Ltd., Une Entreprise de Watts Water Technologies. Bureau Principal: 5100 Silver Star Road, Vernon, B.C. Canada V1B 3K4, 250-545-7749, Téléc: 250-545-0650 Site Web: www.tekmarControls.com

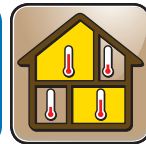

División en zonas

553_Q
02/14

Remplazado por: 01/14

Guía de instalación rápida

1. Ubicación

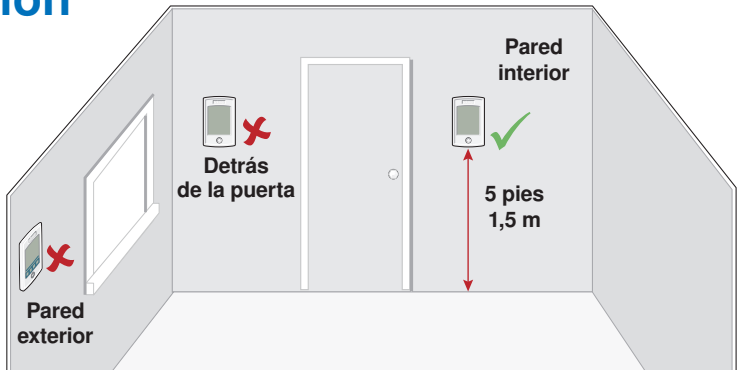

2. Quite la base de montaje

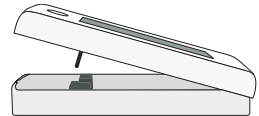
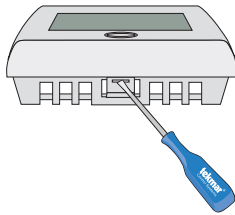

3. Instalación de la base de montaje

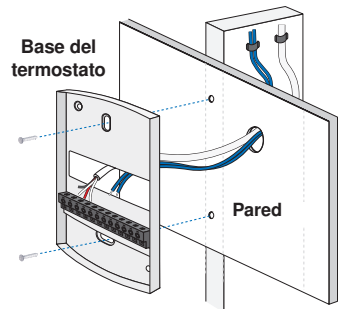
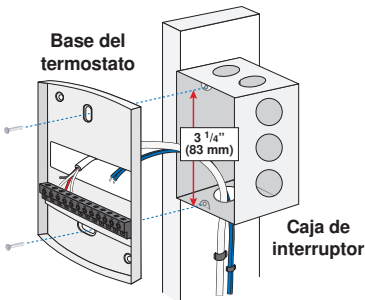

4. Ajustes del interruptor

Interruptor	Posición	Acción
1	ON	LOCK (BLOQUEADO) el nivel de acceso para ajustes se encuentra bloqueado.
	OFF	UNLOCK (DESBLOQUEADO) el nivel de acceso para ajustes se encuentra disponible.

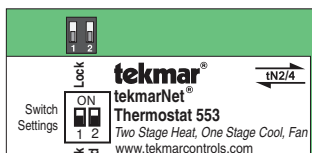

Parte trasera del termostato

5. Cableado

tekmarNet®4 ejemplo de cableado

Referencia 553_A para detalles completos del cableado.

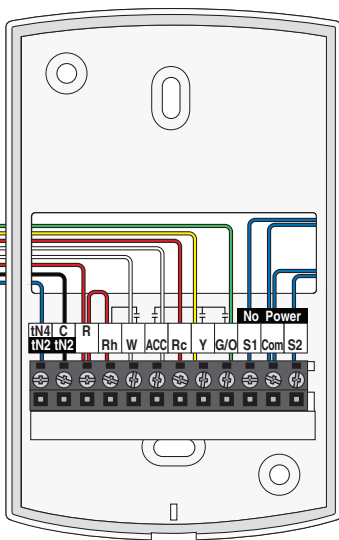
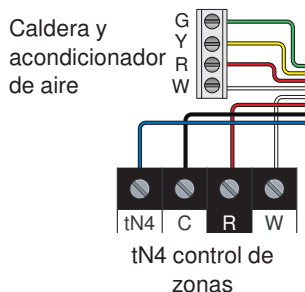

Sensor de losa opcional 079

Sensor de exterior opcional 070

tekmarNet®2 ejemplo de cableado

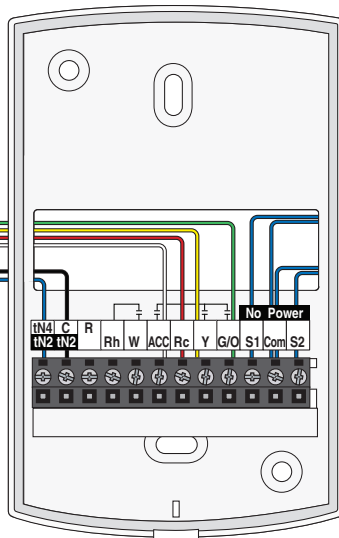
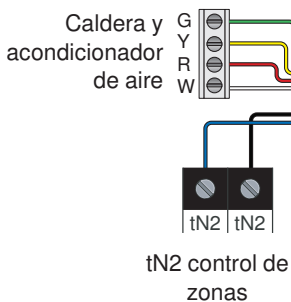

Sensor de losa opcional 079

Sensor de exterior opcional 070

6. Instalación del termostato

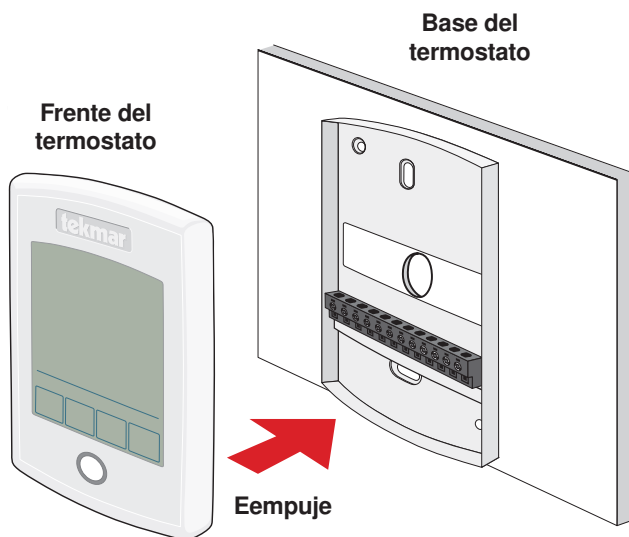

7. Interfaz del usuario

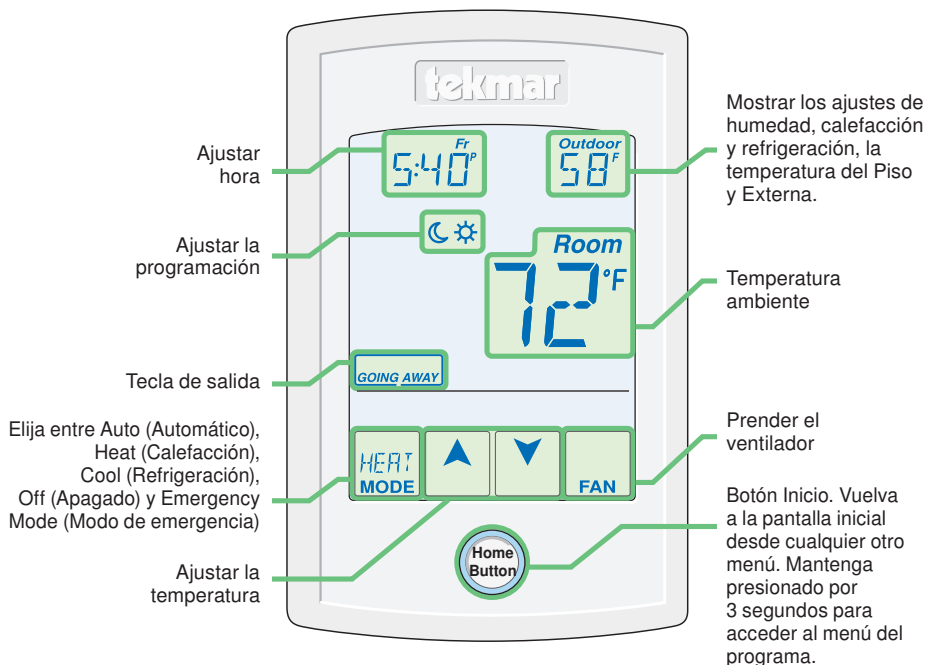

8. Ajustes críticos

Las siguientes configuraciones son esenciales para que el sistema trabaje de manera correcta.

Paso 1: Desbloquee (opción UNLOCK) el ajuste número uno del interruptor y del control del sistema tekmarNet® para cambiar el nivel de accesibilidad a Instalador. Cámbielo nuevamente a Bloquear (opción Lock) luego de finalizar la instalación.

Paso 2: Mantenga presionado el botón "Home" por 3 segundos para ingresar a los menús de programación.

Paso 3: Presione el botón NEXT (SIGUIENTE) para localizar el menú de SETUP (Instalación) y presione ENTER (ENTRAR).

Ajustes del menú de instalación	Rango	Predeterminado
SENSOR 1 Seleccione el tipo de sensor conectado a la entrada número 1 para sensor auxiliares.	OFF, ROOM, FLOR (piso), COIL, DUCT	OFF
SENSOR 2 Seleccione el tipo de sensor conectado a la entrada número 2 para sensor auxiliares.	OFF, ROOM (ambiente), FLOR (piso), OUT (exterior)	OFF
SENSOR AMBIENTE Prenda o apague el sensor integrado de la temperatura del aire en el ambiente.	OFF o ON	ON
SENSOR DE HUMEDAD Seleccione si el sensor de humedad integrado estará prendido o apagado.	OFF o ON	ON
RELÉ Y Seleccione el equipo de refrigeración que accionara el relé Y.	OFF, HP (bomba de calor), AC (acondicionador de aire), HUM (humedad)	AC
TIPO DE TERMINAL W Seleccione el tipo de unidad terminal de la primera etapa de calefacción W.	NONE (Ninguna), HRF1, HRF2, CONV, COIL, FURN, OTHR	HRF1 (Sistema de control tekmarNet®) OTHR (Otro)
RELÉ ADICIONAL Seleccione el equipo que el relé adicional accionará.	OFF, W2, HUM, DHUM, HRV, FAN	W2
TIPO DE TERMINAL W2 Seleccione el tipo de calefacción de respaldo.	CONV, COIL, FURN (caldera), OTHR (otro)	FURN
FUENTE W2 Seleccione la fuente de calefacción hidrónica W2 de segunda etapa.	BOIL, TANK, MIX	BOIL
RELÉ G/O Seleccione el equipo que el relé G/O utiliza.	FAN (ventilador) o OFF (calefacción convencional) O o B (bomba de calefacción)	FAN (onvencional) O (bomba de calefacción)

Para una lista completa de ajustes y detalles funcionales, por favor diríjase al **Manual de Instalación y manejo del termostato (553_D)** disponible en www.tekmarControls.com



El diseño del producto, software y la literatura poseen derechos reservados ©2014 a nombre de tekmar Control Systems Ltd., Una Compañía de Watts Water Technologies Oficina Principal: 5100 Silver Star Road, Vernon, B.C. Canadá V1B 3K4, 250-545-7749, Fax. 250-545-0650 Sitio web: www.tekmarControls.com

