



Zoning

**552\_D**

09/14

Replaces: 08/11

# Installation & Operation Manual

## Introduction

The tekmarNet<sup>®</sup> Thermostat 552 provides operation for:

- One Stage Heat

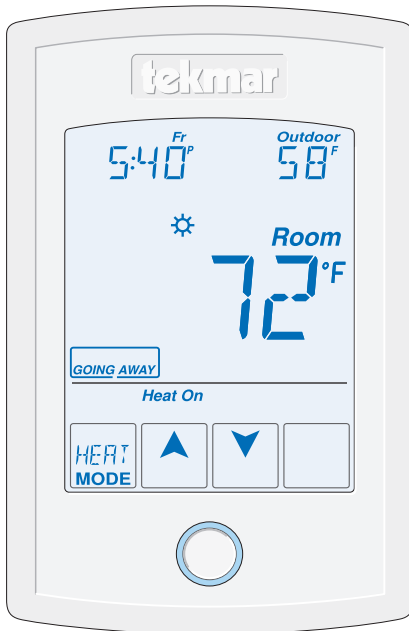

## Features

- Touchscreen
- Bright Backlight
- tekmarNet<sup>®</sup> Communication
- Outdoor Temperature Display
- Floor Temperature Display
- 7-Day, 4 Event Programmable Schedule
- Optimum Start
- Scenes
- Away Key
- Air Group Member
- Freeze Protection
- Exercise Pump or Valves
- Zone Synchronization
- Two Auxiliary Sensor Inputs

## Benefits

- Simple to Use
- Increased Comfort Through Precise Temperature Control
- Conserves Energy
- Convenience Through Internet Connectivity
- Warm Radiant Floors
- Protects Radiant Floors From Over Heating

## Table of Contents

Getting Started .....	4
Installation .....	4
Preparation.....	4
Removing The Thermostat Base .....	5
Mounting The Thermostat Base.....	5
Thermostat Wiring.....	6
Compatible Sensors.....	7
Testing the Thermostat Wiring .....	8
Mounting the Thermostat .....	10
Cleaning the Thermostat.....	10
Switch Settings .....	11
User Interface .....	12
Home Screen .....	12
Symbols Description .....	12
Programmable Settings .....	13
Programming Menus.....	13
Set Temp Menu .....	14
Time Menu .....	17
Schedule Menu .....	19
Display Menu .....	20
Scenes Menu .....	21
Monitor Menu .....	22
Toolbox Menu.....	24
Setup Menu.....	27
Sequence of Operation.....	29
Heating Operation .....	29
Air Group Operation .....	31
Time Clock .....	31
Temperature Adjustment.....	32
Programmable Schedules.....	33
Scenes (System Override).....	34
Secondary Temperature Display.....	35
Access Levels .....	36
tekmarNet® Address.....	36
Screen Clean Menu .....	36
Troubleshooting .....	33
Error Messages.....	37
Frequently Asked Questions .....	42
Technical Data .....	43
Limited Warranty and Product Return Procedure .....	44

## Important Safety Information

It is your responsibility to ensure that this thermostat is safely installed according to all applicable codes and standards. tekmar is not responsible for damages resulting from improper installation and/or maintenance.



This is a safety-alert symbol. The safety alert symbol is shown alone or used with a signal word (DANGER, WARNING, or CAUTION), a pictorial and/or a safety message to identify hazards.

When you see this symbol alone or with a signal word on your equipment or in this Manual, be alert to the potential for death or serious personal injury.



This pictorial alerts you to electricity, electrocution, and shock hazards.

### **WARNING**

This symbol identifies hazards which, if not avoided, could result in death or serious injury.

### **CAUTION**

This symbol identifies hazards which, if not avoided, could result in minor or moderate injury.

### **NOTICE**

This symbol identifies practices, actions, or failure to act which could result in property damage or damage to the equipment.

### **WARNING**



Read Manual and all product labels BEFORE using the equipment. Do not use unless you know the safe and proper operation of this equipment. Keep this Manual available for easy access by all users. Replacement Manuals are available at [tekmarControls.com](http://tekmarControls.com)

### **WARNING**

- It is the installers responsibility to ensure that this thermostat is safely installed according to all applicable codes and standards.
- Improper installation and operation of this thermostat could result in damage to the equipment and possibly even personal injury or death.
- This thermostat is not intended for use as a primary limit control. Other controls that are intended and certified as safety limits must be placed into the control circuit.

### **NOTICE**

Do not attempt to service the thermostat. There are no user serviceable parts inside the thermostat. Attempting to do so voids warranty.

## Getting Started

Congratulations on the purchase of your new tekmar thermostat.

This manual will step through the complete installation, programming and sequence of operation for this control. At the back, there are tips for control and system troubleshooting.

# Installation

## Preparation

### Tools Required

- tekmar or jeweller screwdriver
- Wire Stripper
- Phillips head screwdriver

### Materials Required

- 18 AWG LVT Solid Wire  
(Low Voltage Connections)

### Installation Location

Choose the placement of the thermostats early in the construction process to enable proper wiring during rough-in.

### NOTICE

Consider the following:

- Interior Wall.
- Keep dry. Avoid potential leakage onto the control.
- Relative Humidity less than 90%. Non-condensing environment.
- No exposure to extreme temperatures beyond 32-122°F (0-50°C).
- No draft, direct sun, or other cause for inaccurate temperature readings.
- Away from equipment, appliances, or other sources of electrical interference.
- Easy access for wiring, viewing, and adjusting the display screen.
- Approximately 5 feet (1.5 m) off the finished floor.
- The maximum length of wire is 500 feet (150 m).
- Strip wire to 3/8" (10 mm) for all terminal connections.
- Use standard 8 conductor, 18 AWG wire.

### ⚠ WARNING



To prevent the risk of personal injury and/or death, make sure power is not applied to the thermostat until it is fully installed and ready for final testing. All work must be done with power turned off to the circuit being worked on.

Please be aware local codes may require this thermostat to be installed or connected by an electrician.

## Removing The Thermostat Base

To remove the thermostat base:

- Locate the tab on the bottom of the thermostat.
- Push the tab with either your thumb or with a screwdriver.
- Lift the thermostat front away from the thermostat's base.

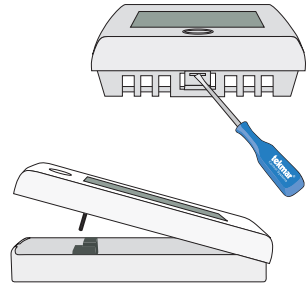

## Mounting The Thermostat Base

If a single gang box is used:

- Feed the wiring through the large hole of the thermostat base.
- Fasten the base of the thermostat to the gang box.
- Terminate wiring to the wiring strip.
- Push the thermostat front onto the thermostat base.

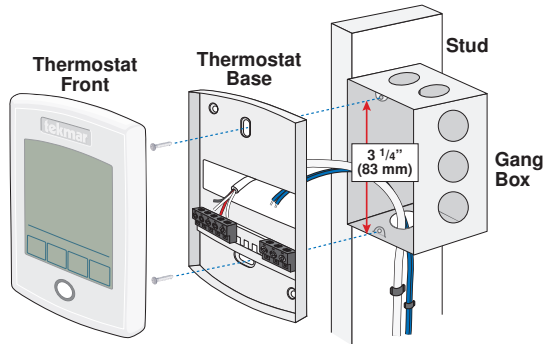

If a gang box is not used:

- Feed the wiring through the large hole in the thermostat base.
- Mount the thermostat base directly to the wall.
- Use screws in the screw holes to fasten the thermostat to the wall. At least one of the screws should enter a wall stud or similar rigid material.
- Terminate wiring to the wiring strip.
- Push the thermostat front onto the thermostat base.

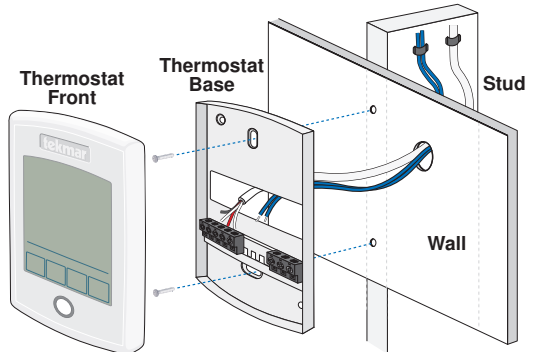

## Thermostat Wiring

The thermostat operates a single heating system zone and can be wired in four different ways.

**tekmarNet®2** - Allows the thermostat to be wired point-to-point using 2 wires to a tekmarNet®2 Wiring Center, House Control, or Zone Manager. This allows easy wiring for retrofit applications.

**tekmarNet®4** - Allows the thermostat to be wired using 4 wires to a tekmarNet Wiring Center or Zone Manager point-to-point. Alternatively, the thermostat can operate heating equipment locally and the tN4 communication bus can be daisy-chained from one thermostat to another.

**Stand Alone** - Simple 3 wire connection to a 24 V (ac) transformer and zone valve.

**Stand Alone** - Simple 3 wire connection to a switching relay or zone valve control.

### Wiring - tekmarNet®2

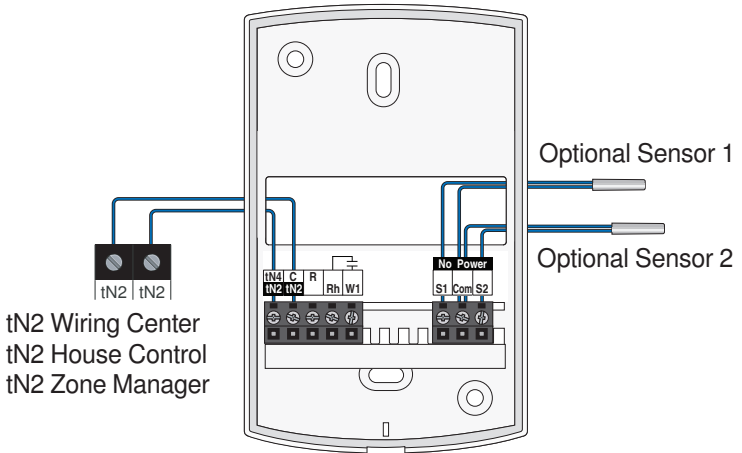

### Wiring - tekmarNet®4

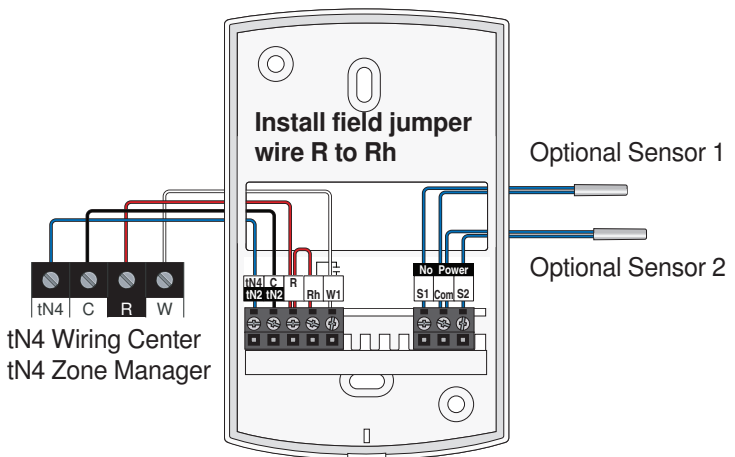



## **▲ CAUTION**

Only qualified personnel should perform testing procedures. A licensed electrician is recommended.

## **Testing the Thermostat Wiring**

### **Testing tekmarNet®2 Wiring**

#### **Testing the Power**

If the thermostat display turns on, this indicates that the thermostat is operating correctly and there are no electrical issues. In the event that the display is off, or the display is cycling on and off:

1. Remove the thermostat front.
2. Use an electrical meter to measure DC voltage between the tN2 terminals.
  - If the DC voltage is 0 V (dc) for at least 20 seconds, then there is an open or short circuit in the tN2 wires.
  - If the DC voltage is 0 V (dc) for 10 seconds and then is 23 to 24 V (dc) for 5 seconds, this indicates the wiring is correct.
3. Connect the thermostat to the tN2 wires connected to a zone on a House Control, Wiring Center, or Zone Manager.
4. If the thermostat display is off, or is cycling on and off, move the thermostat to the next available zone on the House Control, Wiring Center, or Zone Manager.
  - If the thermostat display remains permanently on, there may be a fault with the previously tried zone on the House Control, Wiring Center, or Zone Manager.
  - If the thermostat display continues to be off, or is cycling on and off, there may be a fault on the thermostat.

If a fault is suspected, contact your tekmar sales representative for assistance.

#### **Testing the Heat Zone Output Wiring**

1. Touch the ▲ button and set the heating temperature above the current room temperature. Make sure the display does not show “WWSD” or “Floor Max”.
2. When the “Heat On” symbol appears on the display, use an electrical meter to check for voltage on the House Control, Wiring Center, or Zone Manager relay. The voltage is 24 V (ac) for zone valves, and 120 V (ac) for zone pumps when operating correctly.



## Testing tekmarNet®4 and Stand Alone Wiring

---

### Testing the Power

1. Remove the front cover from the thermostat.
2. Use an electrical test meter to measure (ac) voltage between the R and C terminals. The reading should be 24 V (ac) +/- 10%.
3. Install the front cover.

### Testing the Heat Relay

1. Remove the front cover from the thermostat.
2. Touch the ▼ button and set the heating temperature below the current room temperature. There should be no “Heat On” symbol on the display.
3. Set the electrical test meter to continuity.
4. Place electrical meter probes between R and W. There should be no continuity. If there is continuity then there may be a wiring fault or the relay may be faulty.
5. Touch the ▲ button and set the heating temperature above the current room temperature. Make sure the display does not show “WWSD”. The “Heat On” symbol should appear on the display.
6. There should now be continuity between the R and W terminals.

### Testing the tekmarNet®4 Bus Wiring

The ⇌ symbol is shown on the display when communication is present. If the thermostat is connected in a network and the communication is missing, there may be an open or short circuit on the tN4 and C bus wires.

1. Remove the front cover from the thermostat.
2. To test for short circuits:
  - Disconnect the tN4 bus wires on one end.
  - Install wire nuts on each wire to ensure the wire ends are not touching.
  - Disconnect the tN4 bus wires on the other end.
  - Measure for continuity using an electrical meter.
  - If continuity is present, there is a short circuit fault along the wires. It is recommended to replace the tN4 bus wires.
3. To test for open circuits:
  - Disconnect the tN4 bus wires on one end and connect them together.
  - Disconnect the tN4 bus wires on the other end.
  - Use an electrical meter to measure for continuity.
  - If there is no continuity, there is an open circuit fault along the wires. It is recommended to replace the tN4 bus wires.

## Mounting the Thermostat

Push the thermostat front onto the thermostat base. Installation is now complete.

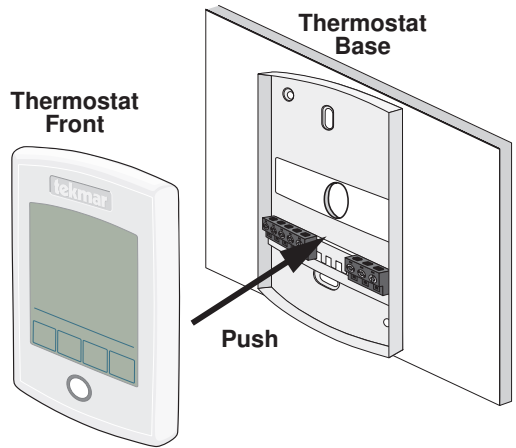

## Cleaning the Thermostat

The thermostat's exterior can be cleaned using a damp cloth. Moisten the cloth with water and wring out prior to wiping the control. Do not use solvents or cleaning solutions.

# Switch Settings

Back of  
Thermostat

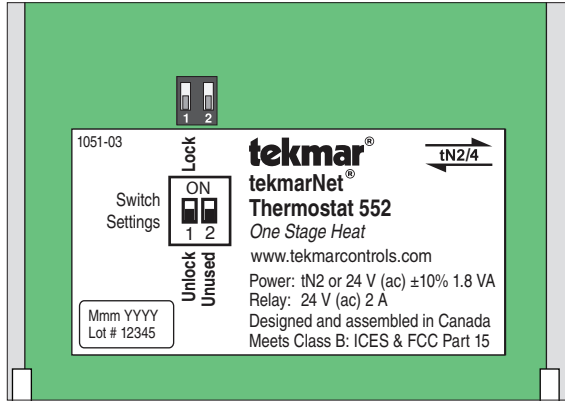

## Switch Position Action

Switch Position Action		
1	ON	<b>LOCK ACCESS LEVEL</b> Thermostat is locally locked and the access level cannot be changed. Set to Lock when installation has been completed.
	OFF	<b>UNLOCK ACCESS LEVEL</b> Thermostat is unlocked and the access level may be changed. Go to the Toolbox menu to change the access level. Set to Unlock during the installation process. Note: tekmarNet® system controls include a Global Lock that locks all connected thermostats. Set the tekmarNet® system control to unlock to allow access level adjustment on all connected thermostats.

# User Interface

## Home Screen

The touchscreen of the 552 provides one touch access to these settings.

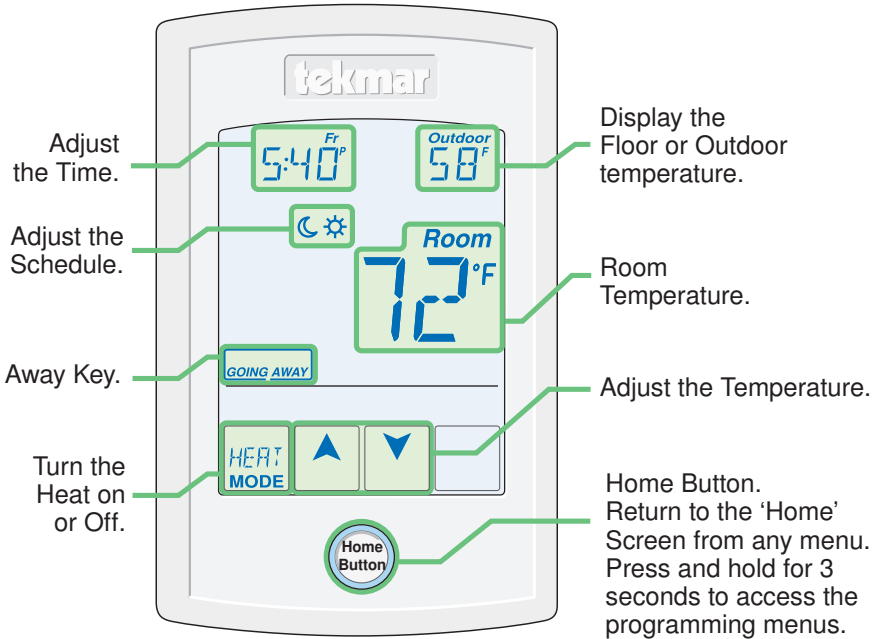

## Symbols Description

<i>Heat On</i>	<b>HEAT ON</b> Heat is turned on.	<i>SCENE AWAY</i>	<b>SCENE AWAY</b> Operating at Away temperature.
	<b>SUN</b> Operating at the occupied (day) temperature.	<i>HOLD 3hr</i>	<b>TEMPORARY HOLD</b> Hold for 3, 6, 9 or 12 hours.
	<b>MOON</b> Operating at the unoccupied (night) temperature.	<i>WWS D</i>	<b>WWS D</b> Warm Weather Shut Down.
	<b>tekmarNet®</b> Communication is present.	<i>COOL</i>	<b>COOL</b> Cooling system is on.
	<b>WARNING SYMBOL</b> Indicates an error is present.	<i>MIN MAX</i>	<b>MIN or MAX</b> Reached the room min or max.
	<b>ARROWS</b> Adjust the displayed setting.	<i>MIN FL MAX FL</i>	<b>MIN FL or MAX FL</b> Reached the floor min or max.

# Programmable Settings

## Programming Menus

Press and hold the Home button for 3 seconds to enter the programming menus. The thermostat returns to the last programming menu previously used.

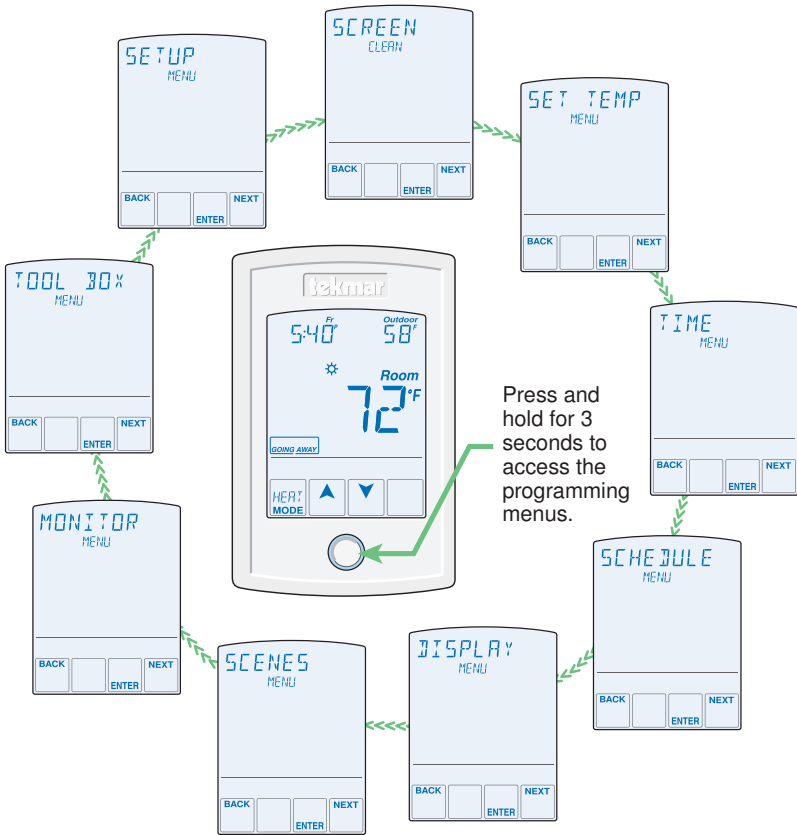

## Select a Programming Menu

- Touch “NEXT” to advance (clockwise in above illustration) to the next menu.
- Touch “BACK” to go backwards (counterclockwise in above illustration) through the menus.
- Touch “ENTER” to enter a menu.

## Setting Items

- Touch ▲ or ▼ arrow to adjust the setting if required.
- Touch “NEXT ITEM” to advance to the next item within the menu.
- Touch “BACK ITEM” to go backwards to the previous item within the menu.
- To return to the parent menu after changing a setting, press and release the home button.
- To return to the home screen, press and release the home button twice or wait 30 seconds to automatically return to the home screen.

Set Temp Menu (1 of 3)	
Setting	Display
<b>SET HEAT ROOM ☼</b> Set the room heating temperature during the ☼ event.	<b>SET HEAT Room</b> ☼
Access Level: Installer, User	Range: 40 to 95°F (4.5 to 35.0°C)
Conditions: Room Sensor set to ON or Sensor 1 or Sensor 2 set to Room.	Default: 70°F (21.0°C)
<b>SET HEAT ROOM ☾</b> Set the room heating temperature during the ☾ event.	<b>SET HEAT Room</b> ☾
Access Level: Installer, User	Range: 40 to 95°F (4.5 to 35.0°C)
Conditions: Room Sensor set to ON or Sensor 1 or Sensor 2 set to Room, and Schedules are in use or Scenes are set to All or Guest.	Default: 65°F (18.5°C)
<b>SET HEAT ROOM AWAY</b> Set the room heating temperature during the Away scene.	<b>SET HEAT Room</b> AWAY
Access Level: Installer, User	Range: 40 to 95°F (4.5 to 35.0°C)
Conditions: Room Sensor set to ON or Sensor 1 or Sensor 2 set to Room, and Scenes is set to Away, All or Guest.	Default: 62°F (16.5°C)
<b>ROOM MAX ☼</b> Set the maximum room heating limit while in the ☼ event.	<b>ROOM MAX</b> ☼
Access Level: Installer	Range: 40 to 95°F (4.5 to 35.0°C)
Conditions: Room Sensor set to ON or Sensor 1 or Sensor 2 set to Room.	Default: 85°F (29.5°C)
<b>ROOM MAX ☾</b> Set the maximum room heating limit while in the ☾ event.	<b>ROOM MAX</b> ☾
Access Level: Installer	Range: 40 to 95°F (4.5 to 35.0°C)
Conditions: Room Sensor set to ON or Sensor 1 or Sensor 2 set to Room, and Schedules are in use or Scenes are set to All or Guest.	Default: 85°F (29.5°C)
<b>SET HEAT FLOOR ☼</b> Set the floor heating temperature while in the ☼ event.	<b>SET HEAT</b> ☼ <b>Floor</b>
Access Level: Installer, User	Range: 40 to 122°F (4.5 to 50.0°C)
Conditions: Room Sensor set to OFF and Sensor 1 or Sensor 2 set to Floor.	Default: 72°F (22.0°C)

Set Temp Menu (2 of 3)	
Setting	Display
<b>SET HEAT FLOOR ☾</b> Set the floor heating temperature while in the ☾ event.	<b>SET HEAT</b> ☾ <i>Floor</i>
Access Level: Installer, User	Range: 40 to 122°F (4.5 to 50.0°C)
Conditions: Room Sensor set to OFF and Sensor 1 or Sensor 2 set to Floor, and Schedules are in use or Scenes are set to All or Guest.	Default: 65°F (18.5°C)
<b>WARM WEATHER SHUT DOWN ✱</b> Set the outdoor air temperature at which heating is suspended during the ✱ event.	<b>WWS D</b> ☼
Access Level: Installer	Range: CTRL (control), 40 to 100°F (4.5 to 38.0°C), OFF
Conditions: Always available	Default: CTRL
<b>WARM WEATHER SHUT DOWN ☾</b> Set the outdoor air temperature at which heating is suspended during the ☾ event.	<b>WWS D</b> ☾
Access Level: Installer	Range: CTRL (control), 40 to 100°F (4.5 to 38.0°C), OFF
Conditions: Requires that Schedules are in use or Scenes is set to All or Guest.	Default: CTRL
<b>FLOOR MINIMUM ✱</b> Set the floor heating temperature while in the ✱ event.	<b>FLOOR MIN</b> ☼
Access Level: Installer, User	Range: OFF, 40 to 122°F (4.5 to 50.0°C)
Conditions: Sensor 1 or Sensor 2 set to Floor, and either Room Sensor set to ON, or Room Sensor set to OFF while Sensor 1 or 2 is set to Room.	Default: 72°F (22.0°C)
<b>FLOOR MINIMUM ☾</b> Set the floor heating temperature while in the ☾ event.	<b>FLOOR MIN</b> ☾
Access Level: Installer, User	Range: OFF, 40 to 122°F (4.5 to 50.0°C)
Conditions: Sensor 1 or Sensor 2 set to Floor, and either Room Sensor set to ON, or Room Sensor set to OFF while Sensor 1 or 2 is set to Room, Schedules are in use or Scenes are set to All or Guest.	Default: OFF

## Set Temp Menu (3 of 3)

Setting	Display
<p><b>FLOOR MAXIMUM</b></p> <p>Set the floor maximum temperature in order to protect the floor covering. Suggested settings: Tile = 90°F (32°C) Hardwood Floor = 85°F (29°C)</p>	<p>FLOOR MAX</p>
<p>Access Level: Installer</p>	<p>Range: 40 to 122°F (4.5 to 50.0°C), OFF</p>
<p>Conditions: Sensor 1 or Sensor 2 set to Floor, and either Room Sensor set to ON, or Room Sensor set to OFF while Sensor 1 or 2 is set to Room, and Schedules or Scenes are in use.</p>	<p>Default: 85°F (29.5°C)</p>
<p><b>TEMPORARY HOLD</b></p> <p>Temperature adjustment in the home menu can result in either permanent temperature setting change or temporary temperature setting change that lasts 3, 6, 9, 12 hours or until the next scheduled event.</p>	<p>TEMPORARY HOLD</p>
<p>Access Level: Installer</p>	<p>Range: OFF or ON</p>
<p>Conditions: None</p>	<p>Default: OFF</p>



<b>Time Menu (1 of 2)</b>	
<b>Setting</b>	<b>Display</b>
<b>MINUTE</b> Select the current time minutes.	12:00
Access Level: Installer, User	Range: 00 to 59
Conditions: Schedule is used or Clock is set to ON.	Default: 00
<b>HOURS</b> Select the current time hours.	12:00
Access Level: Installer, User	Range: 12 AM to 11 PM or 00 to 23
Conditions: Schedule is used or Clock is set to ON.	Default: 12 AM
<b>DAY OF WEEK</b> Select the current day of the week.	SUNDAY
Access Level: Installer, User	Range: Sunday, Monday, Tuesday, Wednesday, Thursday, Friday, Saturday
Conditions: Schedule is used or Clock is set to ON.	Default: Sunday
<b>MONTH</b> Select the current month.	JANUARY 1
Access Level: Installer, User	Range: JANUARY to DECEMBER
Conditions: Schedule is used or Clock is set to ON.	Default: JANUARY
<b>DAY OF MONTH</b> Select the day of the current month.	JANUARY 1
Access Level: Installer, User	Range: 1 to 31
Conditions: Schedule is used or Clock is set to ON.	Default: 1
<b>YEAR</b> Select the current year.	20 13
Access Level: Installer, User	Range: 2014 to 2255
Conditions: Schedule is used or Clock is set to ON.	Default: 2014

## Time Menu (2 of 2)

Setting	Display
<b>DAYLIGHT SAVINGS TIME</b> Select if daylight savings time is observed.	<b>DAYLIGHT</b> SAVE
Access Level: Installer, User	Range: OFF or ON
Conditions: Clock setting is set to ON.	Default: ON
<b>TIME MODE</b> Select either 12 or 24 hour time format.	<b>TIME MODE</b>
Access Level: Installer, User	Range: 12 or 24 hour
Conditions: Clock setting is set to ON.	Default: 12 hour
<b>CLOCK</b> Select whether or not to show the time clock on the display.	<b>CLOCK</b>
Access Level: Installer, User	Range: OFF or ON
Conditions: The time is always shown when a schedule is used and the clock setting option is no longer available.	Default: OFF

## Schedule Menu (1 of 2)

The schedule menu can operate on a 24 hour or 7 day repeating schedule. When a 24 hour schedule is selected, "SuMoTuWeThFrSa" is shown on the top of the screen to show that the event time applies to all days of the week. When a 7 day schedule is selected, each individual day of the week is shown with the event time.

Setting	Display
<b>EVENT 1</b> The first programmable schedule time period of the day. The ☼ temperature settings are used during this time period.	SuMoTuWeThFrSa EVENT 1 ☼
Access Level: Installer, User	Range: 12:00 AM to 11:50 PM, SKIP or 00:00 to 23:50, SKIP
Conditions: Schedule setting is set to Zone or Master 1, 2, 3, 4 and Event/Day is set to 2 or 4.	Default: 6:00 AM
<b>EVENT 2</b> The second programmable schedule time period of the day. The ☾ temperature settings are used during this time period.	SuMoTuWeThFrSa EVENT 2 ☾
Access Level: Installer, User	Range: 12:00 AM to 11:50 PM, SKIP or 00:00 to 23:50, SKIP
Conditions: Schedule setting is set to Zone or Master 1, 2, 3, 4 and Event/Day is set to 2 or 4.	Default: 10:00 PM when Event/Day is 2 8:00 AM when Event/Day is 4
<b>EVENT 3</b> The third programmable schedule time period of the day. The ☼ temperature settings are used during this time period.	SuMoTuWeThFrSa EVENT 3 ☼
Access Level: Installer, User	Range: 12:00 AM to 11:50 PM, SKIP or 00:00 to 23:50, SKIP
Conditions: Schedule setting is set to Zone or Master 1, 2, 3, 4 and Event/Day is set to 4.	Default: 6:00 PM
<b>EVENT 4</b> The fourth programmable schedule time period of the day. The ☾ temperature settings are used during this time period.	SuMoTuWeThFrSa EVENT 4 ☾
Access Level: Installer, User	Range: 12:00 AM to 11:50 PM, SKIP or 00:00 to 23:50, SKIP
Conditions: Schedule setting is set to Zone or Master 1, 2, 3, 4 and Event/Day is set to 4.	Default: 10:00 PM

## Schedule Menu (2 of 2)

Setting	Display
<p><b>SCHEDULE</b></p> <p>Select if the thermostat should change the temperature automatically using a programmable schedule.            OFF = Programmable schedule is not used.            Zone = Applies to this thermostat only.            Master 1, 2, 3, 4 = In charge of one of four available network schedules.            Member 1, 2, 3, 4 = Follows selected network schedule.</p>	SCHEDULE
Access Level: Installer, User	Range: OFF, Zone, Master 1, 2, 3, 4, Member 1, 2, 3, 4
Conditions: In a tekmarNet® system, settings adjustable in Installer access level only.	Default: OFF
<p><b>EVENT PER DAY</b></p> <p>Select the number of temperatures per day.</p>	EVENT / DAY
Access Level: Installer, User	Range: 2 or 4
Conditions: Schedule setting is set to Zone or Master 1, 2, 3, 4.	Default: 2
<p><b>24 HOUR / 7 DAY</b></p>	24hr / 7DAY
Access Level: Installer, User	Range: 24 hour or 7 day
Conditions: Schedule setting is set to Zone or Master 1, 2, 3, 4.	Default: 24 hour
<p><b>OPTIMUM START</b></p> <p>Select whether or not to use optimum start. The thermostat learns the heat up rate of the radiant floor heating system and starts heating in advance of Event 1 or Event 3.</p>	OPTIMUM START
Access Level: Installer, User	Range: OFF or ON
Conditions: A schedule must be in use.	Default: ON

## Display Menu (1 of 2)

Setting	Display
<p><b>UNITS</b></p> <p>Select Fahrenheit or Celsius as the temperature units.</p>	UNITS IN
Access Level: Installer, User	Range: °F or °C
Conditions: Always available.	Default: °F

Display Menu (2 of 2)	
Setting	Display
<b>BACKLIGHT</b> Select how the display backlight operates. ON = Always full brightness. DIM = Dim when inactive, on when touched. DIM ☼ = Dim in ☼, off in ☾. On when touched. ON ☼ = On in ☼, off in ☾. On when touched. OFF = Always off.	<b>BACKLIGHT</b>
Access Level: Installer, User	Range: DIM, ON, DIM ☼, ON ☼, OFF
Conditions: Always available.	Default: DIM ☼
<b>SECONDARY ITEM</b> Determine the default item in the upper right hand corner of the display.	<b>SECONDARY ITEM</b>
Access Level: Installer, User	Range: NONE, OUT (outdoor), FLOR (floor)
Conditions: Always available.	Default: OUT (outdoor)

Scenes Menu (1 of 1)	
Setting	Display
<b>SCENES</b> Enable or disable the use of scenes (building overrides) on this thermostat.	<b>SCENES</b>
Access Level: Installer, User	Range: NONE, AWAY, ALL, GUEST
Conditions: Settings ALL and GUEST only available in Installer access level.	Default: NONE
<b>SCENE 4</b> Select how the thermostat should respond to scene 4.	<b>SCENE 4</b>
Access Level: Installer	Range: SCHD, ☼, ☾, Away
Conditions: Requires that Schedule is set to Zone, Master or Member 1, 2, 3, 4 and Scenes is set to All.	Default: SCHD (Schedule)
<b>AWAY KEY</b> Enable or disable the away touch key on the home screen.	<b>AWAY KEY</b>
Access Level: Installer, User	Range: OFF or ON
Conditions: Scene is set to ALL, AWAY, or GUEST.	Default: OFF
<b>LOCAL NETWORK GROUP</b> Select if scenes and time clock are shared when connected to a tekmarNet® system. OFF = Send and receive messages. ON = Receive messages only.	<b>LOCAL NET GROUP</b>
Access Level: Installer	Range: OFF or ON
Conditions: Always available.	Default: OFF

<b>Monitor Menu (1 of 3)</b>	
<b>Setting</b>	<b>Display</b>
<b>ROOM AVERAGE</b> Current room temperature. Displays the average if there are multiple room sensors.	<b>ROOM AVG</b>
Access Level: Installer	Range: -58 to 212°F (-50.0 to 100.0°C)
Conditions: Sensor 1 or 2 is set to Room.	Default: Not applicable.
<b>FLOOR AVERAGE</b> Current floor temperature. Displays the average if there are multiple floor sensors.	<b>FLOOR AVG</b>
Access Level: Installer	Range: -58 to 212°F (-50.0 to 100.0°C)
Conditions: Sensor 1 or 2 is set to Floor.	Default: Not applicable.
<b>W1 SUPPLY</b> First stage heating supply water temperature.	<b>W1 SUPPLY</b>
Access Level: Installer	Range: -22 to 266°F (-30.0 to 130.0°C)
Conditions: Setup menu setting W1 TERM set to CTRL, HRF1, HRF2, CONV or COIL.	Default: Not applicable.
<b>ROOM LOCAL</b> The built-in room sensor temperature measurement.	<b>ROOM LOCAL</b>
Access Level: Installer	Range: -58 to 212°F (-50.0 to 100.0°C)
Conditions: Setup menu setting ROOM SENSOR is set to ON.	Default: Not applicable.
<b>SENSOR 1</b> The temperature measurement from the sensor 1 input wiring terminals.	<b>SENSOR--1</b>
Access Level: Installer	Range: -22 to 266°F (-30.0 to 130.0°C)
Conditions: Setup menu setting SENSOR 1 is set to ROOM, FLOR, or OUT.	Default: Not applicable.
<b>SENSOR 2</b> The temperature measurement from the sensor 2 input wiring terminals.	<b>SENSOR--2</b>
Access Level: Installer	Range: -22 to 266°F (-30.0 to 130.0°C)
Conditions: Setup menu setting SENSOR 2 is set to ROOM or FLOR.	Default: Not applicable.

<b>Monitor Menu (2 of 3)</b>	
<b>Setting</b>	<b>Display</b>
<p><b>OUTDOOR HIGH</b> The highest recorded outdoor air temperature measurement. Touch the number and touch the ENTER key to reset.</p>	<p><b>OUT DOOR</b> HIGH</p>
Access Level: Installer, User	Range: -76 to 149°F (-60.0 to 65.0°C)
Conditions: Setup menu setting SENSOR 1 is set to Outdoor or an outdoor temperature is available on the tekmarNet® System.	Default: Not applicable.
<p><b>OUTDOOR LOW</b> The lowest recorded outdoor air temperature measurement. Touch the number and touch the ENTER key to reset.</p>	<p><b>OUT DOOR</b> LOW</p>
Access Level: Installer, User	Range: -76 to 149°F (-60.0 to 65.0°C)
Conditions: Setup menu setting SENSOR 1 is set to Outdoor or an outdoor temperature is available on the tekmarNet® System.	Default: Not applicable.
<p><b>ROOM HIGH</b> The highest recorded room temperature measurement. Touch the number and touch the ENTER key to reset.</p>	<p><b>ROOM</b> HIGH</p>
Access Level: Installer, User	Range: -76 to 149°F (-60.0 to 65.0°C)
Conditions: Setup setting ROOM SENSOR is set to ON or SENSOR 1 or 2 is set to ROOM.	Default: Not applicable.
<p><b>ROOM LOW</b> The lowest recorded room temperature measurement. Touch the number and touch the ENTER key to reset.</p>	<p><b>ROOM</b> LOW</p>
Access Level: Installer, User	Range: -76 to 149°F (-60.0 to 65.0°C)
Conditions: Setup setting ROOM SENSOR is set to ON or SENSOR 1 or 2 is set to ROOM.	Default: Not applicable.
<p><b>FLOOR HIGH</b> The highest recorded floor temperature measurement. Touch the number and touch the ENTER key to reset.</p>	<p><b>FLOOR</b> HIGH</p>
Access Level: Installer, User	Range: -76 to 149°F (-60.0 to 65.0°C)
Conditions: Setup menu setting SENSOR 1 or 2 is set to FLOR.	Range: Not applicable.

## Monitor Menu (3 of 3)

Setting	Display
<p><b>FLOOR LOW</b></p> <p>The lowest recorded floor temperature measurement. Touch the number and touch the ENTER key to reset.</p>	<p><b>FLOOR</b> LOW</p>
<p>Access Level: Installer, User</p>	<p>Range: -76 to 149°F (-60.0 to 65.0°C)</p>
<p>Conditions: Setup menu setting SENSOR 1 or 2 is set to FLOR.</p>	<p>Default: Not applicable.</p>
<p><b>HEAT W1</b></p> <p>The total number of hours the W1 relay has been operated for heating. Touch the number and touch the ENTER key to reset.</p>	<p><b>HEAT W1</b> HOUR</p>
<p>Access Level: Installer, User</p>	<p>Range: 0000 to 9999 hours</p>
<p>Conditions: Always available.</p>	<p>Default: 0000 hours</p>

## Toolbox Menu (1 of 3)

Setting	Display
<p><b>ACCESS LEVEL</b></p> <p>Selects the access level of the thermostat, which determines which menus and items are available.</p>	<p><b>ACCESS</b></p>
<p>Access Level: Installer, User, Limited, Secure</p>	<p>Range: INST (installer), USER, LTD (limited), SEC (secure)</p>
<p>Conditions: Adjustable only when thermostat switch setting set to UNLOCK OR tekmarNet® system control switch setting set to UNLOCK.</p>	<p>Default: INST</p>



## Toolbox Menu (2 of 3)

Setting	Display
<b>STATUS INFO</b> Displays the current status of the thermostat including any overrides from the tekmarNet® system control. Toggles between “Status Info” and the current status.	<b>STATUS</b> INFO
Override W1 = The tekmarNet® system control is either forcing the W1 relay on or off.	<b>OVERRIDE</b> W1
WWSD = Warm Weather Shut Down is in effect.	<b>WWSD</b>
Air Group Master Cool = Heating is off while the cooling system is on.	<b>AIR GROUP</b> MASTER
Optimum Start = Heating is started early in order to meet ✱ temperature setpoint at Event 1 or Event 3.	<b>OPTIMUM</b> START
Floor Max = The floor has reached its maximum temperature. Some under heating could occur.	<b>FLOOR MAX</b>
Floor Min = The floor is operating at its minimum temperature. Some over heating could occur.	<b>FLOOR MIN</b>
Baseload On = Baseload heating is on even though the room temperature is satisfied. Reduces heat up time when the sun sets in the evening.	<b>BASELOAD</b> EIN
System Normal = Thermostat is operating normally.	<b>SYSTEM</b> NORMAL
Access Level: Installer, User	Range: See Description
Conditions: Always available.	Default: System Normal
<b>ADDRESS</b> The tekmarNet® address of this thermostat. AUTO = Automatic addressing To manually set the address, use the up or down arrow buttons while in the Installer access level.	<b>ADDRESS</b>
Access Level: Installer	Range: AUTO, 01 to 24, b:01 to b:04, 1:01 to 1:24, 2:01 to 2:24, 3:01 to 3:24
Conditions: tekmarNet®2 or tekmarNet®4 communication detected.	Default: AUTO

## Toolbox Menu (3 of 3)

Setting	Display
<b>SOFTWARE AND TYPE VERSION</b> Displays the software version and the tekmar type number.	SW J 12 13A TYPE
Access Level: Installer, User, Limited, Secure	Range: 552
Conditions: Always available.	Default: 552
<b>DEVICE COUNT</b> Provides a count of all the tekmarNet® thermostats and setpoint controls on the tekmarNet® system.	DEV COUNT
Access Level: Installer	Range: 1 to 24
Conditions: Must be connected to a tekmarNet® system.	Default: 1
<b>USER TEST</b> Select to begin the test routine by touching the up arrow. Step 1: The W1 relay will turn on. Touch Cancel to stop test routine. Touch Hold to pause test routine at current step for 5 minutes.	USER TEST
Access Level: Installer	Range: OFF or ON
Conditions: Always available.	Default: OFF
<b>OFFSET ROOM</b> Manual offset correction of the room temperature measurement.	OFFSET ROOM
Access Level: Installer	Range: -5 to +5°F (-3.0 to +3.0°C)
Conditions: Always available.	Default: 0°F (0.0°C)
<b>LOAD FACTORY DEFAULTS</b> Touch Enter to load the factory defaults settings.	DEFAULTS LOAD?
Access Level: Installer	Range: None
Conditions: Always available.	Default: Keep existing settings
<b>ERROR HISTORY 1 THROUGH 5</b> Displays a history of the last 5 errors that have occurred on the thermostat in the past 30 days. Touch Enter to manually clear the error code.	HISTORY - 1
Access Level: Installer	Range: See Troubleshooting section
Conditions: An error must have occurred in order to view in the error history.	Default: Not applicable

Setup Menu (1 of 2)	
Setting	Display
<b>SENSOR 1</b> Select to the type of sensor connected to auxiliary sensor input 1.	<b>SENSOR 1</b>
Access Level: Installer	Range: OFF, ROOM, FLOR (floor), OUT (outdoor)
Conditions: Always available.	Default: OFF
<b>SENSOR 2</b> Select to the type of sensor connected to auxiliary sensor input 2.	<b>SENSOR 2</b>
Access Level: Installer	Range: OFF, ROOM, FLOR (floor)
Conditions: Always available.	Default: OFF
<b>ROOM SENSOR</b> Select whether the built-in room temperature sensor is on or off.	<b>ROOM</b> SENSOR
Access Level: Installer	Range: OFF or ON
Conditions: Only available when Sensor 1 or Sensor 2 is set to Room or Floor.	Default: ON
<b>W1 TERMINAL UNIT</b> Select the terminal unit type of the first stage of heat W1. CTRL = Same as on tekmarNet® system control. HRF1 = High mass hydronic radiant floor HRF2 = Low mass hydronic radiant floor CONV = Fin-tube convectors COIL = Fan coil OTHR = Other than hydronic heating	<b>W1 TERM</b>
Access Level: Installer	Range: CTRL, HRF1, HRF2, CONV, COIL, OTHR
Conditions: Only available when a tekmarNet® system control is connected.	Default: CTRL
<b>W1 PUMP</b> Select whether the primary or mix system pump on a tekmarNet® system control should operate while the first stage of heat W1 is operating.	<b>W1 PUMP</b>
Access Level: Installer	Range: OFF or ON
Conditions: Only available when a tekmarNet® system control is connected and the Setup menu setting W1 TERM is set to CTRL, HRF1, HRF2, CONV, or COIL.	Default: ON

## Setup Menu (2 of 2)

Setting	Display
<p><b>W1 THERMAL MOTOR</b></p> <p>Select whether the first stage of heat W1 operates a thermally actuated zone valve (wax actuator). When set to ON, there is a 3 minute delay before operating the pump and any heat sources.</p>	<p>W1 THERM MOTOR</p>
Access Level: Installer	Range: OFF or ON
Conditions: Setup menu setting W1 TERM is set to CTRL, HRF1, HRF2, CONV, or COIL.	Default: OFF
<p><b>W CYCLES PER HOUR</b></p> <p>Select the number of heating cycles per hour.            SYNC = Synchronize thermostats to a 20 minute cycle.            AUTO = Automatic cycles per hour to minimum temperature swings.</p>	<p>W CYCLES/ HOUR</p>
Access Level: Installer	Range: SYNC, AUTO, 2 to 12
Conditions: Setup menu setting W1 TERM is set to OTHR (other) or the thermostat is not connected to a tekmarNet® system control.	Default: SYNC
<p><b>BASELOAD</b></p> <p>Select the level of radiant floor baseload heating. This warms the floor so that solar gain and / or air heating systems do not cause cold floors.</p>	<p>BASELOAD</p>
Access Level: Installer	Range: OFF, LOW, MED, HIGH
Conditions: Only available when a tekmarNet® system control is connected and the Setup menu setting W1 TERM is set to HRF1 or HRF2 and SENSOR 1 or 2 is not set to FLOR (floor).	Default: OFF
<p><b>AIR GROUP MEMBER</b></p> <p>Select if the thermostat is a member of an air group or cooling group.</p>	<p>AIR GROUP MEMBER</p>
Access Level: Installer	Range: NONE, 1 to 16
Conditions: The thermostat must be connected to other thermostats using tekmarNet®.	Default: NONE

# Sequence of Operation

## Heating Operation

## Section A

### Set Heat Temperature

When using only a room temperature sensor, the thermostat operates the heating system to maintain the Set Heat Room temperature.

When using only a floor temperature sensor, the thermostat operates the heating system to maintain the Set Heat Floor temperature. In this case, the thermostat does not try to control the air temperature. This is ideal for bathrooms and some kitchen applications where the customer wants their feet to feel warm on the floor. This is also ideal for garages so that the heating system is not affected by the opening of the garage door in cold outdoor weather.

When using both a room and a floor temperature sensor, the thermostat always maintains the Floor Minimum temperature, even when the air temperature is satisfied. When the air temperature is below the Set Heat Room temperature, the thermostat operates the heating system to maintain the Set Heat Room temperature. The floor is never heated above the Floor Maximum setting in order to protect the floor covering. Suggested Floor Maximum settings are 90°F (32°C) for tile, stone, or concrete floors and 85°F (29°C) for wood floors.

The “Heat On” symbol is shown on the display when the thermostat is heating.

### Room Minimum and Maximum

Room Minimum and Maximum temperature settings are available in the Set Temp menu. These allow the installer to select start and stop limits for the temperature setting for the User and Limited access levels. This is useful in commercial installations and child / guest bedrooms where availability of the full temperature setting range may not be desirable.

### Warm Weather Shut Down

When the outdoor air temperature exceeds the Warm Weather Shut Down (WWSD) setting on the tekmarNet® main control, the heating system is shut off.

### Radiant Floor Baseload

When the terminal unit is selected to be a Hydronic Radiant Floor (HRF1 or HRF2) and no floor temperature sensor is installed, the thermostat has option to provide baseload heating. This allows the radiant floor to be heated even though the room air temperature is satisfied. This is useful in areas where a radiant floor heating zone is overlapped by an air heating system. The radiant floor heating is overwhelmed by the quick heat up rate of the air heating system, resulting in a radiant floor heating zone that rarely turns on. The radiant baseload option allows the radiant floor to counteract the air heating system by heating the floor at a reduced output even when the room air temperature is satisfied. This is also useful in areas that experience large solar gains through windows. The radiant baseload is automatically shut off in the summer by the warm weather shut down feature.

## Freeze Protection

---

The thermostat operates the heat whenever the room or floor temperature falls below 40°F (4.5°C) even when the mode is set to off.

## Exercising

---

When connected to a tekmarNet® system control, the thermostat exercises the heat relay for 10 seconds every 3 days. Exercising helps prevent zone valves or zone pumps from failing due to precipitate buildup. During exercising, the thermostat shows “TEST” on the display.

## Flushing

---

The flushing feature is for open-loop systems that use a domestic hot water tank as a heat source. Flushing ensures that fresh potable water is circulated through the system once each day. If the thermostat is connected to a tekmarNet® system control with the Flushing feature turned on, the thermostat display will display “FLUSHING” for the duration of the flushing operation.

## Hydronic System Supply Pump

---

When connected to a tekmarNet® system control, the thermostat's W1 Pump setting affects how the primary pump or mix pump on the system control operates. When connected to the boiler bus, the boiler system or primary pump is operated. When connected to the mix bus, the mix system pump is operated.

If the thermostat operates a motorized or thermal motor zone valve, the W1 Pump setting should be set to On.

If the thermostat operates a thermal motor (wax actuator) zone valve, set the W1 Thermal Motor setting to On. This provides a three minute delay to allow the zone valve to open before the primary or mix pump is turned on.

In special applications with multiple zoning manifolds, the W1 Pump setting can be set to Off. This allows a Zone Group Pump located on the Zone Manager, or Wiring Center to operate the pump for the manifold.

## DHW Tank Priority

---

When a tekmarNet® system control is heating an indirect Domestic Hot Water (DHW) tank, the thermostat may shut off the heating zones to allow the DHW tank to recover quickly. This is determined by the DHW priority of the tekmarNet® system control.

In order to prevent heating and cooling at the same time, this thermostat can operate together with other thermostats on a tekmarNet® system to form an air group. On older model thermostats the air group functionality was previously described as a cool group.

In an air group, one thermostat is assigned as the air group master. The air group master operates the cooling equipment for the group. This thermostat can be set to be a member of the air group.

When operating as a air group, the air temperature readings of all the air group member thermostats are communicated to the air group master thermostat and an average temperature is determined.

When the air group master is in cooling operation, the air group member thermostats do not operate the heating system for air heating.

If the Set Heat Room temperature is adjusted while the air group is cooling, COOL is flashed on the display to alert the user that the air group cooling system is presently on and heating is not available. Once the cooling system shuts off, heating is available if required.

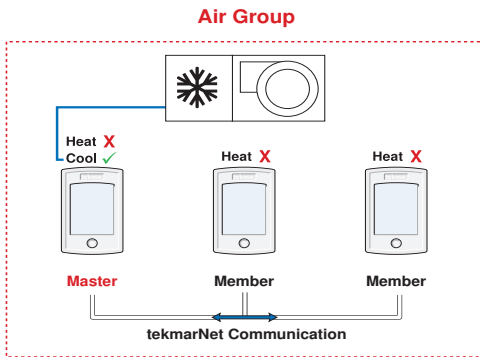

The thermostat includes a time clock that is automatically visible in the Home menu when a programmable schedule is used. If the schedule is not used, the user has the option to select whether the time is shown in the Home menu.

**During a loss of power, the thermostat continues to keep the correct time and date for at least 4 hours.** If the power is off for more than 4 hours, the user will need to set the time.

The thermostat supports automatic update for daylight savings time. Simply set Daylight Save to On together with the correct day, month, and year and the time is automatically updated each spring and fall.

When connected to a tekmarNet® system, adjustment of the time on one thermostat updates all connected thermostats. This option can be disabled by selecting the Local Network Group setting to be On.

**Permanent Adjustment - No Schedule**

When no programmable schedule is used, touch the up or down arrows to permanently set the “Set Heat” temperature. This thermostat is capable of controlling the air or floor temperature. When set to control the floor temperature alone, the display will show “Floor” instead of “Room”.

**Permanent Adjustment - With Schedule**

When a programmable schedule is used, there are two room heating temperatures available, one for the ☀ time period and another for the ☾ time period. When touching the up or down arrows to change the temperature, only the temperature for the current time period is changed.

1. To adjust the temperature for both time periods, press and hold the Home button for 3 seconds to enter the programming menu.
2. Enter the “SET TEMP” menu to adjust the following settings:
  - Set Heat Room ☀ (air heating or air heating with floor sensor)
  - Set Heat Room ☾ (air heating or air heating with floor sensor)
  - Set Heat Room AWAY (air heating or air heating with floor sensor)
  - Floor Min ☀ (air heating with floor sensor)
  - Floor Min ☾ (air heating with floor sensor)
  - Set Heat Floor ☀ (floor heating sensor only)
  - Set Heat Floor ☾ (floor heating sensor only)

**Temporary Hold**

Temporary hold allows a user to change the temperature for a period of time and then automatically return to the permanent temperature setting. This is especially useful in commercial buildings that are in use for short amounts of time. When selected, touching the up or down arrows changes the temperature for either 3, 6, 9 or 12 hours. If the thermostat is using a schedule, ‘Schd’ provides a temporary hold until the next schedule event time. After the temporary hold time expires, the thermostat returns to normal operation. By default, the temporary hold feature is off.



When the temporary hold feature is enabled, touching the up or down arrow displays ‘TEMPORARY HOLD’.

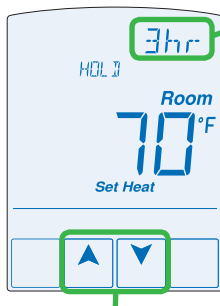

Use the Up or Down arrow to select a temperature.

Tap the hour setting until the preferred length of time is displayed.

Cancel the temporary hold.

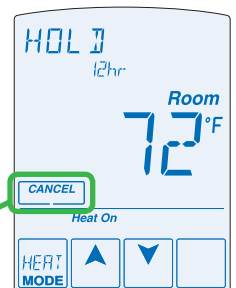

‘HOLD’ is displayed while the thermostat is operating at the temporary hold temperature.



Lowering the room temperature setting reduces the amount of fuel required to heat the building resulting in energy savings.

When operating on a programmable schedule, a ☀ or a ☾ symbol is shown in the home menu. The ☀ or ☾ indicates the current operating temperature.

**All schedules are stored in permanent memory and are not affected by a loss of power.**

Display	Action
☀	Day temperature
☾	Night temperature

This thermostat can operate on a programmable schedule in order to automatically lower the room temperature setting. Options include:

- Turning off the schedule (OFF)
- Operate a schedule that applies only to this thermostat zone (ZONE)
- The ability to operate one of the four system-wide schedules as a master (Schedule Master 1 through 4\*)
- Join one of the four system-wide schedules as a member (Schedule Member 1 though 4\*)

\*Requires the thermostat to be connected to a tekmarNet® system.

Once the type of schedule has been selected, the thermostat can support schedules that have either:

- 2 events per day
- 4 events per day

Schedules with four events per day are common for residential use while two events per day are common for commercial installations.

The schedules can be repeated every:

- 24 hours
- 7 days (week)

A 7 day schedule allows a unique time to be set to change the temperature for each day of the week.

The schedule also includes a “SKIP” option that allows the programmable schedule to skip a temperature change and remain at the previous temperature setting. The “SKIP” setting can be found between 11:50 PM (23:50 hours) and 12:00 AM (0:00 hours).

When a programmable schedule is selected, there is a time delay for the room to warm up from the ☾ temperature to the ☀ temperature. The thermostat has the option to use Optimum Start to predict the heat up rate of the room. When Optimum Start is set to On, the heating is started in advance to allow the room to reach the Set Room ☀ temperature at the time set in the programmable schedule.

Scenes provide an easy way to save energy while away on vacation, or override a programmable schedule when plans change.

**Away Key**

This thermostat includes an Away Key to quickly turn down the heating temperature on all thermostats and suspend heating the domestic hot water tank to maximize energy savings. To turn on the Away Key, go to the Scene menu.

To activate the Away scene, touch “Going Away” on the screen.

- Select PERM (permanent) or a number of days using the ▲ or ▼ arrow. Range is 1 to 180 days.
- Press the home button to accept the setting or leave the screen untouched for several seconds.
- “Scene Away” is displayed on the home screen until the number of days expires.
- Touch “Cancel Away” to cancel at any time.



**The temperature is not adjustable while the thermostat is in Away.**

**Additional Scenes**

Additional energy saving scenes are available when a User Switch or Gateway is installed. A complete listing of each scene is shown below.

Scene Number	Scenes = None Operation	Scenes = Away Operation	Scenes = All Operation	Scenes = Guest Operation
1	Permanent ✨ or Schedule	Permanent ✨ or Schedule	Permanent ✨ or Schedule	Permanent ☾
2	Scene 1	Away	Away	Away
3	Scene 1	Scene 1	Permanent ☾	Permanent ☾
4	Scene 1	Scene 1	Configurable	Permanent ☾
5	Scene 1	Scene 1	Permanent ✨ or Schedule	Permanent ✨ or Schedule
6	Scene 1	Scene 1	Temporary ✨ 3 Hours	Permanent ☾
7	Scene 1	Scene 1	Temporary ☾ 4 Hours	Permanent ☾
8	Scene 1	Scene 1	Temporary ✨ 8 Hours	Permanent ☾

## Recommendation on How to Use Scenes

Choosing how to use scenes depends on the needs and lifestyle of the customer using the building.

### Multi-Tenant Apartments

Scenes should be disabled (None) in multi-tenant buildings where the each occupant has differing heating requirements.

### Residential Homes

Some residential customers may not require scenes, in which case, scenes can be disabled (None). Home owners that wish to save on energy costs should consider using the Away scene to save energy while away from the property (example: vacation or holidays).

The use of the Guest scene is useful in residential applications where there are a number of spare bedrooms that are occupied on an infrequent basis. Each spare bedroom would be setup to operate on the Guest scene. The remaining thermostats can be setup to operate on the None, Away or All scene configuration. Normally, the spare bedrooms would operate at the moon temperature settings. When guests arrive, scene 5 can be activated through the use a User Switch or Gateway. The spare bedroom then operates at the ☼ temperature settings or operates on a programmable schedule if a schedule has been setup. When guests depart, the scene can be changed back to scene 1 and the spare bedrooms resume operation at the ☾ temperature settings.

### Commercial Buildings

Commercial buildings are typically in use on a predictable schedule and normally the building can operate in scene 1. In order to accommodate staff working overtime or cleaning staff, a 3 or 8 hour temporary override is available when installed in conjunction with a User Switch or Gateway. In these cases, the thermostats should be setup to use the All scene configuration. At the touch of a button, the whole building changes from operating on a programmable schedule (typically at the ☾ temperature setting when not occupied) to operating at the ☼ temperature settings for 3 hours (scene 6) or 8 hours (scene 8). After the timer counts down and expires, the scene changes back the previous scene.

## Secondary Temperature Display

## Section H

This thermostat can display the outdoor or floor temperature in the upper right hand corner of the display. Touch the upper right hand corner to toggle the item currently displayed. Display of the floor or outdoor temperature requires a connection to an outdoor or floor temperature sensor, or the thermostat is connected to a tekmarNet® system that includes an outdoor sensor. The reading of the outdoor sensor connected directly to the thermostat takes precedence over any outdoor sensor reading available on the tekmarNet® system.

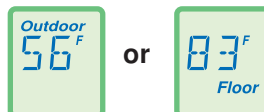

The thermostat Toolbox menu supports four access levels: Installer (INST), User (USER), Limited (LTD), and Secure (SEC). The access level can be adjusted when the thermostat is unlocked. There are two locations to lock the thermostat:

- 1) Locally on the back of the thermostat using the Lock switch
- 2) Globally on the tekmarNet® system control using the Lock switch or Access level (if installed)

Both the local and global lock settings must be set to unlock before the thermostat access level is adjustable.

The selection of the access level is dependent on the use of the building and the type of occupants.

**Installer** - Suitable for HVAC installers only. Times out to User access level after 24 hours.

**User** - Suitable for most residential homeowners.

**Limited** - Suitable for rental properties or commercial buildings where some level of temperature adjustment is required.

**Secure** - Suitable for schools, churches, and other public buildings where temperature adjustment is not desired.

When connected to a tekmarNet® system, each thermostat will be automatically given an address. The address is useful as a troubleshooting tool to locate thermostats with errors and also allows room naming on a Gateway.

The address consists of the bus water temperature followed by the thermostat device number. Available buses are b (boiler), 1, 2 and 3. Device numbers range from 01 to 24. If the thermostat is used without a tekmarNet® system control, the bus number is not shown.

When using the thermostat together with a Gateway, it is important that each address be changed to be manually set. This allows each thermostat to be named on the Gateway.







If two thermostats are manually set to the same address, an error message will appear. The error remains until one of the addresses is manually changed to a vacant address or to Auto.

It is highly recommended to keep a documented list of thermostat addresses. This is extremely helpful when troubleshooting errors. The tekmarNet® system control will display the addresses of thermostat's that have errors. By referring to the address documentation, it simplifies the process to locate and correct error messages.

Entering the Screen Clean menu gives you 30 seconds to clean the thermostat and display with a moist cloth. Do not use solvents to clean the thermostat.

# Troubleshooting

## Error Messages (1 of 5)

Error Message	Description
 <p>SETUP SAVE ERR</p>	<b>SETUP MENU SAVE ERROR</b> The thermostat failed to read the Setup menu settings from memory and has reloaded the factory default settings. The thermostat stops normal operation until all settings in the Setup menu are checked except to provide freeze protection. To clear the error, set the access level to Installer and check all settings in the Setup menu.
 <p>SET TEMP SAVE ERR</p>	<b>SET TEMP MENU SAVE ERROR</b> The thermostat failed to read the Set Temp menu settings from memory and has reloaded the factory default settings. The thermostat stops normal operation until all settings in the Set Temp menu are checked except to provide freeze protection. To clear the error, set the access level to Installer and check all settings in the Set Temp menu.
 <p>MONITOR SAVE ERR</p>	<b>MONITOR MENU SAVE ERROR</b> The thermostat failed to read the Monitor menu settings from memory and has reloaded the factory default settings. The thermostat continues to operate normally while displaying this error. To clear the error, set the access level to Installer and check all settings in the Monitor menu.
 <p>SCHEDULE SAVE ERR</p>	<b>SCHEDULE MENU SAVE ERROR</b> The thermostat failed to read the Schedule menu settings from memory and has reloaded the factory default settings. The thermostat continues to operate normally while displaying this error. To clear the error, set the access level to Installer and check all settings in the Schedule menu.
 <p>TOOLBOX SAVE ERR</p>	<b>TOOLBOX MENU SAVE ERROR</b> The thermostat failed to read the Toolbox menu settings from memory and has reloaded the factory default settings. The thermostat continues to operate normally while displaying this error. To clear the error, set the access level to Installer and check all settings in the Toolbox menu.
 <p>TIME SAVE ERR</p>	<b>TIME MENU SAVE ERROR</b> The thermostat failed to read the Time menu settings from memory and has reloaded the factory default settings. The thermostat continues to operate normally while displaying this error. To clear the error, set the access level to Installer and check all settings in the Time menu.





## Error Messages (2 of 5)

Error Message	Description
<p>SCENES SAVE ERR</p>	<p><b>SCENES MENU SAVE ERROR</b></p> <p>The thermostat failed to read the Scenes menu settings from memory and has reloaded the factory default settings. The thermostat continues to operate normally while displaying this error.</p> <p>To clear the error, set the access level to Installer and check all settings in the Scenes menu.</p>
<p>DISPLAY SAVE ERR</p>	<p><b>DISPLAY MENU SAVE ERROR</b></p> <p>The thermostat failed to read the Display menu settings from memory and has reloaded the factory default settings. The thermostat continues to operate normally while displaying this error.</p> <p>To clear the error, set the access level to Installer and check all settings in the Display menu.</p>
<p>tN2 PORT ERR</p>	<p><b>tN2 PORT ERROR</b></p> <p>The thermostat has been connected to a tN2 zone already in use by a 2-stage zoning control. A 2-stage device requires two tN2 ports to operate. This device may be connected to one such port.</p> <p>To clear the error, move the thermostat's tN2 wires to an unused tN2 port on the zoning control.</p>
<p>TEKMARNET COM ERR</p>	<p><b>tekmarNet® COMMUNICATION ERROR</b></p> <p>The tekmarNet® communication bus has either an open or a short circuit. The result is that there are no communications. Check for loose wires between tN4 and C. Check for short circuits between the tN4 and C wires on the House Control, Wiring Center, or Zone Manager. Check for correct polarity between the C and R wires.</p> <p>The error clears automatically once the wiring fault has been corrected.</p> <p>To force the error to clear while allowing a short or open circuit to continue, touch the Cancel key.</p>
<p>ADDRESS TAKEN ERR</p>	<p><b>ADDRESS ERROR</b></p> <p>Two thermostats have been manually set to the same address. The thermostat continues to operate with this error but does not communicate with the tekmarNet® system.</p> <p>To clear this error, select an unused tekmarNet® address or select automatic addressing.</p>
<p>DEVICE LIMIT ERR</p>	<p><b>DEVICE LIMIT</b></p> <p>More than 24 devices (thermostats or setpoint controls) have been connected to the tekmarNet® communication bus. To clear the error, remove and relocate devices to other available buses until the device count is 24 or less.</p>

## Error Messages (3 of 5)

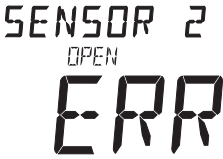
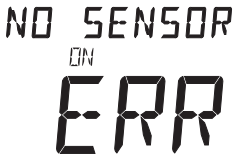
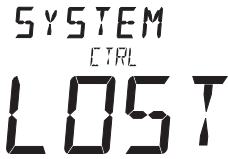
Error Message	Description
<p>ROOM SHORT ERR</p>	<p><b>ROOM SENSOR SHORT CIRCUIT ERROR</b></p> <p>Due to a short circuit, the thermostat is unable to read the built-in room temperature sensor. If Sensor 1 or 2 is set to Room, or the thermostat is connected to a tekmarNet<sup>®</sup> system control, the thermostat continues to operate, otherwise operation stops.</p> <p>The error cannot be field repaired. Contact your tekmar<sup>®</sup> sales representative for repair procedures.</p>
<p>ROOM OPEN ERR</p>	<p><b>ROOM SENSOR OPEN CIRCUIT ERROR</b></p> <p>Due to an open circuit, the thermostat is unable to read the built-in room temperature sensor. If Sensor 1 or 2 is set to Room, or the thermostat is connected to a tekmarNet<sup>®</sup> system control, the thermostat continues to operate, otherwise operation stops.</p> <p>The error cannot be field repaired. Contact your tekmar<sup>®</sup> sales representative for repair procedures.</p>
<p>SENSOR 1 SHORT ERR</p>	<p><b>SENSOR 1 SHORT CIRCUIT ERROR</b></p> <p>Due to a short circuit, the thermostat is unable to read auxiliary Sensor 1. The thermostat stops normal operation if Sensor 1 is the only active Room or Floor sensor or if a Floor Maximum temperature has been set.</p> <p>Check the auxiliary sensor wire for short circuits according to the sensor installation manual. It may be necessary to replace the auxiliary sensor. Once the error has been corrected, the error message automatically clears.</p>
<p>SENSOR 1 OPEN ERR</p>	<p><b>SENSOR 1 OPEN CIRCUIT ERROR</b></p> <p>Due to an open circuit, the thermostat is unable to read auxiliary Sensor 1. The thermostat stops normal operation if Sensor 1 is the only active Room or Floor sensor or if a Floor Maximum temperature has been set.</p> <p>Check the auxiliary sensor wire for short circuits according to the sensor installation manual. It may be necessary to replace the auxiliary sensor. Once the error has been corrected, the error message automatically clears.</p> <p>If the auxiliary sensor 1 has been intentionally removed, set the Sensor 1 setting in the Setup menu to Off.</p>
<p>SENSOR 2 SHORT ERR</p>	<p><b>SENSOR 2 SHORT CIRCUIT ERROR</b></p> <p>Due to a short circuit, the thermostat is unable to read auxiliary Sensor 2. The thermostat stops normal operation if Sensor 2 is the only active Room or Floor sensor or if a Floor Maximum temperature has been set.</p> <p>Check the auxiliary sensor wire for short circuits according to the sensor installation manual. It may be necessary to replace the auxiliary sensor. Once the error has been corrected, the error message automatically clears.</p>

## Error Messages (4 of 5)



Error Message	Description
	<b>SENSOR 2 OPEN CIRCUIT ERROR</b> Due to an open circuit, the thermostat is unable to read auxiliary Sensor 2. The thermostat stops normal operation if Sensor 2 is the only active Room or Floor sensor or if a Floor Maximum temperature has been set. Check the auxiliary sensor wire for short circuits according to the sensor installation manual. It may be necessary to replace the auxiliary sensor. Once the error has been corrected, the error message automatically clears. If the auxiliary sensor 2 has been intentionally removed, set the Sensor 2 setting in the Setup menu to Off.
	<b>NO SENSOR ON ERROR</b> All of the temperature sensors have been set to Off including the built-in room sensor. To clear the error, the Room Sensor, Sensor 1 or Sensor 2 must be set to measure a temperature.
	<b>SYSTEM CONTROL LOST ERROR</b> The thermostat can no longer communicate to the tekmarNet® system control. Check for open or short circuits in the tekmarNet® communication wiring. The error automatically clears once the tekmarNet® system control has been detected. If the tekmarNet® system control was intentionally removed from the system, remove and then re-apply power to the thermostat to clear the error.
	<b>AIR GROUP MEMBER ERROR</b> The thermostat can no longer detect its air group or cooling group master thermostat through the tekmarNet® system. To clear the error, either select a heat-cool thermostat to be the air group master or set this thermostat's air group member setting in the Setup menu to be set to None.
	<b>SCHEDULE MASTER ERROR</b> Two thermostats on the tekmarNet® system have been set to the same Schedule Master number. The thermostat operates at the ✱ temperature settings while this error is present. To clear the error, select a different Schedule Master number, set a different Schedule Member number, set the Schedule to Zone, or set the Schedule to None.
	<b>SCHEDULE MEMBER ERROR</b> The thermostat can not longer detect its schedule master. The thermostat operates at the ✱ temperature settings while this error is present. To clear the error, select a different Schedule Member number, set the Schedule to Zone, or set the Schedule to None.



## Error Messages (5 of 5)

Error Message	Description
<p>ERROR AT TSTAT 01</p>	<p><b>ERROR AT THERMOSTAT</b> There is an error on a different thermostat or setpoint control connected to the tekmarNet® system and not on this thermostat. 01 to 24 = There is an error on a thermostat or setpoint control with this tekmarNet® address.</p>
<p>ERROR AT TSTAT b:01</p>	<p><b>ERROR AT THERMOSTAT</b> There is an error on a different thermostat or setpoint control connected to the tekmarNet® system and not on this thermostat. b:01 to b:24 = There is an error on a thermostat or setpoint control wired to the boiler communication bus with this tekmarNet® address.</p>
<p>ERROR AT TSTAT 1:01</p>	<p><b>ERROR AT THERMOSTAT</b> There is an error on a different thermostat or setpoint control connected to the tekmarNet® system and not on this thermostat. 1:01 to 1:24 = There is an error on a thermostat or setpoint control wired to communication bus 1 with this tekmarNet® address.</p>
<p>ERROR AT TSTAT 2:01</p>	<p><b>ERROR AT THERMOSTAT</b> There is an error on a different thermostat or setpoint control connected to the tekmarNet® system and not on this thermostat. 2:01 to 2:24 = There is an error on a thermostat or setpoint control wired to communication bus 2 with this tekmarNet® address.</p>
<p>ERROR AT TSTAT 3:01</p>	<p><b>ERROR AT THERMOSTAT</b> There is an error on a different thermostat or setpoint control connected to the tekmarNet® system and not on this thermostat. 3:01 to 3:24 = There is an error on a thermostat or setpoint control wired to the mix 3 bus with this tekmarNet® address.</p>
<p>ERROR AT SYSTEM CTRL</p>	<p><b>ERROR AT SYSTEM CONTROL</b> There is an error on the tekmarNet® system control connected to the tekmarNet® system and not on this thermostat.</p>

## Frequently Asked Questions

Symptom	Look for...	Corrective Action
No heat	<i>Heat On</i>	<i>Heat On</i> indicates heat relay W1 is on. If the <i>Heat On</i> is displayed and there is no heat, check if the zone valve or zone pump is operating.
		The thermostat is in the Off mode. Touch the mode key to change to Heat.
No ▲ or ▼ keys	<i>SCENE AWAY</i>	Touch the 'Cancel Away' key on the display.
Heat on before scheduled time		Optimum Start "learns" the heat up and cool off rate of the room and starts the heating or cooling early so that the room is comfortable at the scheduled time.
Touching ▲ key does not increase temperature	Flashing <i>MAX</i>	The thermostat has reached the room maximum setting and cannot be adjusted any higher. If required, the room maximum setting can be adjusted in the Set Temp menu.
	Flashing <i>MAX FL</i>	The floor has reached the floor maximum setting. If required, floor maximum can be adjusted in the Set Temp menu.
	Flashing <i>WWSD</i>	Warm weather shut down is in effect. Increase WWSD if heat is necessary.
Touching ▼ key does not decrease temperature	Flashing <i>MIN</i>	The thermostat has reached the room minimum setting and cannot be adjusted any lower. If required, the room maximum setting can be adjusted in the Set Temp menu.

## Technical Data

### tekmarNet® Thermostat 552; *One Stage Heat*

Packaged weight	0.8 lb. (350 g)
Enclosure	White ABS / PC plastic
Dimensions	5" H x 3-1/4" W x 15/16" D (127 x 82 x 23 mm)
Approvals	Meets Class B: ICES & FCC Part 15
Ambient conditions	Indoor use only, 32 to 122°F (0 to 50°C), RH ≤90% non-condensing
Power supply	24 V ±10%, 50/60 Hz, 1.8 VA Standby, 56 VA fully loaded, NEC / CEC Class 2
W1 Relay	24 V (ac) 2 A
Sensors:	NTC thermistor, 10 kΩ @ 77°F (25°C ±0.2°C) β=3892
– Included	None
– Optional	tekmar type # 070, 071, 072, 073, 076, 077, 078, 079, 082, 084

## Limited Warranty and Product Return Procedure

**Limited Warranty** *The liability of tekmar under this warranty is limited. The Purchaser, by taking receipt of any tekmar product ("Product"), acknowledges the terms of the Limited Warranty in effect at the time of such Product sale and acknowledges that it has read and understands same.*

The tekmar Limited Warranty to the Purchaser on the Products sold hereunder is a manufacturer's pass-through warranty which the Purchaser is authorized to pass through to its customers. Under the Limited Warranty, each tekmar Product is warranted against defects in workmanship and materials if the Product is installed and used in compliance with tekmar's instructions, ordinary wear and tear excepted. The pass-through warranty period is for a period of twenty-four (24) months from the production date if the Product is not installed during that period, or twelve (12) months from the documented date of installation if installed within twenty-four (24) months from the production date.

The liability of tekmar under the Limited Warranty shall be limited to, at tekmar's sole discretion: the cost of parts and labor provided by tekmar to repair defects in materials and / or workmanship of the defective product; or to the exchange of the defective product for a warranty replacement product; or to the granting of credit limited to the original cost of the defective product, and such repair, exchange or credit shall be the sole remedy available from tekmar, and, without limiting the foregoing in any way, tekmar is not responsible, in contract, tort or strict product liability, for any other losses, costs, expenses, inconveniences, or damages, whether direct, indirect, special, secondary, incidental or consequential, arising from ownership or use of the product, or from defects in workmanship or materials, including any liability for fundamental breach of contract.

The pass-through Limited Warranty applies only to those defective Products returned to tekmar during the warranty period. This Limited Warranty does not cover the cost of the parts or labor to remove or transport the defective Product, or to reinstall the repaired or replacement Product, all such costs and expenses being subject to Purchaser's agreement and warranty with its customers.

Any representations or warranties about the Products made by Purchaser to its customers which are different from or in excess of the tekmar Limited Warranty are the Purchaser's sole responsibility and obligation. Purchaser shall indemnify and hold tekmar harmless from and against any and all claims, liabilities and damages of any kind or nature which arise out of or are related to any such representations or warranties by Purchaser to its customers.

The pass-through Limited Warranty does not apply if the returned Product has been damaged by negligence by persons other than tekmar, accident, fire, Act of God, abuse or misuse; or has been damaged by modifications, alterations or attachments made subsequent to purchase which have not been authorized by tekmar; or if the Product was not installed in compliance with tekmar's instructions and / or the local codes and ordinances; or if due to defective installation of the Product; or if the Product was not used in compliance with tekmar's instructions.

THIS WARRANTY IS IN LIEU OF ALL OTHER WARRANTIES, EXPRESS OR IMPLIED, WHICH THE GOVERNING LAW ALLOWS PARTIES TO CONTRACTUALLY EXCLUDE, INCLUDING, WITHOUT LIMITATION, IMPLIED WARRANTIES OF MERCHANTABILITY AND FITNESS FOR A PARTICULAR PURPOSE, DURABILITY OR DESCRIPTION OF THE PRODUCT, ITS NON-INFRINGEMENT OF ANY RELEVANT PATENTS OR TRADEMARKS, AND ITS COMPLIANCE WITH OR NON-VIOLATION OF ANY APPLICABLE ENVIRONMENTAL, HEALTH OR SAFETY LEGISLATION; THE TERM OF ANY OTHER WARRANTY NOT HEREBY CONTRACTUALLY EXCLUDED IS LIMITED SUCH THAT IT SHALL NOT EXTEND BEYOND TWENTY-FOUR (24) MONTHS FROM THE PRODUCTION DATE, TO THE EXTENT THAT SUCH LIMITATION IS ALLOWED BY THE GOVERNING LAW.

**Product Warranty Return Procedure** All Products that are believed to have defects in workmanship or materials must be returned, together with a written description of the defect, to the tekmar Representative assigned to the territory in which such Product is located. If tekmar receives an inquiry from someone other than a tekmar Representative, including an inquiry from Purchaser (if not a tekmar Representative) or Purchaser's customers, regarding a potential warranty claim, tekmar's sole obligation shall be to provide the address and other contact information regarding the appropriate Representative.

WARNING: This product contains chemicals known to the State of California to cause cancer and birth defects or other reproductive harm. For more information: [www.watts.com/prop65](http://www.watts.com/prop65)



Product design, software and literature are Copyright ©2014 by tekmar Control Systems Ltd., A Watts Water Technologies Company. Head Office: 5100 Silver Star Road, Vernon, B.C. Canada V1B 3K4, 250-545-7749, Fax: 250-545-0650 Web Site: [www.tekmarControls.com](http://www.tekmarControls.com)