

Multi-Staging

D 284

08/14

Replaces: 04/14

A Flexible Solution for Commercial & Multi-Residential Heating Plants

The Boiler Control 284 is designed to operate up to four boilers to accurately maintain a target water temperature. The 284 operates both condensing & non-condensing boilers that are either modulating, single stage or two stage to provide a flexible, cost effective mixed boiler plant solution with better system performance.

The target water temperature is based on outdoor temperature reset or a fixed setpoint for space or process heating applications. Additional loads supplied by the 284 include

domestic hot water & fixed setpoint heating. Boiler equal run-time rotation, stand-by primary pump operation & pump exercising all increase boiler plant reliability.

The 284 communicates with a Building Automation System (BAS) using BACnet® IP or Modbus® for remote monitoring & adjustment capability. tekmarNet® Thermostats or a tN4 Gateway 483 can be added to optimize system performance & provide remote monitoring capability.



Features

- Outdoor temperature reset
- Programmable schedules
- tekmarNet® compatible
- Control up to four boilers
- Condensing & non-condensing boiler groups
- Modulating, single stage or two stage
- Boiler isolation valves
- BACnet® IP or Modbus® communication
- Primary pump sequencing
- DHW priority
- Setpoint operation
- Combustion air damper control
- Energy, flow & pressure monitoring

Benefits

- Reduce energy costs
- Prolong equipment life
- Provide boiler redundancy
- Provide primary pump redundancy
- Remote monitoring & adjustment options
- Combine mid & high efficiency boilers to lower component cost



BACnet is a registered trademark of ASHRAE. ASHRAE does not endorse, approve or test products for compliance with ASHRAE standards. Compliance of listed products to the requirements of ASHRAE Standard 135 is the responsibility of BACnet International (BI). BTL is a registered trademark of BI.

Table of Contents

Sequence of Operation	2	Testing the Control Wiring	31
Boiler Setup	2	Control Settings.....	33
System Setup	5	Access Level	33
Boiler Plant Operation	7	DIP Switch Settings.....	33
Outdoor Temperature Reset Operation	10	User Interface.....	34
Setpoint Operation	12	Display & Symbols.....	34
Energy Management System (EMS) Operation.....	13	Navigating the Display.....	35
Indirect Domestic Hot Water (IDHW) Operation	14	View Menu	35
Dedicated Domestic Hot Water (DDHW) Operation	17	Setup Menu	37
Building Automation System (BAS) Operation.....	17	Source # Menu	43
Pump Operation	18	BAS Menu.....	45
C.A. Damper & DHW Recirculation.....	20	Monitor # Menu.....	47
Setting the Schedule	20	Monitor Menu	48
Time Clock.....	21	Time Menu	50
tekmarNet®4 Communication.....	21	Schedule Menu	51
Installation	22	Toolbox Menu	52
Installation Location.....	22	Manual Override	54
Control Wiring.....	23	Troubleshooting.....	56
Sensor Installation & Wiring.....	26	Error Messages	56
EMS, Modbus® & BACnet® Connections	29	Technical Data	60
Wiring the tekmarNet® Devices	30	Limited Warranty & Product Return Procedure.....	60
Testing the Sensor Wiring	30		

Sequence of Operation

Boiler (Source (#) Menu) Setup & Operation

The 284 is able to operate up to four boilers as a heat source. Each boiler is independently configured allowing for maximum plant flexibility.

Boiler Enable

This setting selects whether the boiler is operational or not.

OFF

The boiler is disabled & will not be included in the plant operation.

AUTO

The boiler is enabled & will be included in the plant operation.

Copy Boiler 1

Many boiler installations will have multiple identical boilers. To reduce the number of settings required, certain settings of boiler 1 are copied to boiler 2 by setting the Boiler 2 Copy setting to Boil1. Copy settings are also available for boiler 3 & boiler 4.

OFF

The settings from boiler 1 are not copied. This allows for individual boiler settings.

Boil 1

The settings from boiler 1 are copied.

Condensing

This setting selects whether the boiler is condensing or non-condensing & defines what boiler group it is part of.

NO

The boiler is non-condensing & is part of the non-condensing boiler group.

YES

The boiler is condensing & is part of the condensing boiler group.

Boiler Type

The 284 has four different boiler types to choose from. Use the Boil TYPE setting to select one of the following:

MOD

The modulating output operates a modulating boiler by controlling the burner firing rate. The Stage 1 relay is also used to give a boiler enable to allow the modulating boiler to go through ignition sequence. The Stage 1 relay may not be required on all modulating boilers.

1STG

The Stage 1 relay operates a single, stage boiler by cycling the burner stage on & off.

2STG

The Stage 1 & Stage 2 relays operate a single, two stage boiler by cycling the burner stages on & off.

EMS

The modulating output operates a boiler that interprets an analog input signal as a target temperature. The temperature rails (minimum and maximum) are adjustable between 50°F (10.0°C) & 210°F (99.0°C).

• VDC SIGN MIN

Sets the minimum analog Vdc signal which corresponds to the minimum temperature (EMS TEMP MIN).

• EMS TEMP MIN

Sets the temperature on the low end which corresponds to the minimum analog signal (Vdc Min / 4 mA).

• EMS TEMP MAX

Sets the temperature on the high end which corresponds to the maximum analog signal (10 Vdc / 20 mA).

Modulating Type

The MOD TYPE setting selects the analog output signal used for modulating (MOD) and EMS boiler types.

0-10

The modulating output is 0-10 V (dc).

4-20

The modulating output is 4-20 mA.

The 4-20 mA output can be converted to a 0 - 135 Ω output using a 0 - 135 Ω Converter 005. Refer to the Modulating Boiler Wiring section of the Control Wiring section.

Fire Delay

The Fire Delay sets the time it takes for the boiler to generate flame from the time the boiler turns on.

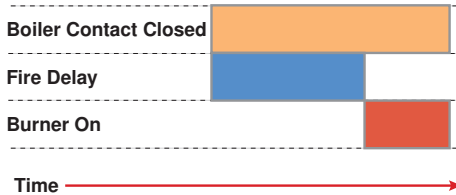

Modulation Delay

The MOD DELAY is the time that the boiler burner must hold the modulation of the boiler at a minimum before allowing it to modulate any further.

Boiler Mass

The Boil MASS setting selects the thermal mass characteristics of each boiler. Operation of the boiler can become unstable if the incorrect Boiler Mass setting is chosen. A key sign of unstable boiler operation is that the flame will continue to increase & then decrease in short periods of time. By choosing a lower boiler mass setting, the boiler response will become more stable.

LOW

The LO setting is selected if the boiler that is used has a low thermal mass. This means that the boiler has very small water content & has very little metal in the heat exchanger. A boiler that has a low thermal mass comes up to temperature quite rapidly when fired. This is typical of many copper fin-tube boilers.

The Low mass setting (LO) provides a fast response to the heating system.

MED

The MED setting is selected if the boiler that is used has a medium thermal mass. This means that the boiler either has a large water content & a low metal content or a low water content & a high metal content. This is typical of many modern residential cast iron boilers or steel tube boilers.

The Med mass setting provides a moderate response to the heating system.

HI

The HI setting is selected if the boiler that is used has a high thermal mass. This means that the boiler has both large water content & a large metal content. A boiler that has a high thermal mass is relatively slow in coming up to temperature. This is typical of many commercial cast iron & steel tube boilers.

The Hi mass setting provides a slow response to the heating system.

Low Fire & High Fire Boiler Output

In order to accommodate different boiler capacities in the same system, a low fire & high fire boiler output for each boiler

can be set. This allows the control to properly operate the boilers using either sequential or parallel modulation. Each boiler typically has a rating plate that specifies the minimum & maximum output. This information is also available in the boiler manual.

The minimum & maximum boiler output is expressed in MBtu/h. 1 MBtu/h = 1,000 Btu / hour. The range is from 10 MBtu/h to 9,990 MBtu/h.

For example, if a boiler has a maximum output of 100,000 Btu / hr & a minimum output of 20,000 Btu / hr (turn down ratio of 5):

$$\text{Maximum Boiler Output} = \frac{100,000}{1,000} = 100 \text{ MBtu/h}$$

$$\text{Minimum Boiler Output} = \frac{20,000}{1,000} = 20 \text{ MBtu/h}$$

Motor Speed

The MOTOR SPD is the amount of time the boiler requires to go from 0% modulation to 100% modulation.

Gas valve actuating motors have a design time from fully closed to fully opened which can be found in the manufacturer's manual. The Motor Speed should be set to this time.

The Motor Speed setting for a Variable Frequency Drive (VFD) is the amount of time required to go from a stopped position to 100% fan speed. Since a VFD has a very quick response rate, it may be necessary to increase the Motor Speed setting in order to increase the stability of the boiler modulation.



Start Modulation

The START MOD setting is the lowest modulation output required to obtain proper ignition. Whenever boiler operation is required, the control outputs an analog signal corresponding to the Start Modulation setting & closes the boiler contact to turn on the burner. After the Fire Delay has elapsed & the burner is ignited, the control modulates the firing rate between the Minimum Modulation setting & the Maximum Modulation setting.

Minimum Modulation

The MIN MOD is the lowest signal the control can send to modulate the boiler. This operates the boiler at low fire. Use the MIN MOD setting in the Adjust Menu to select an appropriate boiler minimum modulation.

- Refer to the boiler manufacturer's literature to determine the minimum output voltage V (dc) or current (mA) that the boiler will successfully operate at.

For 0 to 10 V (dc):

Minimum Modulation =

$$\frac{\text{Boiler's Minimum Input Signal}}{10 \text{ V (dc)}} \times 100\%$$

For 4 to 20 mA:

Minimum Modulation =

$$\frac{\text{Boiler's Minimum Input Signal} - 4\text{mA}}{16 \text{ mA}} \times 100\%$$

Example:

A boiler requires a 1.8 V (dc) signal to fire the boiler at low fire. The boiler can be modulated to 10 V (dc) where it reaches high fire.

$$\text{Minimum Modulation} = \frac{1.8 \text{ V}}{10 \text{ V}} \times 100\% = 18\%$$

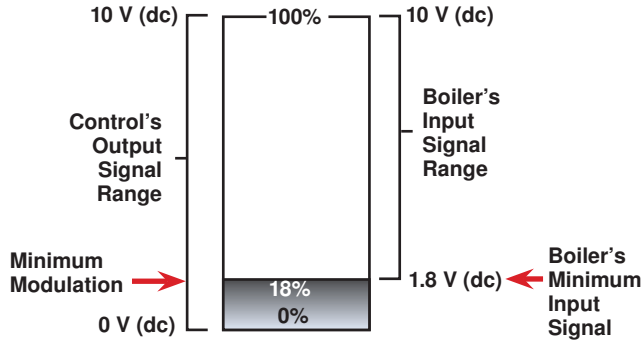

Maximum Modulation

The Maximum Modulation is the highest signal the control can send to modulate the boiler. For boilers with electronic operators, the boiler's input signal range may not match the output signal range of the 284. Use the MAX MOD setting in the Source (#) Menu to select an appropriate boiler maximum modulation.

For 0 to 10 V (dc):

Maximum Modulation =

$$\frac{\text{Boiler's Maximum Input Signal}}{10 \text{ V (dc)}} \times 100\%$$

For 4 to 20 mA:

Maximum Modulation =

$$\frac{\text{Boiler's Maximum Input Signal} - 4\text{mA}}{16 \text{ mA}} \times 100\%$$

Example:

A boiler's input signal range is 0 to 9 V (dc). The 284 control has an output signal range of 0 to 10 V (dc).

$$\text{Maximum Modulation} = \frac{9 \text{ V}}{10 \text{ V}} \times 100\% = 90\%$$

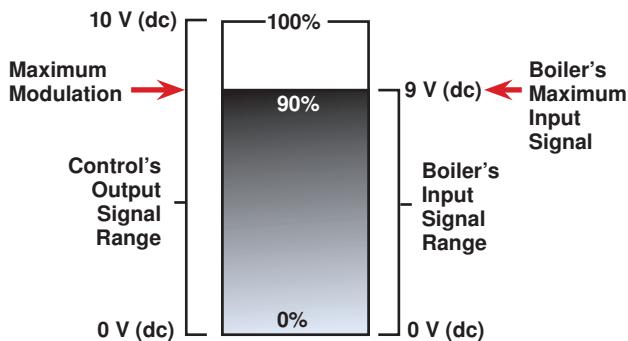

Maximum Boiler Outlet

The control has the capability for each boiler outlet temperature to be monitored & limited. The MAX OUT setting sets the maximum boiler outlet temperature. For modulating boilers, as the boiler outlet temperature approaches the boiler outlet maximum temperature, the control will reduce the firing rate. Once the boiler outlet temperature reaches the boiler outlet maximum temperature less 15°F (8.0°C), firing rate reduction will begin. Once the boiler outlet temperature reaches the boiler outlet maximum temperature less 5°F (2.5°C), the firing rate will be reduced to minimum modulation. If the boiler outlet temperature reaches the boiler outlet maximum, the boiler is turned off. In order for the boiler to be able to be turned back on again, the boiler outlet temperature must drop 5°F (2.5°C) below the boiler outlet maximum.

If MAX OUT is set to OFF, the control only monitors the boiler outlet temperature.

Boiler Pump / Valve Post Purge

This setting sets the amount of time the control operates the boiler pump / valve after the boiler is turned off. This will purge heat out of the boiler, reducing stand-by losses, & also aid in reducing "kettling". The amount of time for the boiler pump post purge is adjustable between 10 seconds & 20:00 minutes. Auto is also available in which the control automatically determines the amount of time based on the boiler mass.

System Setup & Operation

Application Mode

There are five possible application modes that the 284 can be configured for including:

- Outdoor Temperature Reset (RSET)
- Fixed Setpoint (SETP)
- Dedicated Domestic Hot Water (DDHW)
- Energy Management System (EMS)
- Building Automation System (BAS)

Refer to the appropriate section of this brochure for a description of the each of the application modes.

Boiler Minimum

The Boil MIN is the lowest temperature that the control is allowed to use as a boiler target temperature. During mild conditions, if the control calculates a boiler target temperature that is below the boiler minimum setting, the boiler target temperature is adjusted to at least the boiler minimum setting. MIN is displayed in the status field while viewing the boiler supply or target & when the boiler target is boiler minimum & the boiler supply is less than boiler minimum plus 5°F (2.5°C). Set the Boiler Minimum setting to the boiler manufacturer's recommended temperature.

The Boil MIN is only applicable when at least one of the boilers is configured for non-condensing.

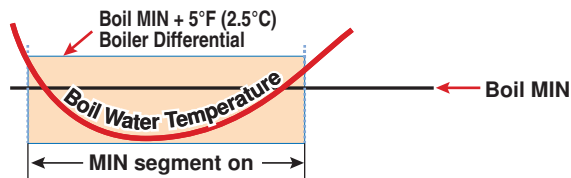

Boiler Maximum

The Boil MAX is the highest temperature that the control is allowed to use as a boiler target temperature. MAX is displayed in the status field viewing the boiler supply or target & when the boiler target is boiler maximum & the boiler supply is greater than boiler maximum minus 5°F (2.5°C). Set the boiler maximum setting below the boiler operator or aquastat temperature.

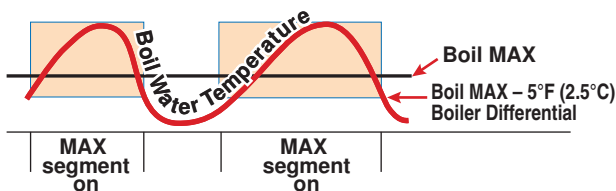

Boiler Differential

Both on/off (single stage & two stage) & modulating boilers are operated with a differential. In some cases, a modulating boiler must be operated with a differential at low fire. This indicates the load is smaller than the minimum modulation of the boiler. For modulating boilers, the differential no longer applies once operating the boiler above low fire.

The differential operates by turning on the boiler when the boiler supply water temperature is 1/2 of the differential below the boiler target temperature. As the boiler supply water temperature reaches 1/2 of the differential above the boiler target temperature, the boiler is shut off.

Manual Differential

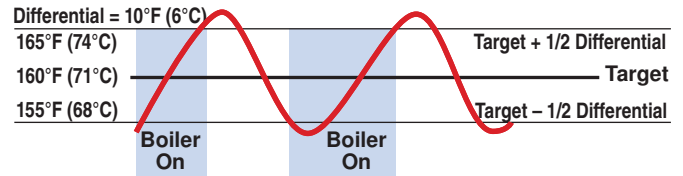

Automatic Differential

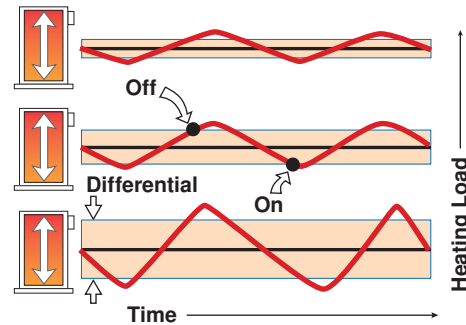

Exercising

The control will exercise all pumps, & tN4 zones (zone valves & zone pumps) for 10 seconds every three days of inactivity to prevent seizure. To enable exercising, switch the Exercise / Off DIP to the Exercise position.

Boost

When the control changes from the UnOccupied mode to the Occupied mode, it enters into a boosting mode. In this mode, the supply water temperature to the system is raised above its normal values for a period of time to provide a faster recovery from the setback temperature of the building. The maximum length of the boost is selected using the BOOST setting in the Setup menu.

Typical settings for the boost function vary between 30 minutes & two hours for buildings that have a fast responding heating system. For buildings that have a slow responding heating system, a setting between four hours & eight hours is typical. After a boost time is selected, the setback timer must be adjusted to come out of setback some time in advance of the desired occupied time. This time in advance is normally the same as the BOOST setting.

If the building is not up to temperature at the correct time, the BOOST setting should be lengthened & the setback timer should be adjusted accordingly. If the building is up to temperature before the required time, the BOOST setting should be shortened & the setback timer should be adjusted accordingly. If the system is operating near its design conditions or if the supply water temperature is being limited by settings made in the control, the time required to bring the building up to temperature may be longer than expected.

Flow Monitoring

The control has the capability to monitor flow rate through the connection of a 4-20 mA style flow sensor. Flow is measured in either gallons per minute (gpm) or meters cubed per hour (m³/h). The units are adjustable through the FLOW UNIT setting in the Toolbox menu.

Varying flow rates are accommodated & the flow range of the flow sensor being used is configured using the following items in the Setup menu:

- FLOW RATE 4 mA

Sets the flow rate on the low end which corresponds to 4 mA.

- FLOW RATE 20 mA

Sets the flow rate on the high end which corresponds to 20mA.

Examples of compatible aftermarket flow sensors include the Kele SDI series, 2200 & 3100 series and 200 series (requires 310 transmitter).

In addition to flow monitoring, the flow sensor can also be used to prove primary pump flow. Refer to the Pump Operation section of this brochure for additional details.

Energy Monitoring

The control has the capability to monitor Energy. The control requires the boiler supply, boiler return sensor & the flow sensor in order to calculate & display energy in either Therms (THRM) or Gigajoules (GJ). The units are adjustable through the ENERGY UNIT setting in the Toolbox menu. Select MBtu for display in THRM and kWh for display in GJ.

Pressure Monitoring

The control has the capability to monitor system pressure through the connection of a V(dc) style pressure sensor with a signal range of 0.5 to 4.5 V (dc). Pressure is measured in either psi or kPa. The units are adjustable through the PRESSURE UNIT setting in the Toolbox menu.

The Pressure Sensor Range item in the Setup menu selects from the available pressure ranges for the pressure sensor to be used.

Examples of compatible aftermarket pressure sensors include the Honeywell PX2 (AA) series and the Measurement Specialties 7100 series.

Vent Temperature Monitoring & Limiting

The control has the capability to measure & limit the vent temperature. The VENT MAX setting defines the operation of the vent sensor. If the vent temperature exceeds the VENT MAX, the boiler plant is shut down. The boiler plant will not be allowed to operate until the vent temperature drops 10°F (6°C) below the VENT MAX. If OFF is selected, the vent temperature is only monitored.

Alert Relay

The control has an Alert relay that closes whenever a control or sensor error is detected, or when a warning or limiting condition is detected. When the alert contact closes, refer to the Error Messages section of this brochure to determine the cause of the alert & how to clear the error.

Boiler Alert

If no temperature increase is detected at the boiler supply sensor within this delay period, the Alert relay will close & the control will display the NO HEAT error message. To clear the error, press the CLEAR button while viewing the error message.

Boiler Plant Operation

The 284 is able to operate up to four boilers to maintain a boiler target temperature. Proportional, Integral & Derivative (PID) logic is used in order to satisfy the boiler target temperature for all plant configurations with the exception of Dedicated Domestic Hot Water (DDHW). Proportional (P) logic is used for DDHW. For proper operation of the boilers, the 284 must be the only control that determines when a boiler is to fire.

***Important:** The boiler operator, or aquastat, remains in the burner circuit & acts as a secondary upper limit on the boiler temperature. The boiler aquastat temperature setting must be adjusted above the 284's boiler maximum setting in order to prevent short cycling of the burner.

Boiler Operation

Single Stage On/Off Boiler

Once a boiler is required to operate, the control turns on the Stage 1 relay. Once the control turns on the Stage 1 relay, it will display the "Boiler" icon & "100%" under the respective boiler output status in the display.

Two Stage On/Off Boiler

Once a boiler is required to operate, the control turns on the Stage 1 relay. Once the Fire Delay time plus the Stage Delay time has expired, the control can turn on the Stage 2 relay if it is required. Once the control turns on the Stage 1 relay, it will display the "Boiler" icon & "50%" under the respective boiler output status in the display. Once the control turns on the Stage 2 relay, it will display "100%".

Modulating Boiler

Once a boiler is required to operate, the control outputs an analog signal corresponding to the Start Modulation setting & then turns on the Stage 1 relay. Once the Fire Delay time has expired, the modulating output is adjusted to the Minimum Modulation setting. The control then holds the modulating output at the Minimum Modulation until the Minimum Modulation Delay time has elapsed. The control can then adjust the modulating output from the Minimum Modulation as required. Once the control turns on the Stage 1 relay, it will display the "Boiler" under the respective boiler output status in the display. The current firing rate is also displayed in the boiler output field.

EMS Boiler

Once a boiler is required to operate, the control outputs an appropriate analog signal corresponding to the boiler target temperature & then turns on the Stage 1 relay. Once the control turns on the Stage 1 relay, it will display the "Boiler" under the respective boiler output status in the display. The target water temperature is also displayed in the boiler output field.

Boiler Target Temperature

The Boil TARG temperature is determined by the application mode & the type of call received. The control displays the temperature that it is currently trying to maintain at the boiler supply sensor in the View menu. If the control does not presently have a requirement for heat, it does not show a boiler target temperature. Instead, "---" is displayed in the LCD.

Stage Delay

The STG DELAY is the minimum time delay between the firing of each boiler or boiler stage. After this delay has expired the control can fire the next boiler or boiler stage if it is required. This

setting can be adjusted manually or set to an automatic setting. When the automatic setting is used, the control determines the best stage delay based on the operation of the system.

Modulation Mode

When using multiple modulating boilers, a selection must be made regarding the sequencing of the boilers. Two modulation mode settings are provided considering condensing & non-condensing boiler groups.

Modulation Mode is not available when the Application Mode is configured for Dedicated Domestic Hot Water (DDHW).

- MOD COND (Modulation Mode - Modulating, Condensing Boiler Group)

This setting is applicable for a group at least two modulating, condensing boilers.

- MOD NC (Modulation Mode - Modulating, Non-Condensing Boiler Group)

This setting is applicable for a group of at least two modulating, non-condensing boilers.

Sequential Modulation (SEQ)

With Sequential Modulation, the control will turn on the fewest boilers possible to meet the load. The control will bring a boiler from its Minimum Modulation setting up to its Maximum Modulation setting before bringing on another boiler. When another boiler is turned on, the previous boiler will keep its output at full fire.

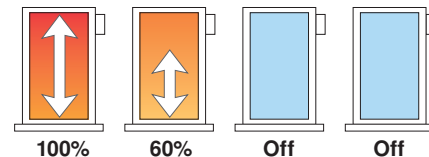

Parallel Modulation (PAR)

With Parallel Modulation, the control will turn on the most boilers possible to meet the load. The control will bring on the first boiler at Minimum Modulation & does not increase its modulation. If more boiler output is required, the second boiler will turn on at Minimum Modulation & does not increase its modulation. Additional boilers are turned on at their Minimum Modulation setting until all boilers are on. If still more boiler output is required, all boilers are modulated up in parallel until they reach their Maximum Modulation settings.

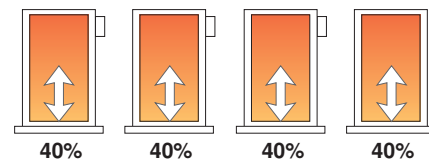

Staging Mode Setup

When using multiple two-stage boilers, a selection must be made regarding the staging order of the boilers. Two staging modes are provided considering condensing & non-condensing boiler groups.

- STG COND (Staging Mode - Two-Stage, Condensing Boiler Group)

This setting is applicable for a group of at least two, two-stage condensing boilers.

- STG NC (Staging Mode - Two-Stage Non-Condensing Boiler Group)

This setting is applicable for a group of at least two, two-stage non-condensing boilers.

Lo/Hi

If the Lo/Hi staging option is selected the control stages in sequence all of the stages in a single boiler. Once all of the stages are turned on, the control then stages in sequence all of the stages of the next boiler in the rotation sequence.

Lo/Lo

If the Lo/Lo staging option is selected, the control stages all of the Lo stage outputs in all of the boilers first. Once all of the boilers are operating on their Lo stages, the control then operates the second stage in each boiler in the same order.

Boiler Group Rotation

The control has two rotation settings including one for the condensing boiler group & another for the non-condensing boiler group.

- ROT COND (Rotation - Condensing Boiler Group)

This setting is applicable for a group of at least two, two-stage condensing boilers.

- ROT NC (Rotation - Non-Condensing Boiler Group)

This setting is applicable for a group of at least two, two-stage non-condensing boilers.

The Rotate feature changes the firing order of the boilers whenever one boiler accumulates 48 hours more run time than any other boiler. Rotation will be forced if any boiler accumulates 60 hours more run time. After each rotation, the boiler with the least running hours is the first to fire & the boiler with the most running hours is the last to fire. This function ensures that all of the boilers receive equal amounts of use. When the Rotation setting is set to Off, the firing sequence always begins with lowest boiler to the highest boiler.

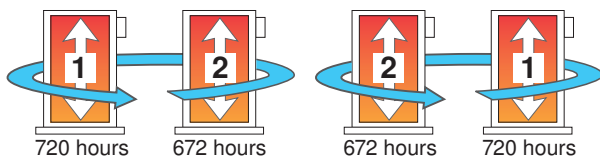

To reset the rotation sequence, clear the Burner Run Time in the Monitor (#) Menu.

Boiler Run Time Monitoring

The running time of each boiler is logged in its respective Monitor (#) menu. To reset the running time, select the appropriate BURNER item in the Monitor (#) menu & select CLEAR until "0" is displayed.

Fixed Lead

When the boiler plant includes only one boiler group, either a condensing or a non-condensing group, a selection must be made regarding operation of the lead boiler.

ON

In some applications, it may be desirable to have the first boiler fire first at all times while the firing sequence of the remaining boilers is changed using Equal Run Time Rotation. This configuration is typical of installations where the boiler plant includes similar boilers but the first boiler is required to be the first to fire in order to establish sufficient draft for venting. With a fixed lead rotation, the lead boiler is always turned on first & turned off first. The Fixed Lead is always applied to the boiler 1 output.

OFF

The lead boiler is not fixed to operate first in the firing sequence. It is included in the rotation sequence with the other boilers.

Fixed Last

When the boiler plant includes only one boiler group, either a condensing or a non-condensing group, a selection must be made regarding operation of the last boiler.

ON

In some applications, it may be desirable to have the last boiler fire last at all times while the firing sequence of the remaining boilers is changed using Equal Run Time Rotation. This configuration is typical of installations where the boiler plant includes higher efficient boilers & a single lesser efficient boiler. The lesser efficient boiler is only desired to be operated when all other boilers in the plant are on & the load cannot be satisfied. With a fixed last rotation, the last boiler is the last to turn on & the first to turn off. The Fixed Last is always applied to the boiler 4 output.

OFF

The last boiler is not fixed to operate last in the firing sequence. It is included in the rotation sequence with the other boilers.

Condensing & Non-Condensing Boiler Groups

Operating a boiler plant that contains both condensing (high initial cost) & non-condensing (lower initial cost) boilers allows the boiler plant to achieve nearly the same operating efficiencies as operating all condensing boilers but at a much lower installed cost to the building owner. High system efficiency can be achieved as long as the condensing boilers are the first to operate in the firing sequence. During mild weather, the lead condensing boilers operate at lower boiler temperatures & achieve their peak boiler efficiencies while the non-condensing boilers are rarely operated. During very cold weather, the boiler target temperature is often above the boiler's condensation point & the condensing & non-condensing boilers operate together at roughly the same efficiency level.

When a condensing boiler is operating, it is desirable to operate the boilers without a boiler minimum temperature being applied to the boiler target. This allows the condensing boiler to operate at its maximum efficiency. When a non-condensing boiler is operating, a boiler minimum temperature should be applied to the boiler target to prevent damage to the non-condensing boiler's heat exchanger from sustained flue gas condensation.

The 284 supports operation of a condensing & a non-condensing boiler group. A condensing boiler group is created when at least one boiler is selected to be condensing & a non-condensing boiler group is created when at least one boiler is selected to be non-condensing. The condensing boiler group is always sequenced on first, followed by the non-condensing boiler group.

Boiler Plant Flow (PLANT FLW)

The control supports the option of having all boilers in the plant to use either a pump or an isolation valve.

Boiler Pump (PUMP)

PUMP is to be selected when each boiler in the plant includes its own circulator. This is typical of a conventional boiler plant configuration that includes boilers that are flow sensitive.

PUMP is also to be selected when each boiler in the plant neither includes a pump nor an isolation valve. This boiler plant configuration could be used with boilers that are not flow sensitive. It is expected that the primary pump provides flow through all boilers, regardless of whether they are on or off.

Boiler Isolation Valve (VALV)

VALVE is to be selected when each boiler in the plant includes an isolation valve. This boiler plant configuration could be used with boilers that are not flow sensitive & is typical of systems that incorporate a variable frequency drive (VFD) with the primary pump. Systems incorporating variable speed primary pumping (via a VFD) allow for increased pump electrical energy savings during milder heating loads.

The purpose of the isolation valve is to isolate the boiler from plant operation when the boiler is turned off. As a boiler is isolated, the VFD will adjust the flow rate accordingly. The isolation valve must include a spring return motor that is of the normally open / fail open type. As the control does not include a proof input for proving that the isolation valve is fully open prior to burner ignition, the motor end switch, if available, should be wired into the burner's safety circuit.

Boiler isolation valve operation is dependent on whether the Heat Call is permanent or intermittent.

- Permanent Heat Call (e.g. external Heat Call shorted)

As the heating load becomes satisfied & a boiler is required to be turned off, the boiler will turn off while its isolation valve remains open for the boiler purge period time. After the boiler purge time expires, the isolation valve will close. When the last boiler in the plant turns off, its isolation valve will remain open, allowing for a flow path of the primary pump.

When there is a subsequent requirement for plant operation and a boiler is required to be turned on, its isolation valve will be opened (if not already open) prior to burner ignition. Also, if applicable, the isolation valve of the last boiler turned off in the previous cycle will be turned off.

- Intermittent Heat Call (e.g. external Heat Call interlocked with space heating thermostat)

When the Heat Call is present, operation is consistent with the operation defined for a Permanent Heat Call.

When the external Heat Call is removed, the isolation valve of every boiler will be opened. When the external Heat Call is re-applied, the control will keep open the valve of the boiler that is due to be turned on first. The isolation valves of all other boilers will be closed.

Outdoor Temperature Reset Operation

Outdoor Temperature Reset is available by setting the Application Mode in the Setup Menu to RSET.

In a heating system, the rate of heat supplied to the building must equal the rate at which heat is lost. If the two rates are not equal, the building will either cool off or over heat.

The rate of building heat loss depends mostly on the outdoor temperature. Outdoor Reset allows a hot water heating system to increase the water temperature, adding heat to the building, as the outdoor temperature drops. The rate at which the water temperature is changed as a function of outdoor temperature is defined by the characterized heating curve.

Indirect Domestic Hot Water (IDHW) & setpoint operation are both available during outdoor temperature reset operation.

Heat Call

A Heat Call is required in order for the control to provide target water temperature for the space heating system. Once the control registers a Heat Call, it will display the "Heat" icon under the Calls in the display. A heat call can be provided in two ways:

Contact Closure

A dry contact or 24 V (ac) signal is applied across the Heat Call terminals 5 & 6.

tekmarNet® Device

A tN4 thermostat wired to one of the tN4 Bus terminals.

Characterized Heating Curve

A characterized heating curve determines the amount the target water temperature is raised for every 1° drop in outdoor air temperature.

The characterized heating curve takes into account the type of terminal unit that the system is using. Since different types of heating terminal units transfer heat to a space using different proportions of radiation, convection & conduction, the supply water temperature must be controlled differently. The control uses the terminal unit setting to vary the supply water temperature to suit the terminal unit being used. This improves the control of the air temperature in the building.

Boiler Characterized Heating Curve

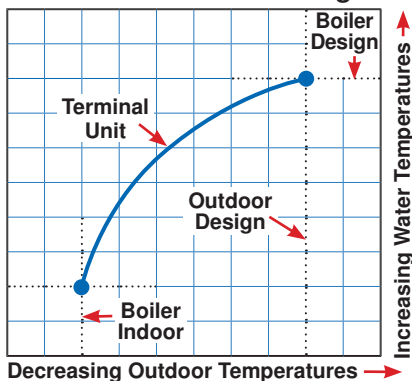

Terminal Unit

Select the appropriate terminal unit in the Setup Menu. This will change the shape of the characterized heating curve to better match the heat transfer properties of that specific terminal unit.

Hydronic Radiant Floor (HRF1)

A heavy or high mass, hydronic radiant floor system. This type of a hydronic radiant floor is embedded in either a thick concrete or gypsum pour. This heating system has a large thermal mass & is slow acting.

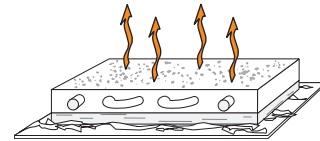

Hydronic Radiant Floor (HRF2)

A light or low mass, hydronic radiant floor system. Most commonly, this type of radiant heating system is attached to the bottom of a wood sub floor, suspended in the joist space, or sandwiched between the subfloor & the surface. This type of radiant system has a relatively low thermal mass & responds faster than a high mass system.

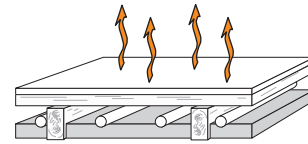

Fancoil (COIL)

A fancoil terminal unit or air handling unit (AHU) consisting of a hydronic heating coil & either a fan or blower. Air is forced across the coil at a constant velocity by the fan or blower & is then delivered into the building space.

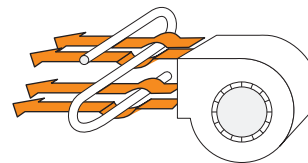

Fin-tube Convactor (CONV)

A convactor terminal unit is made up of a heating element with fins on it. This type of terminal unit relies on the natural convection of air across the heating element to deliver heated air into the space. The amount of natural convection is dependant on the supply water temperature to the heating element & the room air temperature.

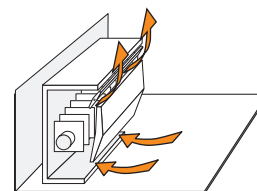

Radiator (RAD)

A radiator terminal unit has a large heated surface that is exposed to the room. A radiator provides heat to the room through radiant heat transfer & natural convection.

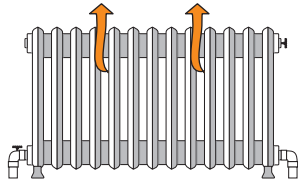

Baseboard (BASE)

A baseboard terminal unit is similar to a radiator, but has a low profile & is installed at the base of the wall. The proportion of heat transferred by radiation from a baseboard is greater than that from a fin-tube convector.

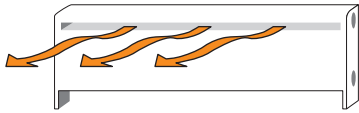

Boiler Terminal Unit Defaults

When a terminal unit is selected for boiler zones, the control loads default values for the boiler design, boiler maximum supply, & boiler minimum supply temperatures. The factory defaults can be changed to better match the installed system. Locate the Terminal Unit setting in the Setup menu.

Terminal Unit	Boil DSGN	Boil MAX	*Boil MIN
High Mass Radiant	120°F (49.0°C)	140°F (60.0°C)	140°F (60.0°C)
Low Mass Radiant	140°F (60.0°C)	160°F (71°C)	140°F (60.0°C)
Fancoil	190°F (88.0°C)	210°F (99.0°C)	140°F (60.0°C)
Fin-Tube Convactor	180°F (82.0°C)	200°F (93.5°C)	140°F (60.0°C)
Radiator	160°F (71.0°C)	180°F (82.0°C)	140°F (60.0°C)
Baseboard	150°F (65.5°C)	170°F (76.5°C)	140°F (60.0°C)

Boil MIN is only available if at least one boiler is set to non-condensing. If all available boilers are set to condensing, Boil MIN is not available & is hard-coded to OFF.

Room

The Room setting is the desired room air temperature, according to the outdoor reset heating curve. The Room setting parallel shifts the heating curve up or down to change the target water temperature. Adjust the Room setting to increase or decrease the amount of heat available to the building. Once the heating curve has been set up properly, the Room setting is the only setting that needs to be adjusted. The default Room setting is 70°F (21.0°C), & it can be adjusted for both the occupied & unoccupied periods.

Outdoor Design

The outdoor design temperature is typically the coldest outdoor air temperature of the year. This temperature is used when doing the heat loss calculations for the building & is used to size the heating system equipment. If a cold outdoor design temperature is selected, the supply water temperature rises gradually as the outdoor temperature drops. If a warm outdoor design temperature is selected, the supply water temperature rises rapidly as the outdoor temperature drops.

Boiler Indoor

The boiler indoor design temperature is the indoor temperature the heating designer chose while calculating the heat loss for the boiler water heated zones. This temperature is typically 70°F (21.0°C). This setting establishes the beginning of the boiler characterized heating curve.

Boiler Design

The boiler design supply temperature is the boiler water temperature required to heat the zones at the outdoor design temperature, or on the typical coldest day of the year.

(Default automatically changes based on terminal unit setting)

Warm Weather Shut Down (WWSD)

Warm Weather Shut Down disables the heating system when the outdoor air temperature rises above this programmable setting. When the control enters into WWSD, WWSD is indicated in the status field. WWSD is only available when the Application Mode is set to RSET.

While in WWSD, the control will still operate to provide Indirect Domestic Hot Water or Setpoint operation.

Setpoint Operation

Setpoint operation is dependant on the application mode setting.

- If the Application Mode is configured for Outdoor Temperature Reset (RSET) or Energy Management System (EMS), the control provides heat for an additional setpoint load. The control does respond to a Heat Call from a space heating system.
- If the Application Mode is configured for Setpoint (SETP), the control provides heat only for the setpoint load. The control does not respond to a Heat Call for space heating.

Indirect Domestic Hot Water (IDHW) operation is available during setpoint operation.

Setpoint Call

A Setpoint Call is required in order for the control to provide heat to a setpoint load, such as a spa, pool or snowmelt load. Once the control registers a Setpoint Call, it will display the "Setpoint" icon under the Calls in the display. A setpoint call can be provided in two ways:

Contact Closure

A dry contact or 24 V (ac) signal is applied across the Setpoint Call terminals 9 & 10.

tekmarNet® Setpoint Control with Sensor

A Setpoint Call is provided through the tekmarNet® system. This can be done through the tN4 Boiler Bus terminals with a tekmarNet® setpoint device such as a Setpoint Control 161.

Boiler Target Temperature During a Setpoint Call

When a Setpoint Call is present, a boiler target is determined.

- When using a Contact Closure, the boiler target is set to the SETP Setpoint setting.
- When using a tekmarNet® Setpoint Control, the boiler target is set to the devices Exchange Supply setting.

If there are multiple devices calling for heat, the boiler target is set to the highest temperature requirement.

Setpoint During UnOccupied

When using a Contact Closure, a second SETP Setpoint setting is available for the Unoccupied periods.

DIP Switch must be set to Setback to view UnOccupied items.

During the Away Scene, Setpoint Calls are ignored.

Setpoint Mode

The control has a Setpoint Mode setting that selects whether or not setpoint heating is operational.

OFF

Setpoint operation is not provided. All Setpoint Calls are ignored. If this mode is selected while setpoint operation is underway, all setpoint operation ceases.

ON

Setpoint heating is provided. All Setpoint Calls are responded to. Operation is dependant on the Primary Pump During Setpoint operation setting.

Primary Pump During Setpoint

This setting selects whether or not primary pump operation is required during setpoint heating.

OFF

The primary pump does not turn on during setpoint heating. It is assumed that the setpoint load pump will provide adequate flow through the setpoint load & the boiler system loop.

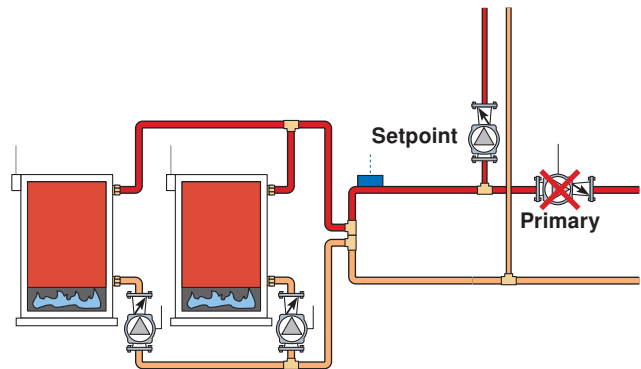

ON

The primary pump turns on during setpoint heating.

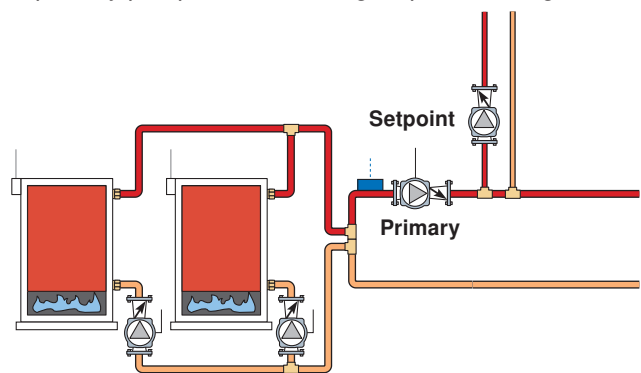

Setpoint Priority

This setting selects whether or not priority of setpoint over space heating is required. Setpoint priority stops or limits the delivery of heat to the space heating system while the setpoint load calls for heat. This allows for quick recovery of the load.

OFF

Setpoint priority is not provided. The primary pump can operate when a Heat Call is present. Heating zones are unaffected by setpoint heating.

ON

Setpoint priority is provided & is dependant on the type of space heating zones & whether or not the primary pump is required to operate during setpoint heating.

For non-tN4 space heating, the primary pump shuts off to provide priority. If the primary pump is required to operate for setpoint heating, priority requires the use of an external relay to force the heating zones off.

For tN4 space heating, the primary pump can operate when a Heat Call is present. If the boilers are unable to maintain the boiler target temperature, the tN4 zones are sequentially shut off using tN4 communication to provide priority.

Priority Override

Priority Override applies when Setpoint Priority is set to ON. It prevents the building from cooling off too much or the possibility of a potential freeze up during setpoint priority.

When set to auto, the priority time is calculated based on outdoor temperature. At or below the design outdoor temperature, 15 minutes are allowed for setpoint priority. At or above the Indoor Design temperature, 2 hours are allowed for setpoint priority. The time allowed for setpoint priority varies linearly between the above two points. There is a manual setting also available in the Setup menu.

The priority timer does not start timing until priority is selected & both a Setpoint Call & a Heat Call exist together. Once the allowed time for priority has elapsed, the control overrides the setpoint priority & resumes space heating.

Conditional Setpoint Priority

If the boiler supply temperature is maintained at or above the required temperature during setpoint heating, this indicates that the boilers have enough capacity for setpoint & possibly space heating as well. As long as the boiler supply temperature is maintained near the target, setpoint & heating occurs simultaneously.

Setpoint Post Purge

After a Setpoint Call from a tN4 device is removed, the control can perform a post purge. The control shuts off the boilers & continues to operate, if applicable, the primary pump. This purges the residual heat from the boilers into the setpoint load. The control continues this purge until one of the following occurs:

1. A Heat Call is detected.
2. The boiler supply drops 20°F (11.0°C) below the setpoint target temperature.
3. Two minutes elapse.

Energy Management System (EMS) Operation

The control can accept an external DC signal from an Energy Management System (EMS). The control converts the DC signal into the appropriate boiler target temperature for the space heating system.

EMS is available by setting the APP MODE in the Setup Menu to EMS.

Indirect Domestic Hot Water (IDHW) & setpoint are both available during EMS operation.

Heat Call

A Heat Call is required in order for the control to provide a target water temperature for the space heating system. Once the control registers a Heat Call, it will display the "Heat" icon under the Calls in the display.

A Heat Call is provided by:

Input Signal

An external signal is generated by applying a voltage between 0 V (dc) & 10 V (dc) across the EMS (+) In & Com (-) terminals (16 & 19). Voltages that exceed 10 V (dc) will still be considered a 10 V (dc) signal.

If the EMS signal goes below the minimum voltage, the "Heat" icon under the Calls in the display is turned off. The boiler target temperature is displayed as "---" to indicate that there is no longer a call for heating.

External Heat Call terminals are not operational.

EMS Signal

The control can accept either a 0-10 V (dc) signal or a 2-10 V (dc) signal. The EMS SGNL setting must be set to the proper setting based on the signal that is being sent to the control.

0 - 10 V (dc) or 0 - 20 mA

When the 0-10 V (dc) signal is selected, an input voltage of 1 V (dc) corresponds to a boiler target temperature of 50°F (10.0°C). An input voltage of 10 V (dc) corresponds to a boiler target temperature of 210°F (99.0°C). As the voltage varies linearly between 1 V (dc) & 10 V (dc) the boiler target temperature varies linearly between 50°F (10.0°C) & 210°F (99.0°C). If a voltage below 0.5 V (dc) is received the boiler target temperature is

displayed as "---" indicating that there is no longer a call for heating.

A 0 - 20 mA signal can be converted to a 0 - 10 V (dc) signal by installing a 500 Ω resistor between the EMS (+) In & Com (-) terminals (16 & 19).

2 - 10 V (dc) or 4 - 20 mA

When the 2 - 10 V (dc) signal is selected, an input voltage of 2 V (dc) corresponds to a boiler target temperature of 50°F (10.0°C). An input voltage of 10 V (dc) corresponds to a boiler target temperature of 210°F (99.0°C). As the voltage varies linearly between 2 V (dc) & 10 V (dc) the boiler target temperature varies linearly between 50°F (10.0°C) & 210°F (99.0°C). If a voltage below 1.5 V (dc) is received the boiler target temperature is displayed as "---" indicating that there is no longer a call for heating.

A 4 - 20 mA signal can be converted to a 2 - 10 V (dc) signal by installing a 500 Ω resistor between the EMS (+) In & Com (-) terminals (16 & 19).

CONVERSION TABLE 0 - 10		
0 - 20 mA*	0 - 10 V (dc)	Boiler Target
0	0	--- (OFF)
2	1	50°F (10.0°C)
4	2	68°F (20.0°C)
6	3	86°F (30.0°C)
8	4	103°F (39.5°C)
10	5	121°F (49.5°C)
12	6	139°F (59.5°C)
14	7	157°F (69.5°C)
16	8	174°F (79.0°C)
18	9	192°F (89.0°C)
20	10	210°F (99.0°C)

*Requires 500 Ω Resistor in Parallel

CONVERSION TABLE 2 - 10		
4 - 20 mA*	2 - 10 V (dc)	Boiler Target
0	0	--- (OFF)
4	2	50°F (10.0°C)
6	3	70°F (21.0°C)
8	4	90°F (32.0°C)
10	5	110°F (43.5°C)
12	6	130°F (54.5°C)
14	7	150°F (65.5°C)
16	8	170°F (76.5°C)
18	9	190°F (88.0°C)
20	10	210°F (99.0°C)

*Requires 500 Ω Resistor in Parallel

Example

Range	= 0 - 10 V (dc)	
Input	= 7 V (dc)	
Offset	= +5°F (3°C)	→ +5°F (3°C)
Boiler Target	=	162°F (72°C)

The minimum & maximum settings also apply for external input operation. For example, if a boiler minimum of 140°F (60.0°C) is set & the external signal received represents 80°F (27.0°C), the boiler target will be 140°F (60.0°C), MIN will also be displayed in the status field to indicate that a limiting condition is in effect. This also applies for the MAX limit.

EMS Offset

For external input operation, the boiler target (determined from the external input signal) may be fine tuned. The EMS OFFST setting is used to provide the fine tuning. The setting may be adjusted ±10°F (±5.5°C). When set to 0°F (0.0°C), if the temperature determined from the external signal is 140°F (60.0°C), the boiler target will be 140°F (60.0°C). When set to +5°F (+3.0°C) & with the same external signal represents 140°F (60.0°C), the boiler target will be 145°F (63.0°C).

Indirect Domestic Hot Water (IDHW) Operation

IDHW operation is applicable during the following application modes: outdoor temperature reset, fixed setpoint & EMS.

DHW Call

A DHW Call is required in order for the control to provide heat to an indirect DHW tank. Once the control registers a DHW Call, it will display the “DHW” icon under Calls in the display. A DHW Call can be provided in three ways:

DHW Tank Aquastat

If a DHW Tank Aquastat (mechanical switch) is used to apply a DHW Call, the tank is heated to the aquastat temperature setting. A dry contact or 24 V (ac) signal is applied across the IDHW Call terminals 7 & 8.

IDHW Sensor must be set to Off.

DHW Sensor

A DHW Tank Sensor provides superior temperature control of the tank compared to an aquastat. The control can register a DHW Call when a DHW Sensor is wired to terminals 21 & 22. Once the DHW Sensor temperature drops 1/2 of the IDHW Differential setting below the IDHW Setpoint, the control registers a DHW Call.

The IDHW Sensor must be set to On. There cannot be an external IDHW Call when using a DHW sensor.

tekmarNet® Setpoint Control with Sensor

A DHW Call is provided through the tekmarNet® system. This can be done through the tN4 Boiler Bus terminals with a tekmarNet® setpoint device such as a Setpoint Control 161.

DHW Differential

Due to large differences between the heating load & the DHW load, a separate DHW differential should be used whenever a DHW Call is present. This will improve staging & boiler cycling.

When using a DHW Sensor, a DHW Call is registered when the temperature at the DHW sensor drops the IDHW DIFF setting below the IDHW Setpoint setting. The DHW Call is satisfied once the temperature at the DHW Sensor rises to the IDHW Setpoint setting.

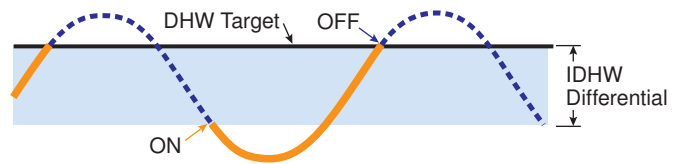

Boiler Target Temperature during a DHW Call

When a DHW Call is present, a boiler target is determined.

- When using a DHW Tank Aquastat, the boiler target is set to the IDHW Exchange setting.
- When using a DHW Tank Sensor, the boiler target is fixed at the IDHW Setpoint setting plus 40°F (22.0°C).
- When using a tekmarNet® Setpoint Control, the boiler target is set to the devices Exchange Supply setting.

If there are multiple devices calling for heat, the boiler target is set to the highest temperature requirement.

IDHW During UnOccupied

When using a DHW Tank Aquastat, a second IDHW Exchange setting is available for the UnOccupied or Sleep period.

When using a DHW Sensor, a second IDHW Setpoint setting is available for the UnOccupied or Sleep period.

DIP Switch must be set to Setback to view UnOccupied items. During the Away Scene, DHW Calls are ignored.

IDHW Mode

The control has a IDHW MODE setting that selects whether or not indirect DHW operation is active.

OFF

IDHW operation is inactive. All DHW Calls are ignored. If this mode is selected while DHW operation is underway, all DHW operation ceases.

ON

IDHW operation is active. All DHW Calls are responded to.

IDHW Location

The control has a IDHW Location setting that selects where the indirect DHW tank is located in the system. This setting determines the operating sensor & affects pump operation.

NEAR

The indirect DHW tank is piped in parallel within the near boiler piping of boiler 4. When a valid DHW Call is present, the IDHW Pump relay turns on & boiler pump 4 turns off. The control uses the boiler 4 outlet sensor as the operating sensor in order to measure the boiler supply temperature supplied to the indirect DHW tank. There are two boiler target temperatures. One for the space heating system (Boil TARG) & one for the indirect DHW system (IDHW TARG).

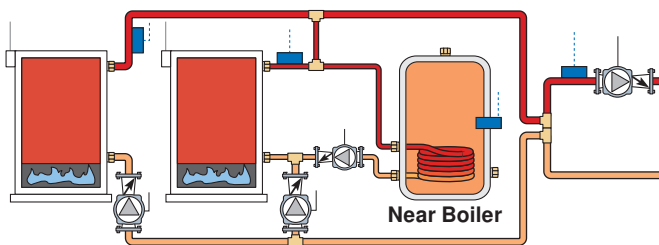

- All boilers are used for space heating requirements.
- Boiler 4 is used for indirect DHW when there is a DHW Call.
- The dedicated indirect DHW boiler is always boiler 4, even if there are less than four boilers.
- If boiler 4 is disabled & NEAR is selected for the IDHW Location, the dedicated indirect DHW boiler 4 will not operate.

Boil

The indirect DHW tank is piped in the boiler system loop. When a valid DHW Call is present, the IDHW Pump relay turns on.

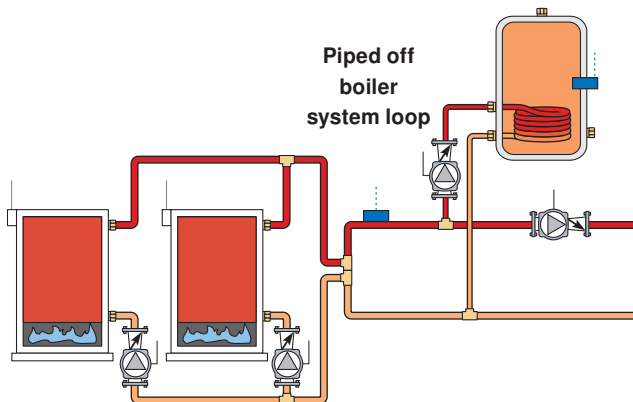

Primary Pump During IDHW

The control has a Primary Pump during IDHW setting that selects whether or not the primary pump is required during indirect DHW operation.

OFF

The primary pump does not turn on during indirect DHW operation. This would be typical of an indirect DHW tank piped in parallel in the boiler system loop. It is assumed that the DHW pump will provide adequate flow through the indirect DHW heat exchanger & the boiler system loop.

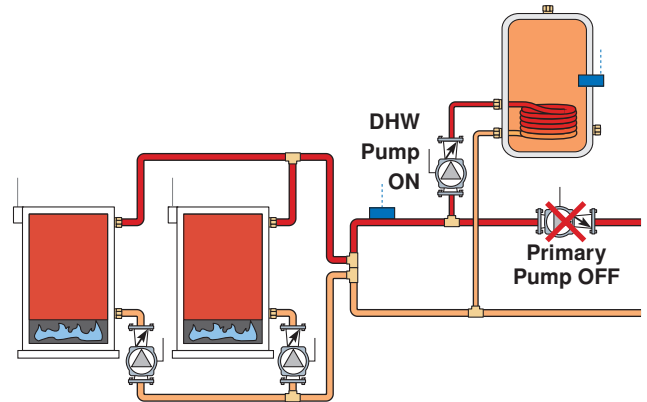

ON

The primary pump turns on during indirect DHW operation. This would be typical of an indirect DHW tank piped in primary/secondary in the boiler system loop.

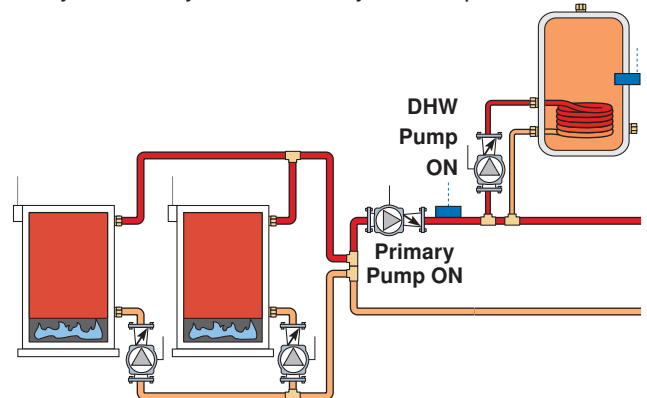

IDHW Priority

The control has a IDHW Priority setting that selects whether or not priority of indirect DHW is required over the space heating system. Indirect DHW priority stops or limits the delivery of heat to the space heating system while the indirect DHW tank calls for heat. This allows for quick recovery of the indirect DHW tank.

OFF

IDHW priority is not provided. The primary pump can operate when a Heat Call is present. Heating zones are unaffected by indirect DHW operation.

ON

IDHW priority is provided & is dependant on the type of space heating zones & whether or not the primary is required to operate during IDHW operation.

For non-tN4 space heating, the primary pump shuts off to provide priority. If the primary pump is required to operate for IDHW, priority requires the use of an external relay to force the heating zones off.

For tN4 space heating, the primary pump can operate when a Heat Call is present. If the boilers are unable to maintain the boiler target temperature, the tN4 zones are sequentially shut off using tN4 communication to provide priority.

Priority Override

Priority override applies when IDHW Priority is set to ON & prevents the building from cooling off too much or the possibility of a potential freeze up during IDHW priority.

When set to auto, the priority time is calculated based on outdoor temperature. At or below the design outdoor temperature, 15 minutes is allowed for IDHW priority. At or above the design indoor temperature, 2 hours is allowed for IDHW priority. The time allowed for IDHW priority varies linearly between the above two points. There is a manual setting also available in the Setup menu.

The priority timer does not start timing until priority is selected & both a DHW Call & a Heat Call exist together. Once the allowed time for priority has elapsed, the control overrides the DHW priority & resumes space heating.

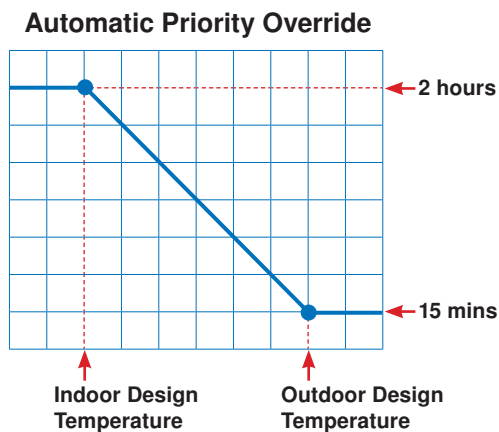

Conditional IDHW Priority

If the boiler supply temperature is maintained at or above the required temperature during IDHW operation, this indicates that the boilers have enough capacity for IDHW & possibly heating as well. As long as the boiler supply temperature is maintained near the target, IDHW & heating occurs simultaneously.

IDHW Post Purge

After the DHW Call is removed, the control performs a purge. The control shuts off the boilers & continues to operate the IDHW Pump & the primary pump if applicable. This purges the residual heat from the boilers into the DHW tank. The control continues this purge until one of the following occurs:

1. A Heat Call is detected.
2. The boiler supply drops 20°F (11.0°C) below the DHW target temperature.
3. The DHW tank temperature rises above the DHW setpoint plus 1/2 DHW Differential.
4. Two minutes elapse.

IDHW Mixing Purge

After IDHW operation, the boiler is extremely hot. At the same time, the heating zones may have cooled off considerably after being off for a period of time. When restarting the heating system after a DHW Call with priority, the control shuts off the boiler & continues to operate the IDHW pump while the primary pump is turned on. This allows some of the DHW return water to mix with the cool return water from the zones & temper the boiler return water.

IDHW with Low Temperature Boilers

If DHW heating is to be incorporated into a low temperature system such as a radiant floor heating system, a mixing device is often installed to isolate the high DHW supply temperature from the lower system temperature. If a mixing device is not installed, high temperature water could be supplied to the low temperature system while trying to satisfy the DHW Call. This may result in damage to the low temperature heating system.

The control is capable of providing IDHW heating in such a system while minimizing the chance that the temperature in the heating system exceeds the design supply water temperature. In order to do this, the following must be true:

- All available boilers are set to condensing.
- IDHW Location set to Boil.
- IDHW Priority set to ON.
- tN4 present (IF Primary Pump during IDHW operation is set to ON)

On a DHW Call, the control provides IDHW priority by sending a message on the boiler temperature bus to the tN4 thermostats to shut off the heating zones for a period of time. The length of time is based on the outdoor air temperature, or selectable time, as described in the IDHW Priority Override section. However, if the DHW Call is not satisfied within the allotted time, the boiler shuts off & the heat of the boiler is purged into the DHW tank. A IDHW mixing purge occurs in order to reduce the boiler water temperature & once the boiler supply temperature is sufficiently reduced, the IDHW Pump contact shuts off. The heating system zones are allowed to turn on for a period of time to prevent the building from cooling off. After a period of heating, & if the DHW Call is still present, the control shuts off the heating system & provides heat to the DHW tank once again.

IDHW Boil COUNT IDHW

Selects the number of boilers to be used for IDHW operation. This applies when only there is a requirement for IDHW. All available boilers are allowed to operate if there is both a requirement for space heating & IDHW.

Dedicated Domestic Hot Water (DDHW) Operation

The control can operate to provide heat for a Dedicated Domestic Hot Water (DDHW) system.

DDHW heating is available by setting the Application Mode in the Setup Menu to DDHW.

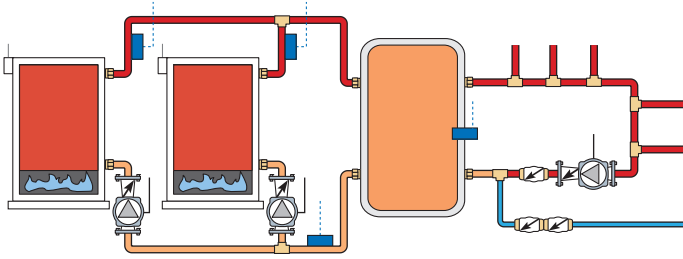

DHW Call

A DHW Call is required in order for the control to provide heat to a dedicated DHW tank. Once the control registers a DHW Call, it will display the “DHW” icon under Calls in the display. This can be done by:

DHW Sensor

The control can register a DHW Call when a DHW Sensor is wired to terminals 21 & 22. Once the DHW Sensor temperature drops 1/2 of the DDHW Differential setting below the DDHW Setpoint, the control registers a DHW Call.

DDHW Differential

A DHW Call is registered when the temperature at the DHW sensor drops the DDHW DIFF setting below the DDHW Setpoint setting. The DHW Call is satisfied once the temperature at the DHW Sensor rises to the DDHW Setpoint setting.

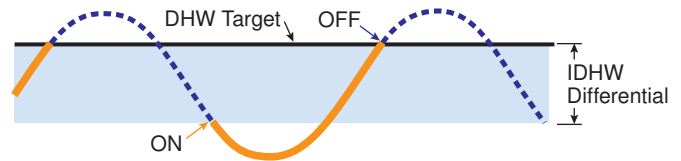

Boiler Target Temperature During a DDHW Call

When a DHW Call is present, a boiler target is determined. The boiler target is set to the DDHW Setpoint setting.

DDHW During UnOccupied

A second DDHW Setpoint setting is available for the UnOccupied periods.

DIP Switch must be set to Setback to view UnOccupied items.

During the Away Scene, DHW Calls are ignored.

Building Automation System (BAS)

The control can communicate with a Building Automation System (BAS) to provide remote monitoring & adjustment capability.

BAS Mode

There are two modes of BAS communication that define the interaction between the BAS & the control. The level of interaction is determined by the Application Mode setting.

Refer to the BAS Integration Manual 284_B for more information including a listing of the read / write parameters.

Monitor

Monitor mode is available when the Application Mode is set to either Outdoor Temperature Reset, Setpoint, Dedicated Domestic Hot Water (DDHW) or Energy Management System (EMS).

With Monitor mode, the control allows for viewing & adjustment capability of select items within the various menus.

Temperature

Temperature mode is available when the Application Mode is set to Building Automation System (BAS).

With Temperature mode, the control operates to maintain the setpoint temperature provided over the BAS network. In order for the control to be able to operate to maintain the BAS Setpoint, the BAS must also write a Setpoint Call command over the BAS network.

If primary pump operation is desired, the BAS must write a BAS Primary Pump command over the BAS network.

If indirect DHW pump operation is desired, the BAS must write a BAS IDHW Pump command over the BAS network.

BAS Type

The control supports Modbus® & BACnet® IP communications. Selection is made through BAS TYPE item in the BAS menu. If the control is not being connected to a BAS network, select NONE.

Network Configuration Settings in BAS Menu

Refer to the BAS menu section of this brochure for a listing of all the BAS network configuration settings.

Pump Operation

Primary Pump Operation

The control includes two primary pump outputs with capability for sequencing. There is pump enable setting for each primary pump in the Setup menu. When both primary pumps are set to Auto, primary pump sequencing is activated. Primary pump 1 & 2 are operated in stand-by mode when pump sequencing is activated.

The running times of the primary pumps are logged in the Monitor Menu. To reset these values back to zero, select "Clear" while viewing this item.

Operation of the primary pump(s) is determined from the Application Mode & the presence of an appropriate call.

Application Mode: Outdoor Temperature Reset (RSET)

- Heat Call from Contact Closure.
- Heat Call from tN4 Device & that zone's thermostat has H1 Pump set to On. tN4 thermostats also include a thermal actuator setting which can delay the primary pump for 3 minutes to allow thermal actuators to open.
- Setpoint Call from Contact Closure & Primary Pump during Setpoint operation set to ON.
- DHW Call & the Primary Pump during IDHW operation set to ON.

Application Mode: Setpoint (SETP)

- Setpoint Call from Contact Closure & Primary Pump during Setpoint operation set to ON.
- DHW Call & the Primary Pump during IDHW operation set to ON.

Application Mode: Energy Management System (EMS)

- Heat Call from Analog Input Signal.
- DHW Call & the Primary Pump during IDHW operation set to ON.
- Setpoint Call from Contact Closure & Primary Pump during Setpoint operation set to ON.

Application Mode: Building Automation System (BAS)

- BAS Setpoint Pump Call.

Flow Proof Call

The control includes a flow proof call in order to prove flow once a primary pump has turned on. In order for boiler plant operation to commence, the proof call must be present. A flow proof call is required at all times during pump operation.

Once a primary pump contact is turned on, a flow proof call must be present before the flow proof delay has expired.

The flow proof call feature is enabled by setting the DIP switch to the External Flow Proof position.

The flow proof call feature can only be used when the control is configured to operate the primary pump for all loads.

If there are multiple loads (e.g. Heat Call and DHW Call) and the primary pump is disabled for DHW operation, then the control cannot provide flow proving and the feature must be disabled. In this case, the flow proof feature must be obtained through another control such as the Pump Sequencer 132.

A flow proof call can be provided in two ways:

Contact Closure

A dry contact or 24 V (ac) signal is applied across the Flow Proof Call terminals 1 & 2.

A contact closure can come from a flow switch, pressure differential switch, current sensing or power sensing device.

ΔP	Pressure Differential Switch
FS	Flow Switch
KW	Power Sensing Device
Amp	Current Sensing Device

Analog Flow Sensor

A 4-20 mA style flow sensor can be used to both monitor & prove flow. The Flow Sensor item in the Setup Menu must be set to ON to enable the flow sensor to provide monitoring. The Flow Rate 4 mA and Flow Rate 20 mA items in the Setup Menu configure the flow range for the flow sensor being used.

To enable the flow proof feature, the Flow Proof item in the Setup Menu must be set to a flow percentage. The flow percentage is the percentage of full flow (dependant on the configured flow range) that must be achieved within the flow proof delay time to prove flow. If the flow sensor is not required to prove flow, the Flow Proof item must be set to OFF.

Stand-by Operation

The control only operates one primary pump at a time. A flow proof device can be used to detect when stand-by pump operation is required.

- When an appropriate Call is registered, the lead pump is activated, & the control waits for flow to be established within the flow proof delay time.
- If no flow is established, the lead pump is de-activated, the lag pump is activated & the control waits again for the flow to establish within the flow proof delay time.
- If no flow is established with the lag pump, the control will make a second attempt to prove flow with the pumps, starting with the lead pump. If flow cannot be proved after the second attempts, the control stops operation until the error is cleared. Verify that the pumps & flow proof device are working correctly before clearing the error.
- If the lead pump establishes flow, & fails during operation, the lag pump is activated.
- If at any time, one or both pumps fail to prove flow, an error message is displayed.

Normal Operation

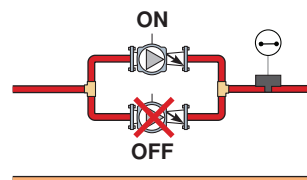

Stand-by Pump Operation

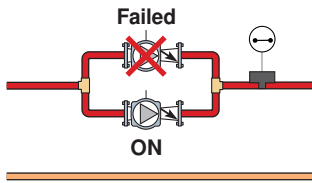

Flow Proof Delay

The control waits a period of time to receive a flow proof call from the time the primary pump turns on. If the control does not receive a flow proof call within that period of time, the primary pump turns off & the stand-by primary pump (if active) turns on. The control then waits that period of time again for the stand-by primary pump to prove flow. If flow is not proven, the stand-by pump turns off. The period of time is set through the FLW PROOF item in the Setup menu & it is adjustable between 10 seconds & 3 minutes.

Flow Proof Demand Test

The control includes a flow proof demand test in order to determine if the flow/pressure device has failed. A flow proof failure is detected if a flow proof call is present after the pumps have been shut off for more than four minutes. This can occur if the flow proof device sticks in the on position even when flow has stopped in the system. A flow proof call error will latch when this condition exists.

Primary Pump Rotation

The control rotates the pumps based on the primary pump Rotate item in the Setup menu. Frequency of Rotation is based on the running time of the pumps. Rotation is done when the lead pump is off. If the lead pump runs continuously, the rotation is delayed for up to 12 hours. If the pump runs continuously & rotation is required, the control shuts off the lead pump & 1 second later the stand-by pump is turned on. This eliminates overloading the pump electrical circuit. Upon turning on the stand-by pump the flow proof call input is checked after the flow proof call delay time.

Primary Pump Purge

After the last valid call is removed, the primary pump is operated for an additional period of time. If the last call came from a tN4 zone, the control sends out a purge message to override the zone open for the duration of the boiler purge. At the end of the purge, the zone override is removed so the zone is allowed to close & turn off the primary pump. If the last call came from a non-tN4 zone, the purge period for the primary pump is adjustable between 10 seconds & 20:00 minutes.

Boiler Pump / Valve Operation

The control includes relays to operate the boiler pumps / valves.

The control includes a boiler pre-purge which operates the respective pump / valve for a period of time before the boiler is ignited in order to purge potential residual heat out of the boiler. For isolation valves, this time also allows for the valve to spring open prior to boiler ignition. For pumps, the time is determined from the boiler mass setting. As the boiler mass setting is increased, the time is also increased. For DHW and Setpoint Calls, to help reduce boiler pick-up times, the time

is fixed at 4 seconds. For isolation valves, the time is always fixed at 30 seconds.

The control includes a boiler post-purge feature that operates the respective pump / valve for a period of time after the boiler is turned off. This feature will purge heat out of the boiler & aid in reducing "kettling". The amount of time for the boiler post-purge is adjustable between 10 seconds & 20:00 minutes. The period of time is adjustable through the boiler post-purge setting in the Source (#) Menu.

Indirect DHW (IDHW) Pump Operation

The control includes a relay to operate an indirect DHW pump.

Operation of the IDHW pump is determined by the Application Mode & the presence of an appropriate call.

Application Mode: Outdoor Temperature Reset, Setpoint, Energy Management System

- DHW Call from Contact Closure.
- DHW Call from DHW Sensor.
- DHW Call from tekmarNet® Setpoint Control with Sensor.

Application Mode: Building Automation System

- BAS DHW Pump Call.

DHW Recirculation Pump Operation

The control has the capability to operate a DHW Recirculation Pump when the control is configured for either Indirect Domestic Hot Water (IDHW) or Dedicated Domestic Hot Water (DDHW). IDHW is available when the application mode is set to either outdoor temperature reset, setpoint or EMS. DDHW is available when the applicable mode is set to DDHW. The Aux Relay setting in the Setup Menu must be set to DHWR to enable the DHW recirculation pump.

The DHW recirculation pump operates continuously during the Occupied period. If setback is enabled, the pump operates when heat is required during the Unoccupied period.

Combustion Air (C.A.) Damper & DHW Recirculation Pump Settings

Auxiliary Relay

The control includes an auxiliary relay that can be used either for a combustion / venting device or a DHW recirculation pump. Selection is made through the AUX RELAY item in the Setup menu. Off is also available if there is no Auxiliary device.

DHW Recirculation Pump

When the Aux Relay is set to DHWR, terminals 43 & 44 operate a domestic hot water (DHW) recirculation pump. Refer to the Pump Operation section of this brochure for a description of the DHW recirculation pump operation.

Combustion Air Damper

When the Aux Relay is set to DMPPR, terminals 43 & 44 operate a combustion air damper / fan motor or power vent motor. The relay closes once an appropriate call (e.g. Heat) is received & the control has determined that one or more boilers need to be turned on.

Combustion Air (C.A.) Proof Call

The C.A. Proof Call is used to prove a combustion air or venting device. Boiler operation cannot occur until the proof call is present. If the proof call is lost during operation, the boiler plant is sequenced off.

Once the DMPPR contact is turned on, a C.A. proof call must be present before the C.A. proof delay has expired.

The C.A. proof call feature is enabled by setting the DIP switch to the External C.A. Proof position.

A C.A. proof call can be provided by:

Contact Closure

A dry contact or 24 V (ac) signal is applied across the C.A. Proof Call terminals 3 & 4.

Combustion Air Proof Delay

The control includes a time delay that is associated with the C.A. proof call feature in order to determine if the proof device is functional. Once the DMPPR relay closes, the control allows for this time delay to receive the C.A. proof call. If the C.A. proof call is not received within the delay time, the control will display an error message.

Combustion Air (C.A.) Proof Call Test

The control includes a C.A. proof call test in order to determine if the proving device has failed. If the DMPPR relay is opened, the C.A. proof call should not be present after 4 minutes. If the C.A. proof call remains, the control will display an error message.

Combustion Air Delay

If the C.A. proof call feature is set to OFF (DIP switch), sequencing only occurs once a user adjustable time delay elapses.

Combustion Air Post Purge

There is a fixed 15 second post purge of the C.A. relay after the last boiler has turned off, or the appropriate call (e.g. Heat) is removed. If there is a call still present once the last boiler has turned off, the control can look at the error & determine if sequencing is to occur in a "short" period of time. If the control does anticipate staging, the DMPPR relay will remain on. Otherwise, the DMPPR relay will be turned off once the 15 second post purge elapses.

Setting the Schedule

To provide greater energy savings, you can operate the control on a programmable schedule. The schedule is stored in memory & is not affected by loss of power to the control. If a tN4 network is detected the control can become either a schedule member or schedule master.

Control (CTRL) Schedule (tN4 present)

The schedule only applies to the control. The control follows its own schedule & the events are not communicated to tN4 thermostats.

Master Schedule (tN4 present)

If the control is connected to tN4 thermostats, then the control can operate on a master schedule. You can set up a maximum of four master schedules on the tN4 Network. A master schedule is available to all devices on the tN4 network. Master schedules simplify installation since one master schedule may be used by multiple devices.

To create a master schedule:

- Assign the control to be a schedule master by setting the Heat Schedule item in the Schedule menu to Master (MST) 1 to 4. After a master schedule is selected, a clock symbol will appear in the View menu display.

The 284 Setback / Off DIP Switch must be set to Setback to access the Schedule Menu.

To follow a master schedule:

- Assign the control to follow a master schedule by setting the Heat Schedule in the Schedule menu to Member (MBR) 1 to 4.

Schedule Types

The schedule type determines when the schedule repeats itself. This control includes four different schedule types:

- 24 Hour: Repeats every 24 hours.
- 5-2: Repeats on a weekly basis. However, it breaks the week into weekend followed by the weekdays. This reduces the amount of schedule event settings.
- 5-11: Repeats on a weekly basis. However, it breaks the weekend into Saturday & Sunday followed by the weekdays. This reduces the amount of schedule event settings.
- 7 Day: Repeats on a weekly basis & allows for separate event times for each day.

Day	Schedule Type			
	24 Hour	5-2	5-11	7 day
Saturday	•	•	•	•
Sunday			•	•
Monday				•
Tuesday				•
Wednesday			•	•
Thursday				•
Friday				•

Events / Day

The events / day can be either 4 or 2. An event is a time at which the control changes the target temperature. The event time can be set to the nearest 10 minutes. If you wish to have the thermostat skip the event, enter "--:--" as the time. The "--:--" time is found between 11:50 PM & 12:00 AM. See the table, Events / Day, for more details regarding types of events.

Events / Day	Event	24Hr	Sat	Sun	Mon	Tue	We	Thu	Fri
4 events per day	Occupied 1	6:00 AM	6:00 AM	6:00 AM	6:00 AM	6:00 AM	6:00 AM	6:00 AM	6:00 AM
	UnOccupied 1	8:00 AM	8:00 AM	8:00 AM	8:00 AM	8:00 AM	8:00 AM	8:00 AM	8:00 AM
	Occupied 2	6:00 PM	6:00 PM	6:00 PM	6:00 PM	6:00 PM	6:00 PM	6:00 PM	6:00 PM
	UnOccupied 2	10:00 PM	10:00 PM	10:00 PM	10:00 PM	10:00 PM	10:00 PM	10:00 PM	10:00 PM
or									
2 events per day	Occupied	6:00 AM	6:00 AM	6:00 AM	6:00 AM	6:00 AM	6:00 AM	6:00 AM	6:00 AM
	Unoccupied	10:00 PM	10:00 PM	10:00 PM	10:00 PM	10:00 PM	10:00 PM	10:00 PM	10:00 PM

Time Clock

The control has a built-in time clock to allow the control to operate on a schedule. A battery-less backup allows the control to keep time for up to 4 hours without power. The time clock supports automatic adjustment for Daylight Saving Time (DST) once the day, month, & year are entered. Use the Time menu to set the correct time, day, month, & year.

The Setback / Off DIP Switch must be set to Setback before the Time menu can be accessed.

tekmarNet®4 Communication

The 284 can communicate with tekmarNet® Thermostats, Wiring Centers & Setpoint Controls to maximize system efficiency & comfort. The 4 tN4 bus connections on the 284 use the boiler water temperature. No mix temperatures are available to the 284. tekmarNet® Thermostats enable the Indoor Temperature Feedback feature on the 284. This allows water temperatures to be adjusted to compensate for both indoor & outdoor temperatures. Each bus can include up to 24 devices, providing a total of 96 on the tekmarNet® network.

Cycle Length Setting in Adjust Menu (tN4)

The control includes an adjustment for the cycle length. The cycle length adjustment allows for synchronization of tN4 zones. An Auto setting allows for the cycle length to be automatically calculated to balance equipment cycling & comfort.

In the tekmarNet®4 system, all of the tekmarNet®4 Thermostats determine the best cycle length for their zone. The thermostats look at trying to maintain the longest possible cycle length while keeping temperature swings to a minimum. The Thermostats do this every cycle & send their ideal cycle length time to the 284. In order to operate the system as efficiently as possible, all of the zones must operate based on the same cycle. In order to do this, the 284 listens to all of the cycle length requests from all of the tekmarNet®4 Thermostats. The 284 then determines the average cycle length & sends this information to all of the tekmarNet®4 Thermostats, allowing them to operate on the same cycle.

Indoor Temperature Feedback (tN4)

Indoor feedback applies when the 284 is connected to a tN4 Thermostat network operating on a boiler bus. Indoor temperature feedback fine tunes the water temperature of the system based on the requirements of the thermostats. Each thermostat tells the tN4 System Control the water temperature that it requires to heat its zone.

Device Count (tN4)

The control includes a device count of all the tN4 devices connected to each of the four buses. This item is always found in the Toolbox Menu called BUS(#) DEV. Use this to confirm that the correct number of devices are connected to the boiler bus.

Scenes

The 284 will respond to the following tekmarNet® scenes:

Scene	Response
1	Occupied or Schedule
2	Away, operates Room at 62°F (16.5°C) & there is no DHW heating
3	Permanent Unoccupied
4	Occupied or Schedule
5	Occupied or Schedule
6	Temporary 3 hour Occupied
7	Temporary 3 hour Occupied
8	Temporary 3 hour Occupied

Important Safety Information

⚠ WARNING



It is your responsibility to ensure that this control is safely installed according to all applicable codes and standards. tekmar is not responsible for damages resulting from improper installation and/or maintenance.

To avoid serious personal injury and damage to the equipment:



- Read Manual and all product labels BEFORE using the equipment. Do not use unless you know the safe and proper operation of this equipment.
- Keep this Manual available for easy access by all users.
- Replacement Manuals are available at tekmarControls.com



- Disconnect all power before opening the control.

- It is the installers responsibility to ensure that this control is safely installed according to all applicable codes and standards.
- Improper installation and operation of this control could result in damage to the equipment and possibly even personal injury or death.
- This electronic control is not intended for use as a primary limit control. Other controls that are intended and certified as safety limits must be placed into the control circuit.
- Do not attempt to service the control. There are no user serviceable parts inside the control. Attempting to do so voids warranty.

Installation

Radio Frequency Interference

The installer must ensure that this control & its wiring are isolated &/or shielded from strong sources of electromagnetic noise. Conversely, this Class B digital apparatus complies with Part 15 of the FCC Rules & meets all requirements of the Canadian Interference-Causing Equipment Regulations. However, if this control does cause harmful interference to radio or television reception, which is determined by turning

the control off & on, the user is encouraged to try to correct the interference by re-orientating or relocating the receiving antenna, relocating the receiver with respect to this control, &/or connecting the control to a different circuit from that to which the receiver is connected.

Cet appareil numérique de la classe B respecte toutes les exigences du Règlement sur le matériel brouilleur du Canada.

Installation Location

When choosing the location for the control, consider the following:

- Keep dry. Avoid potential leakage onto the control.
RH ≤ 90% to 104°F (40°C).
Non-condensing environment.
- Do not expose to operating temperatures beyond 32-104°F (0-40°C)
- Provide adequate ventilation.
- Keep away from equipment, appliances or other sources of electrical interference.

- Provide easy access for wiring, viewing, & adjusting the display screen.
- Mount approximately 5 ft. (1.5 m) off the finished floor.
- Locate the control near pumps &/or zone valves if possible.
- Provide a solid backing to mount the enclosure to. For example: plywood, studs, etc
- Use the conduit knockouts provided on the upper, lower, back & sides of the enclosure.

Figure 1

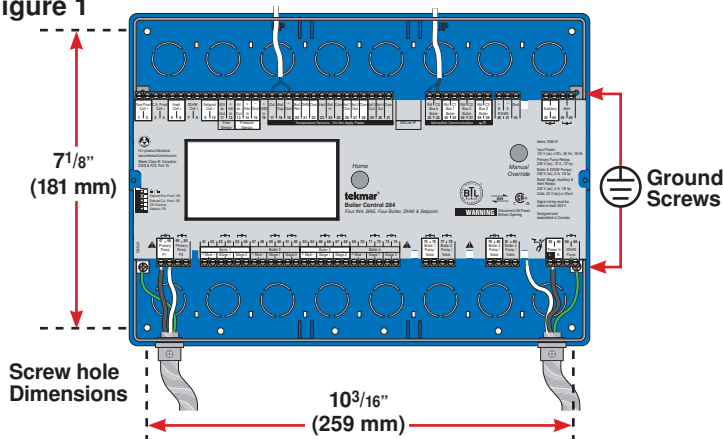
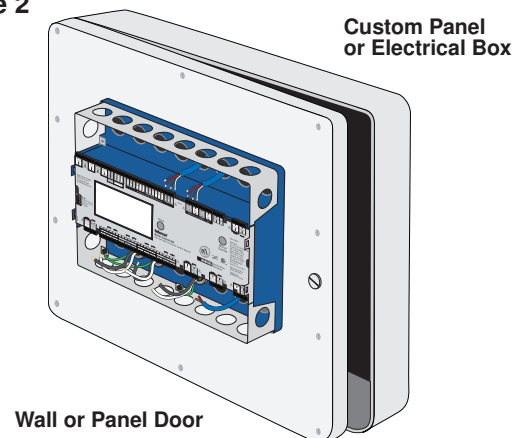

Figure 2



Control Wiring

⚠ This section explains how to wire individual devices to the Boiler Control 284. For step by step wiring refer to the terminal number on the right of the page.

⚠ WARNING

- Before wiring, ensure all power is turned off & take all necessary precautions.
- Install the supplied wiring compartment barriers by sliding them into the grooves provided to isolate the low & high voltage wiring.
- Strip all wiring to a length of 3/8 in. or 10 mm for all terminals.
- A circuit breaker or power disconnect that provides power to the control should be located nearby & clearly labeled.
- Refer to the current & voltage ratings at the back of this brochure before connecting devices to this control.
- Only qualified personnel should install or service the control.

⚠ Wiring the Input Power

Terminals 83, 84

Provide a 15 Amp circuit for the input power.

- Connect the 115 V (ac) line wire (L) to terminal 83.
- Connect the neutral wire (N) to terminal 84.
- Connect the ground wire (G) to one of the ground screws provided in the wiring chamber.

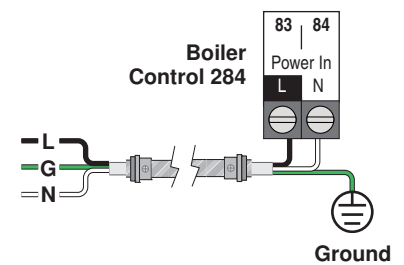

⚠ Wiring the Primary Pumps

Terminals 47 to 50

Primary pumps requiring up to 230 V (ac) 10 A, 1/2 hp can be switched through terminals 47, 48 & 49, 50. If a single power source is used for multiple pumps, ensure they are not tied together at any point between the pumps & the control. For simplicity in wiring & troubleshooting, a separate breaker for each pump is recommended.

- For Primary Pump P1 connect the power source line wire (L) to terminal 47.
- Connect a wire from terminal 48 to the pump L.
- Connect a wire from the pump N back to the power source neutral.
- For Primary Pump P2 connect the power source line wire (L) to terminal 49.
- Connect a wire from terminal 50 to the pump L.
- Connect a wire from the pump N back to the power source neutral.
- Ensure grounds are connected in the pump & control wiring chambers.

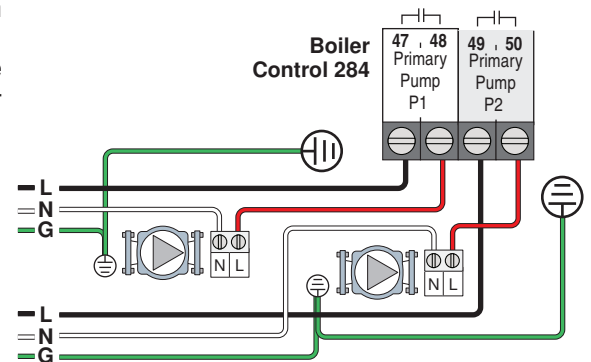

⚠ Wiring the Boiler Pumps / Valves

Terminals 75 to 82

Boiler pumps / valves requiring up to 230 V (ac) 5 A, 1/3 hp can be switched through terminals 75 to 82. If a single power source is used for multiple pumps, ensure they are not tied together at any point between the pumps & the control. For simplicity in wiring & troubleshooting, a separate breaker for each pump is recommended.

- For the Boiler 1 Pump / Valve connect the power source line wire (L) or low voltage (R) to terminal 75.
- Connect a wire from terminal 76 to the device L or R (low voltage).
- Connect the N or C (low voltage) back to the power source neutral.
- Repeat for additional pumps using the Boiler 2 Pump / Valve to Boiler 4 Pump / Valve terminal sets (77 & 78), (79 & 80) & (81 & 82).
- Ensure grounds are connected in the pump/valve & control wiring chambers.

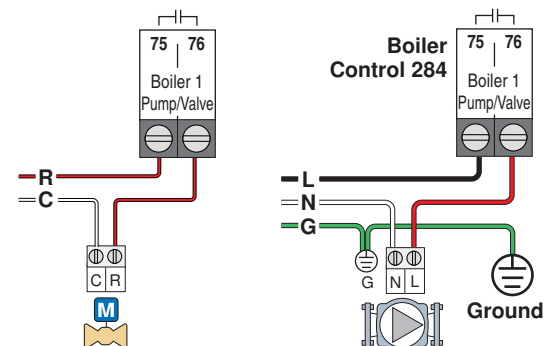

⚠ Wiring an Indirect DHW Pump

Terminals 85, 86

An indirect DHW pump requiring up to 230 V (ac) 5 A, 1/3 hp can be switched through the IDHW Pump terminals.

- Connect the line wire (L) to terminal 85.
- Connect a wire from terminal 86 to the pump L.
- Connect a wire from the pump N back to the power source neutral.
- Ensure grounds are connected in the pump & control wiring chambers.

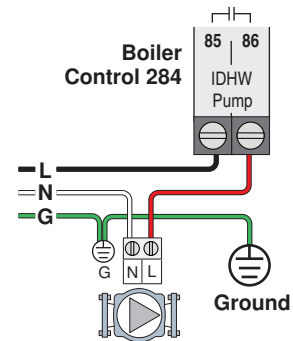

⚠ Wiring a Combustion Air (C.A.) Damper / DHW Recirculation Pump

Terminals 43, 44

A C.A. damper or DHW recirculation pump requiring up to 230 V (ac) 5 A, 1/6 hp can be switched through the Auxiliary terminals.

- Connect the line wire (L) or R (low voltage) to terminal 43.
- Connect a wire from terminal 44 to the L or R on the auxiliary device.
- Connect the N (line voltage) or C (low voltage) back to the power source neutral.
- Ensure grounds are connected in the pump & control wiring chambers.

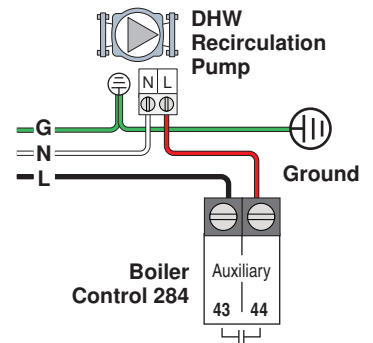
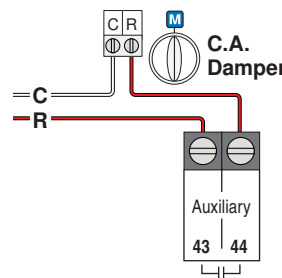

⚠ Wiring an Alert

Terminals 45, 46

An Alert Device requiring up to 230 V (ac) 5 A, 1/6 hp can be switched through the Alert terminals to provide notification of specific system events.

- Connect the line wire L (line voltage) or R (low voltage) to terminal 46.
- Connect a wire from terminal 45 to L or R on the alert device.
- Connect the N (line voltage) or C (low voltage) back to the power source neutral.

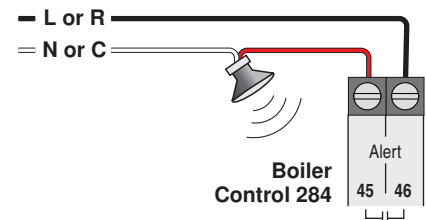

⚠ Wiring a Flow Proof

Terminals 1, 2

The 284 requires a closed switch or short for proof of flow. Up to 24 V (ac) can be passed through the switch. If a flow proof device is being used, ensure the External Flow Proof / Off DIP switch on the front of the control is set to the External Flow Proof position.

- Connect the Flow Proof Call terminals 1 & 2 to the flow proof device.

If a flow sensor is being used as the flow proving device, a jumper must be placed across the flow proof call terminals.

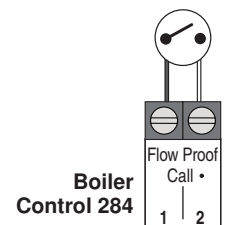

⚠ Wiring a Combustion Air (C.A.) Proof

Terminals 3, 4

The 284 requires a closed switch or short for proof of combustion air. Up to 24 V (ac) can be passed through the switch. If a combustion air proof device is being used, ensure the External C.A. Proof / Off DIP switch on the front of the control is set to the External C.A. Proof position.

- Connect the C.A. Proof Call terminals 3 & 4 to a combustion air proof.

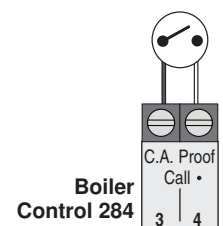

⚠ Wiring a Heat Call

Terminals 5, 6

The 284 requires a switched external heat call to operate the boiler plant unless calls for heat are generated through a tekmarNet® device, EMS, BACnet® or Modbus® connection. The heat call can be volt free or up to 24 V (ac).

- Connect the Heat Call terminals 5 & 6 to a switched heat demand.
- Typical heat calls are from a zone relay box or thermostat.
- A permanent heat call can be created by installing a jumper wire between terminals 5 & 6.

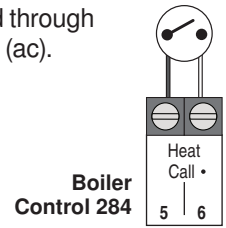

⚠ Wiring an Indirect DHW (IDHW) Call

Terminals 7, 8

If the DHW sensor option is not used, a call for indirect domestic hot water can come from an aquastat connected to terminals 7 & 8. The IDHW Call can be volt free or up to 24 V (ac).

- Connect the IDHW Call terminals 7 & 8 to the DHW tank aquastat.

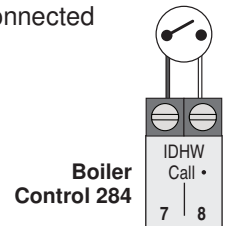

⚠ Wiring a Setpoint Call

Terminals 9, 10

The Setpoint Call terminals 9 & 10 can receive a call for heat from a setpoint control or thermostat. The setpoint call can be volt free or up to 24 V (ac).

- Connect the Setpoint Call terminals 9 & 10 to the output terminals on a setpoint control or thermostat.

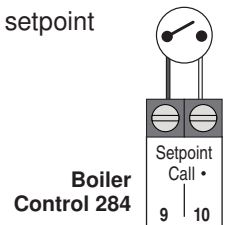

⚠ Single Stage Boiler Wiring

Terminals 53 to 72

A single stage condensing or non-condensing boiler is enabled through the T T contacts.

- For Boiler 1 connect Stage 1 terminals 53 & 54 to the boiler TT contacts.
- For Boiler 2 connect Stage 1 terminals 59 & 60 to the boiler TT contacts.
- For Boiler 3 connect Stage 1 terminals 65 & 66 to the boiler TT contacts.
- For Boiler 4 connect Stage 1 terminals 71 & 72 to the boiler TT contacts.

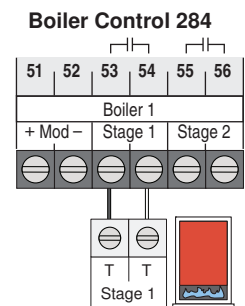

⚠ Two Stage Boiler Wiring

Terminals 53 to 74

A two stage condensing or non-condensing boiler requires two wires for each stage.

- For Boiler 1 connect Stage 1 terminals 53 / 54 & 55 / 56 to the boiler stage 1 & stage 2 contacts.
- For Boiler 2 connect Stage 1 terminals 59 / 60 & 61 / 62 to the boiler stage 1 & stage 2 contacts.
- For Boiler 3 connect Stage 1 terminals 65 / 66 & 67 / 68 to the boiler stage 1 & stage 2 contacts.
- For Boiler 4 connect Stage 1 terminals 71 / 72 & 73 / 74 to the boiler stage 1 & stage 2 contacts.

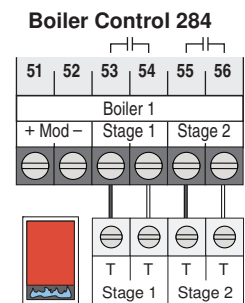

⚠ Modulating Boiler Wiring

Terminals 51 to 72

For modulating boilers that do not require an enable:

- The 284 provides either a 4-20 mA or a 0-10 V (dc) output to each boiler.
- Polarity is important.
- Connect the Mod + terminals from boilers 1, 2, 3 and 4 to the 284 terminals 51, 57, 63 and 69, respectively.
- Connect the Mod - terminals from boilers 1, 2, 3 and 4 to the 284 terminals 52, 58, 64 and 70, respectively.

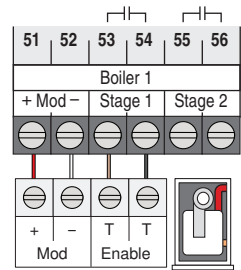

Some modulating boilers may also require an on / off signal in addition to the modulating signal. See the Stage 1 terminals for boilers 1, 2, 3 and 4.

The 4 to 20 mA output can be converted to a 0 - 135 Ω output for a Modutrol IV™ gas valve actuating motor using a 0 - 135 Ω tekmar Converter 005 (sold separately).

The 4 to 20 mA output can be converted to a 0 - 135 Ω output for a V9055™ gas valve actuating motor using a 0 - 135 Ω tekmar Converter 005 (sold separately).

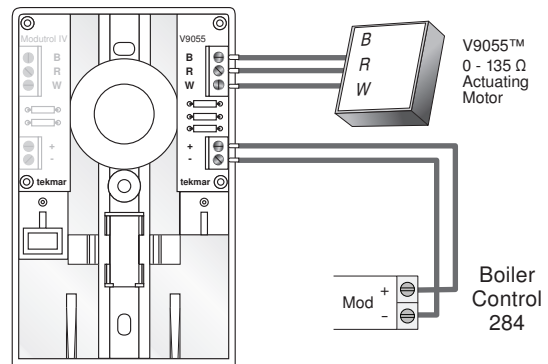
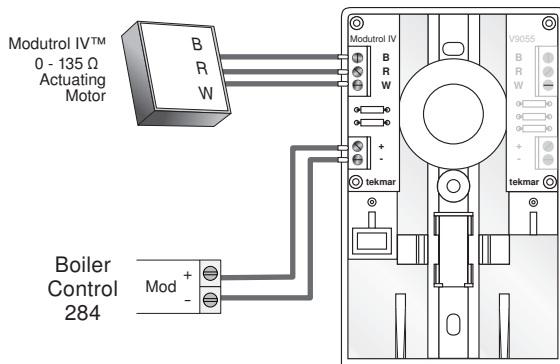

Modutrol IV™ and V9055™ are trademarks of Honeywell, Inc.

Sensor Installation & Wiring

Mounting the Outdoor Sensor

The temperature sensor (thermistor) is built into the sensor enclosure.

- Remove the screw & pull the front cover off the enclosure.
- The sensor can either be mounted directly onto a wall or a 2" x 4" electrical box. When the sensor is wall mounted, the wiring should enter through the back or bottom of the enclosure. Do not mount the sensor with the conduit knockout facing upwards as rain could enter the enclosure & damage the sensor.

- In order to prevent heat transmitted through the wall from affecting the sensor reading, it may be necessary to install an insulating barrier behind the enclosure.
- The Outdoor Sensor should be mounted on a wall which best represents the heat load on the building (a northern wall for most buildings & a southern facing wall for buildings with large south facing glass areas). The sensor should not be exposed to heat sources such as ventilation or window openings.
- The sensor should be installed at an elevation above the ground that will prevent accidental damage or tampering.

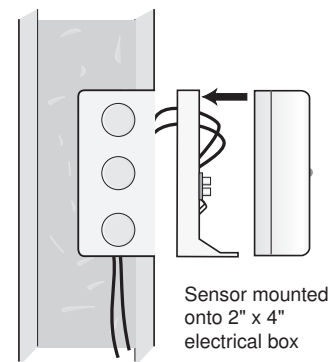
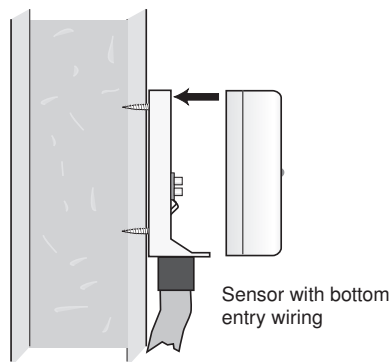
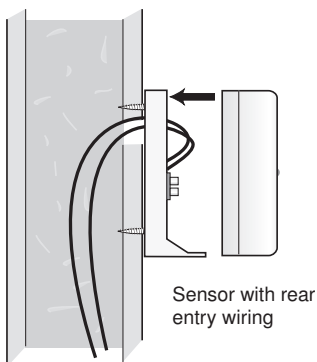

- Connect 18 AWG or similar wire to the two terminals provided in the enclosure & run the wires from the sensor to the control. Do not run the wires parallel to telephone or power cables. If the sensor wires are located in an area with strong sources of electromagnetic interference (EMI), shielded cable or twisted pair should be used or the wires can be run in a grounded metal conduit. If using shielded cable, the shield wire should be connected to the Com terminal on the control & not to earth ground.
- Replace the front cover of the sensor enclosure.
- Connect one wire from the outdoor sensor to the Out terminal 17 on the 284.

- Connect the second wire to the Com terminal 19.

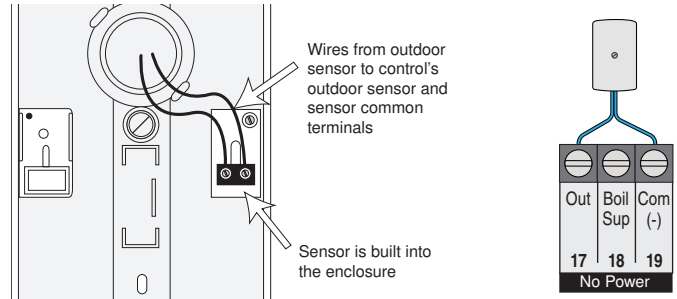

Mounting the Universal Sensors

These sensors are designed to mount on a pipe or in a temperature immersion well.

The Universal Sensor should be placed downstream of a pump or after an elbow or similar fitting. This is especially important if large diameter pipes are used as the thermal stratification within the pipe can result in erroneous sensor readings. Proper sensor location requires that the fluid is thoroughly mixed within the pipe before it reaches the sensor.

Strapped to Pipe

The Universal Sensor can be strapped directly to the pipe using the cable tie provided. Insulation should be placed around the sensor to reduce the effect of air currents on the sensor measurement.

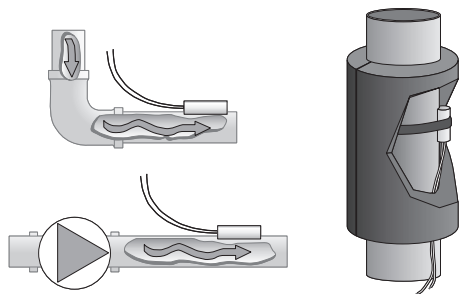

Immersion Well

If a Universal Sensor is mounted onto 1" (25 mm) diameter L type copper pipe, there is approximately an 8 second delay between a sudden change in water temperature & the time the sensor measures the temperature change. This delay increases considerably when mild steel (black iron) pipe is used. In general, it is recommended that a temperature well be used for steel pipe of diameter greater than 1-1/4" (32 mm). Temperature wells are also recommended when large

diameter pipes are used & fluid stratification is present. If the well is not a snug fit on the sensor tube, use the heat transfer paste supplied with the product. Apply paste to the sides of the sensor and place a pea-sized globule on the sensor tip. Push the sensor into the well and when it bottoms out, press firmly. The paste will be forced up the sides of the well.

Conduit Connection

The Universal Sensor & Universal Sensor Enclosure 080 (sold separately) are specifically designed to mount onto a 3/8" (10 mm) ID temperature well that is supplied with an end groove. To install the well, plumb a 'T' into the pipe & fix the well into the 'T'. The 080 enclosure has a 7/8" (22 mm) back knockout that must be removed & fitted over the temperature well. The Universal Sensor is then inserted into the well & the retaining clip supplied with the enclosure is snapped onto the well end groove. If the well has a threaded end, the installer must supply a standard threaded conduit retaining ring. The two wires from the sensor are connected to the terminal block provided in the enclosure. The other side of the terminal block is used to connect wires from the control.

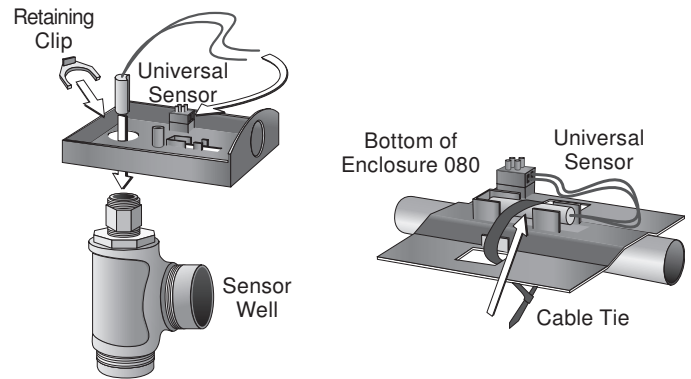

Wiring Boiler Outlet Sensors (tekmar 082)

Up to 4 boiler outlet sensors can be wired to the 284. These connections are not polarity sensitive.

- Connect one wire from the outlet sensor for boiler 1 to the Boil 1 Out terminal 26.
- Connect the second wire from the outlet sensor for boiler 1 to the Com terminal 28.
- Repeat for additional boiler outlet sensors using terminal sets 27 & 28, 29 & 31, 30 & 31.

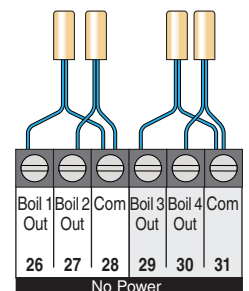

Wiring a Boiler Inlet Sensor (tekmar 082)

Terminals 24, 25

A single boiler inlet sensor measures the water temperature entering the boilers.

- Connect one wire from the boiler inlet sensor to the Boil In terminal 24.
- Connect the second wire to the Com terminal 25.

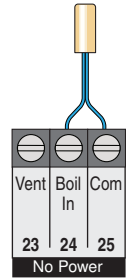

Wiring a Boiler Supply Sensor (tekmar 082)

Terminals 18, 19

A boiler supply sensor measures the temperature of water coming from the boiler plant. This sensor should be installed on the supply pipe ahead of the tees supplying any loads.

- Connect one wire from the boiler supply sensor to the Boil Sup terminal 18.
- Connect the second wire to the Com terminal 19.

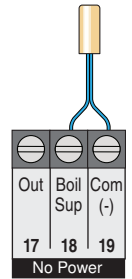

Wiring a Boiler Return Sensor (tekmar 082)

Terminals 20, 22

A boiler return sensor measures the temperature returning to the boiler plant. This sensor can be installed on the return side of the primary loop, ahead of the boiler plant piping.

- Connect one wire from the boiler return sensor to the Boil Ret terminal 20.
- Connect the second wire to the Com terminal 22.

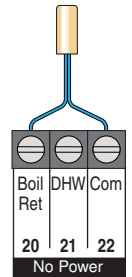

Wiring a DHW Sensor (tekmar 082)

Terminals 21 to 22

A DHW sensor is used to measure the temperature of a DHW tank. For indirect DHW heating, the DHW sensor can be used instead of a DHW aquastat. For direct DHW heating, only the DHW sensor can be used to control the temperature of the DHW tank.

- Connect one wire from the DHW sensor to the DHW terminal 21.
- Connect the second wire to the Com terminal 22.

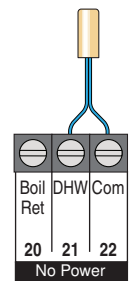

Wiring a Flow Sensor

Terminals 11, 12

An analog flow sensor can be connected to the 284 to provide flow monitoring. The control supports a 4-20 mA style sensor. Examples of compatible aftermarket flow sensors include the Kele SDI series, 2200 & 3100 series and 200 series (requires 310 transmitter). Using the boiler supply sensor & the boiler return sensor, energy output can be calculated & displayed from the flow measurement. The flow sensor can also be used to prove primary pump flow.

- Connect one wire from the flow sensor to the 20 V dc Out terminal 11.
- Connect the second wire to mA (+) In terminal 12.

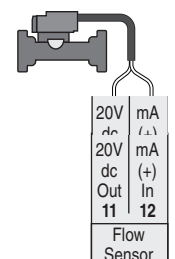

⚠ Wiring a Pressure Sensor

Terminals 13 to 15

An analog pressure sensor can be connected to the 284 to provide water pressure monitoring. The control supports a V (dc) style pressure sensor with a signal range of 0.5 to 4.5 V (dc). Examples of compatible aftermarket pressure sensors include the Honeywell PX2 (AA) series and the Measurement Specialties 7100 series.

- Connect one wire from the power supply (+5 VDC) on the pressure sensor to the 5V dc Out terminal 13.
- Connect one wire from the pressure signal on the pressure sensor to the Vdc (+) In terminal 14.
- Connect one wire from the GND (0V) on the pressure sensor to the Gnd (-) terminal 15.

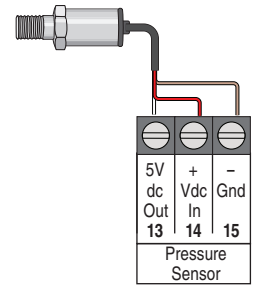

⚠ Wiring a Vent Sensor

Terminals 23, 25

A vent sensor can be connected to the 284 to provide monitoring of the common boiler plant exhaust vent temperature. Compatible sensors include a 10K ohm NTC curve J thermistor. The control is capable of displaying temperatures up to 500°F (260°C). The vent sensor can also be used to provide a vent temperature limiting feature.

- Connect one wire from the vent sensor to the Vent terminal 23.
- Connect the second wire to the Com terminal 25.

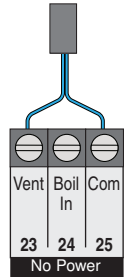

EMS, Modbus® & BACnet® Connections

⚠ EMS Connection

Terminals 16, 19

An Energy Management System (EMS) can be connected to the 284 to provide a target water temperature. Either a 0 to 10 V (dc) or 2 to 10 V (dc) signal may be used.

- Connect one wire from the EMS to the EMS (+) In terminal 16.
- Connect a second wire from the EMS to the Com (-) terminal 19.

A 0 - 20 mA signal can be converted to a 0 - 10 V (dc) signal by installing a 500 Ω resistor in parallel between the Com (-) & EMS (+) In terminals (19 & 16). The EMS Signal setting must be set to 0-10.

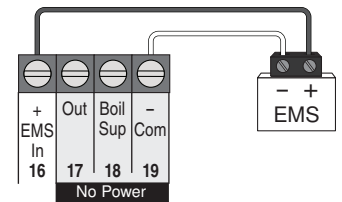

A 4 - 20 mA signal can be converted to a 2 - 10 V (dc) signal by installing a 500 Ω resistor in parallel between the Com (-) & EMS (+) In terminals (19 & 16). The EMS Signal setting must be set to 2-10.

The APP MODE setting in the Setup Menu must be set to EMS.

⚠ Modbus® Connection

Terminals 40 to 42

A Building Automation System (BAS) can be connected to the 284 for remote monitoring & adjustment capability. Modbus® communications use an RS 485 connection. Use 18 AWG Twisted Shielded Pair cable. Cable length is dependent on the baud rate & whether or not terminating resistors are used. Refer to the BAS Integration Manual 284_B for details on the maximum recommended cable length.

- Connect the B (+) terminal on the BAS network to the RS 485 B (+) terminal 40.
- Connect the A (-) terminal on the BAS network to the RS 485 A (-) terminal 41.
- Connect the ground (G) terminal on the BAS network to the Gnd terminal 42.

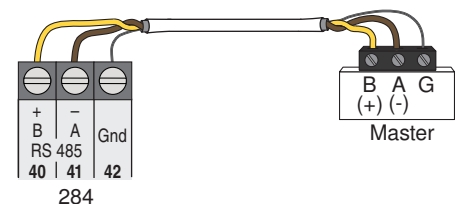

BACnet® Connection

RJ45 Plug

A Building Automation System (BAS) can be connected to the 284 for remote monitoring & adjustment capability. BACnet® IP communications use an ethernet socket. Use a CAT-5E or CAT-6 cable. The maximum recommended cable length for CAT-5E is 150 ft. (45.7 m) & 300 ft. (91.4 m) for CAT-6.

- Connect the Ethernet RJ45 socket on the BACnet® IP network to the Ethernet RJ45 socket on the 284.

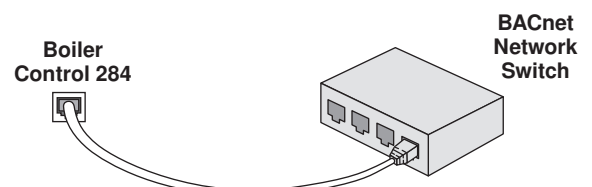

Wiring the tekmarNet® Devices

tN4 Boiler Bus b

Terminals 32 - 33

Terminals 32 & 33 provide communication for tN4 devices on the tN4 Boiler Bus b. Connect terminals 32 (tN4) & 33 (C0) to the corresponding terminals on the tN4 devices that are to be connected.

The connection is polarity sensitive. Ensure that terminal 32 (tN4) is connected to the tN4 terminal on the tN4 device & that terminal 33 (C0) is connected to the C terminal on the tN4 device.

tN4 Boiler Bus 1

Terminals 34 - 35

Terminals 34 & 35 provide communication for tN4 devices on the tN4 Boiler Bus 1. Connect terminals 34 (tN4) & 35 (C1) to the corresponding terminals on the tN4 devices that are to be connected.

The connection is polarity sensitive. Ensure that terminal 34 (tN4) is connected to the tN4 terminal on the tN4 device & that terminal 35 (C1) is connected to the C terminal on the tN4 device.

tN4 Boiler Bus 2

Terminals 36 - 37

Terminals 36 & 37 provide communication for tN4 devices on the tN4 Boiler Bus 2. Connect terminals 36 (tN4) & 37 (C2) to the corresponding terminals on the tN4 devices that are to be connected.

The connection is polarity sensitive. Ensure that terminal 36 (tN4) is connected to the tN4 terminal on the tN4 device & that terminal 37 (C2) is connected to the C terminal on the tN4 device.

tN4 Boiler Bus 3

Terminals 38 - 39

Terminals 38 & 39 provide communication for tN4 devices on the tN4 Boiler Bus 3. Connect terminals 38 (tN4) & 39 (C3) to the corresponding terminals on the tN4 devices that are to be connected.

The connection is polarity sensitive. Ensure that terminal 38 (tN4) is connected to the tN4 terminal on the tN4 device & that terminal 39 (C3) is connected to the C terminal on the tN4 device.

Testing the Sensor Wiring

A good quality test meter capable of measuring up to 5,000 k Ω (1 k Ω = 1000 Ω) is required to measure the sensor resistance. In addition to this, the actual temperature must be measured with either a good quality digital thermometer, or if a thermometer is not available, a second sensor can be placed alongside the one to be tested & the readings compared.

First measure the temperature using the thermometer & then measure the resistance of the sensor at the control. The wires from the sensor must not be connected to the control while the test is performed. Using the chart below, estimate the temperature

measured by the sensor. The sensor & thermometer readings should be close. If the test meter reads a very high resistance, there may be a broken wire, a poor wiring connection or a defective sensor. If the resistance is very low, the wiring may be shorted, there may be moisture in the sensor or the sensor may be defective. To test for a defective sensor, measure the resistance directly at the sensor location.

Do not apply voltage to a sensor at any time as damage to the sensor may result.

Temperature		Resistance	Temperature		Resistance	Temperature		Resistance	Temperature		Resistance
°F	°C	Ω	°F	°C	Ω	°F	°C	Ω	°F	°C	Ω
-50	-46	490,813	20	-7	46,218	90	32	7,334	160	71	1,689
-45	-43	405,710	25	-4	39,913	95	35	6,532	165	74	1,538
-40	-40	336,606	30	-1	34,558	100	38	5,828	170	77	1,403
-35	-37	280,279	35	2	29,996	105	41	5,210	175	79	1,281
-30	-34	234,196	40	4	26,099	110	43	4,665	180	82	1,172
-25	-32	196,358	45	7	22,763	115	46	4,184	185	85	1,073
-20	-29	165,180	50	10	19,900	120	49	3,760	190	88	983
-15	-26	139,403	55	13	17,436	125	52	3,383	195	91	903
-10	-23	118,018	60	16	15,311	130	54	3,050	200	93	829
-5	-21	100,221	65	18	13,474	135	57	2,754	205	96	763
0	-18	85,362	70	21	11,883	140	60	2,490	210	99	703
5	-15	72,918	75	24	10,501	145	63	2,255	215	102	648
10	-12	62,465	80	27	9,299	150	66	2,045	220	104	598
15	-9	53,658	85	29	8,250	155	68	1,857	225	107	553

Testing the Power

If the control display does not turn on, check the Power In L & N terminals (83 & 84) using an electrical multimeter. The voltage should measure between 103.5 to 126.5 V (ac).

User Test (HAND)

Manual Override Button

The User Test (HAND mode) is one of the Manual Override modes of the control. Refer to the Hand mode for a description of the steps that are included to operate the outputs. The steps are dependent how the boiler(s) (Source # Menu) & the system (Setup menu) are configured.



Testing the Auxiliary Relay

Activate the HAND mode within the Manual Override. Select the Auxiliary item & set it to ON. Using an electrical meter, measure for continuity between the Auxiliary terminals (43 & 44).

Testing the Alert Relay

Activate the HAND mode within the Manual Override. Select the Alert item & set it to ON. Using an electrical meter, measure for continuity between the Alert terminals (45 & 46).

Testing the Primary Pumps

Activate the HAND mode within the Manual Override.

For primary pump 1, select the Primary Pump item & set it to PMP1. Using an electrical meter, measure for continuity between the Primary Pump 1 terminals (47 & 48).

For primary pump 2, select the Primary Pump item & set it to PMP2. Using an electrical meter, measure for continuity between the Primary Pump 2 terminals (49 & 50).

Testing the Indirect DHW Pump

Activate the HAND mode within the Manual Override. Select the DHW Pump item & set it to ON. Using an electrical meter, measure for continuity between the IDHW Pump terminals (85 & 86).

Testing the Boiler Pump(s) / Isolation Valve(s)

Activate the HAND mode within the Manual Override.

For a boiler pump, select the Boil 1 PUMP item & set it to ON. Using an electrical meter, measure for continuity between the Boiler 1 Pump / Valve terminals (75 & 76).

For an isolation valve, select the Boil 1 VALVE item & set it to ON. Using an electrical meter, measure for an open circuit between the Boiler 1 Pump / Valve terminals (75 & 76).

Repeat the steps above for Boiler Pumps 2, 3 & 4.

Testing the Boiler Stage(s)

This test applies for single stage & two stage boilers only. Activate the HAND mode within the Manual Override. For a single stage boiler, select the Boil STG item & set it to 1. Using an electrical meter, measure for continuity between the Boiler 1 Stage 1 terminals (53 & 54).

For a two stage boiler, select the Boil STG item & set it to 1. Using an electrical meter, measure for continuity between the Boiler 1 Stage 1 terminals (53 & 54). Set the Boil STG item to 2. Using an electrical meter, measure for continuity between the Boiler 1 Stage 2 terminal (55 & 56).

Repeat the steps above, as applicable, for Boilers 2, 3 & 4.

Testing the Modulating Boiler Output

This test applies for modulating boilers only.

Activate the HAND mode within the Manual Override.

Select the Boil 1 MOD item & set a desired firing rate. Using an electrical meter, measure for either a V (dc) or mA signal between the Boiler + Mod - terminals (51 & 52). The reading should be between 0 V (dc) & 10 V (dc) or 4 mA & 20 mA.

Repeat the steps above for Boilers 2, 3 & 4.

Testing the Temperature Boiler Output

This test applies for EMS boilers only. Activate the HAND mode within the Manual Override.

Select the Boil 1 TEMP item & set a desired temperature between the EMS TEMP MIN and EMS TEMP MAX values. Using an electrical meter, measure for either a V (dc) or mA signal between the Boiler + Mod - terminals (51 & 52). The reading should be between 0 V (dc) & 10 V (dc) or 4 mA & 20 mA.

Repeat the steps above, as applicable, for Boilers 2, 3 & 4.

Testing the Heat Call

Terminals 5 & 6

Set the Application Mode to RSET. Remove all wires from the Heat Call terminals (5 & 6). The control display should show no Heat Call. Reconnect wires. Then apply either a

short circuit or 24 V (ac) over the Heat Call terminals. The control should now show a Heat Call.

Testing the DHW Call

Terminals 7 & 8

Set the Application Mode to either RSET, SETP or EMS. Remove all wires from the DHW Call terminals (7 & 8). The control display should show no DHW Call. Reconnect wires.

Then apply either a short circuit or 24 V (ac) over the DHW Call terminals. The control should now show a DHW Call.

Testing the Setpoint Call

Terminals 9 & 10

Set the Application Mode to either RSET, SETP or EMS. Remove all wires from the Setpoint Call terminals (9 & 10). The control display should show no Setpoint Call. Reconnect

wires. Then apply either a short circuit or 24 V (ac) over the Setpoint Call terminals. The control should now show a Setpoint Call.

Control Settings

Access Level

The access level restricts the number of menus & items that can be accessed by the user. The Access Level setting is found in the Toolbox menu. Select the appropriate access level for the people who work with the control on a regular basis. There are three Access Level settings:





- User (USER): Select this access level to limit the number of items available to the end user.
- Installer (INST): Select this access level to limit some of the

items available to the installer. This is the factory default access level. The 284 defaults to the 'Installer' access level after 24 hours.

- Advanced (ADV): Select this access level to have complete access to all of the items.

The Lock / Unlock switch on the front of the control must be set the Unlock position to change the access level.

DIP Switch Settings

DIP	Description	Default
	<p>Lock / Unlock & Access Levels</p> <p>Use this DIP switch to lock & unlock the Access Level of the 284 & all connected tN4 devices, including tN4 thermostats. For details, see above.</p> <ul style="list-style-type: none"> • Once unlocked, the access level can be changed in the Toolbox menu. • Once locked, the access level in all devices cannot be viewed or changed. • When the control is locked a small segment representing a padlock is show in the display. 	Unlocked
 External Flow Proof / Off	<p>External Flow Proof / Off</p> <p>Use this DIP switch to select whether or not the Flow Proof Feature is to be used.</p> <ul style="list-style-type: none"> • If the Flow Proof feature is being used, set the DIP switch to the External Flow Proof position. The control must receive an external Flow Proof Call within a period of time once a primary pump is turned on. • If the Flow Proof feature is not being used, set the DIP switch to the Off position. • The flow proof call feature can only be used when the control is configured to operate the primary pump for all loads. If there are multiple loads (e.g. Heat Call and DHW Call) and the primary pump is disabled for DHW operation, then the control cannot provide flow proving and the feature must be disabled. In this case, the flow proof feature must be obtained through another control such as the Pump Sequencer 132. 	Off
 External C.A. Proof / Off	<p>External C.A. Proof / Off</p> <p>Use this DIP switch to select whether or not the C.A. Proof Feature is to be used.</p> <ul style="list-style-type: none"> • If the C.A. Proof feature is being used, set the DIP switch to the External C.A. Proof position. The control must receive an external C.A Proof Call within a period of time once the C.A. damper is turned on. • If the C.A. Proof feature is not being used, set the DIP switch to the Off position. 	Off
 Off / Exercise	<p>Off / Exercise</p> <p>Use this DIP switch to select whether or not the control is to exercise all pumps for 10 seconds every three days of inactivity.</p>	Exercise
 Setback / Off	<p>Setback / Off</p> <p>Use this DIP switch to select whether or not the control is to follow a schedule.</p>	Off

User Interface

Display

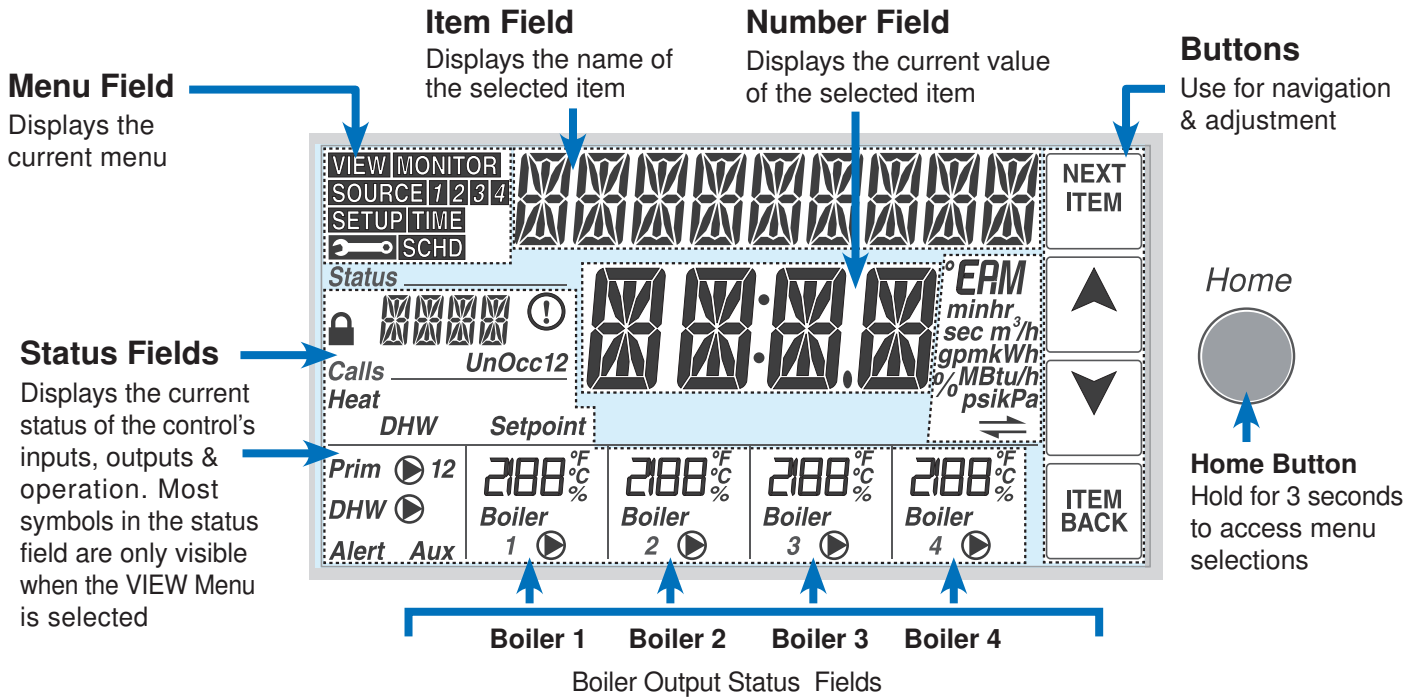

Symbols

Heat, DHW, Setpoint	CALLS Displays any call the control is receiving.	$^{\circ}\text{F}, ^{\circ}\text{C}, \text{AM}, \text{PM}, \text{min}, \text{hr}, \text{m}^3/\text{h}, \text{gpm}, \text{kWh}, \%, \text{MBtu}, \text{psi}, \text{kPa}$	$^{\circ}\text{F}, ^{\circ}\text{C}, \text{AM}, \text{PM} \dots$ Units of measurement for current number.
Prim	PRIMARY PUMP Displays when primary pump 1 or primary pump 2 is operating.		WARNING Displays if an error or warning exists on the system.
DHW	DHW PUMP Displays when the DHW pump is operating.	1	BOILER PUMP / VALVE Displays when a boiler 1 pump / valve is operating.
Alert	ALERT Displays if an error or warning exists.	Boiler 1	BOILER Indicates that the boiler 1 is operating (flashing icon indicates boiler is igniting).
Aux	AUXILIARY Displays when the C.A. damper or DHW recirculation pump is operating.	2188 $^{\circ}\text{F}$ $^{\circ}\text{C}$ $\%$	BOILER OUTPUT Displays output of boiler 1. Dependent on boiler type. "--" is displayed when the boiler is off. <ul style="list-style-type: none"> • <u>Single stage</u>: 100% (On) • <u>Two stage</u>: 50% (stage 1 On), 100% (stage 2 On) • <u>Modulating</u>: current modulation % • <u>EMS</u> = current setpoint temperature
	tekmarNet[®] The 284 is communicating with other tekmarNet [®] devices.		

Navigating The Display

The menu items of the 284 are described in detail in the following pages. The number of available items changes depending on the control configuration. To find out what other settings affect the display of an item, refer to the menu descriptions.

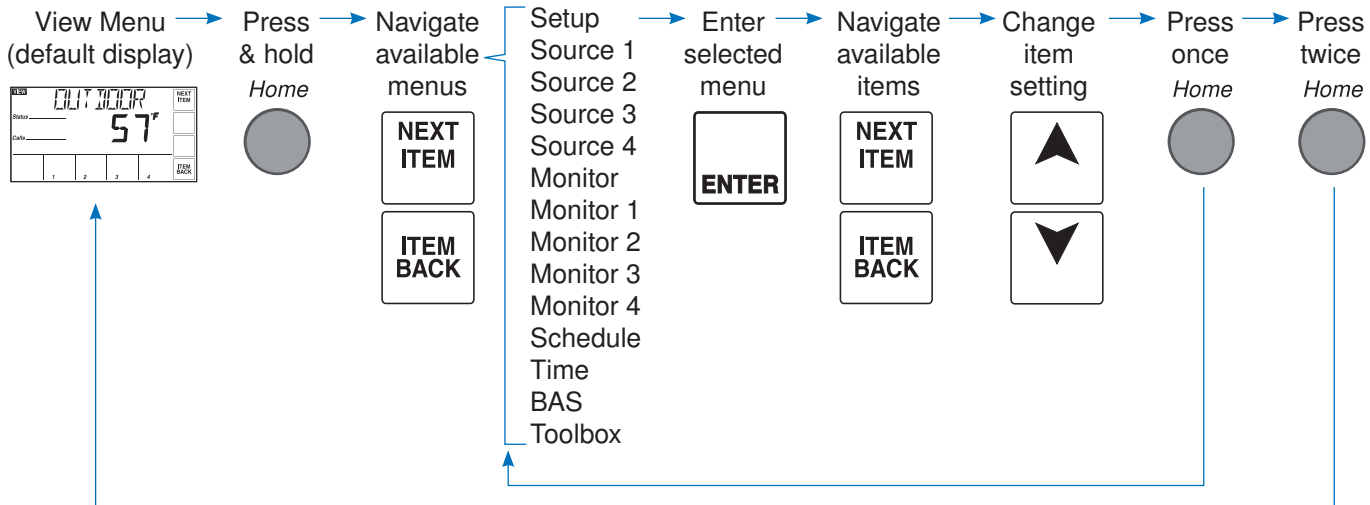





View Menu (1 of 2)

The View Menu includes general information about boiler & pump operation, calls & temperatures. The View Menu is the default display of the 284.

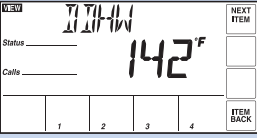
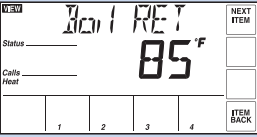
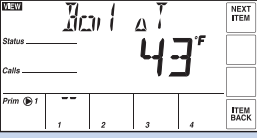
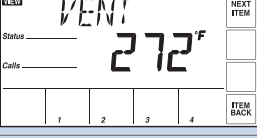
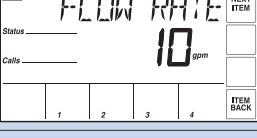

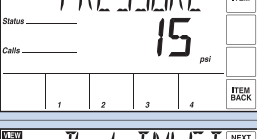
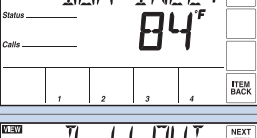
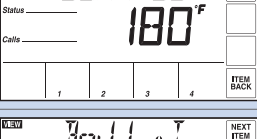
Item Field	Range	Description
	<p>Access: User</p>	<p>TIME Current date & time. This item is only available when the Setback / Off switch is set to Setback & Clock (Time menu) is set to ON.</p>
	<p>---, -76 to 149°F (-60.0 to 65.0°C) Access: User</p>	<p>OUTDOOR Current outdoor temperature as measured by the outdoor sensor. "----" is displayed if there is a sensor fault. This item is only available when Application Mode is set to RSET or an outdoor sensor is connected.</p>
	<p>---, -22 to 266°F (-30 to 130°C) Access: User</p>	<p>BOILER SUPPLY Current boiler supply water temperature as measured by the boiler supply sensor. "----" is displayed if there is a sensor fault.</p>
	<p>---, -22 to 266°F (-30 to 130°C) Access: ADV</p>	<p>BOILER TARGET The boiler target is the temperature the control is trying to maintain at the boiler supply sensor. "----" is displayed when no heat is required.</p>
	<p>---, -22 to 266°F (-30.0 to 130.0°C) Access: ADV</p>	<p>INDIRECT DHW EXCHANGE TEMPERATURE The indirect DHW exchange target is the temperature the control is trying to maintain at the boiler 4 outlet sensor. "----" is displayed when no heat is required. This item is only available if Application Mode is set to RSET, SETP or EMS, IDHW Mode is set to ON & IDHW Location is set to NEAR.</p>
	<p>---, -22 to 266°F (-30.0 to 130.0°C) Access: User</p>	<p>INDIRECT DHW Current indirect DHW tank temperature as measured by the DHW sensor. "----" is displayed if there is a sensor fault. This item is only available if Application Mode is set to RSET, SETP or EMS, IDHW Mode is set to ON & IDHW Sensor is set to ON.</p>

View Menu (2 of 2)

Item Field	Range	Description
	---, -22 to 266 °F (-30.0 to 130.0 °C) <i>Access: User</i>	DEDICATED DHW Current dedicated DHW tank temperature as measured by the DHW sensor. "----" is displayed if there is a sensor fault. This item is only available if Application Mode is set to DDHW.
	---, -22 to 266 °F (-30.0 to 130.0 °C) <i>Access: ADV</i>	BOILER RETURN Current boiler return water temperature as measured by the boiler return sensor. "----" is displayed if there is a sensor fault. This item is only available if a boiler return sensor is connected.
	-22 to 266 °F (-12.0 to 148.0 °C) <i>Access: ADV</i>	BOILER SUPPLY DIFFERENTIAL Current temperature difference between the boiler supply & boiler return sensors. This item is only available if boiler supply & boiler return sensors are connected.
	---, -40 to 500 °F (-40.0 to 260.0 °C) <i>Access: ADV</i>	VENT TEMPERATURE Current vent temperature of the boiler plant. "----" is displayed if there is a sensor fault. This item is only available if a vent sensor is connected.
	GPM or m ³ /h <i>Access: ADV</i>	FLOW RATE Current flow rate as measured by the flow sensor. This item is only available if Flow Sensor is set to ON.
	MBtu/h or kW <i>Access: ADV</i>	BOILER LOAD Current boiler plant output. This item is only available if Flow Sensor is set to ON & if boiler supply & boiler return sensors are connected.
	psi or kPa <i>Access: ADV</i>	PRESSURE Current system pressure as measured by the pressure sensor. This item is only available if Pressure Sensor is set to ON.
	---, -22 to 266 °F (-30.0 to 130.0 °C) <i>Access: ADV</i>	BOILER INLET TEMPERATURE Current boiler inlet water temperature. This item is only available if a boiler inlet sensor is connected.
	---, -22 to 266 °F (-30.0 to 130.0 °C) <i>Access: ADV</i>	BOILER (#) OUTLET SENSOR Current boiler outlet temperature of boiler 1. This item is available for all enabled boilers provided their respective boiler outlet sensor is connected.
	-22 to 266 °F (-12.0 to 148.0 °C) <i>Access: ADV</i>	BOILER (#) TEMPERATURE DIFFERENTIAL Current temperature difference between the boiler 1 outlet & boiler inlet sensors. This item is available for all enabled boilers provided their respective boiler outlet sensor & the common boiler inlet sensor are connected.

Setup Menu (1 of 6)

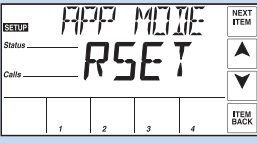
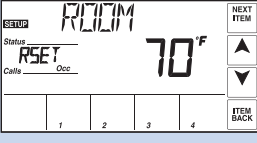
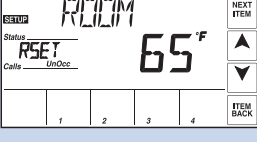
Setup Menu items are used for system specific configuration.

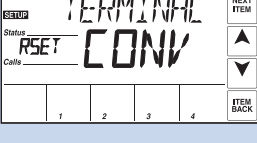
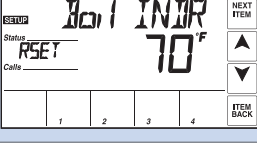
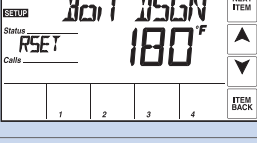
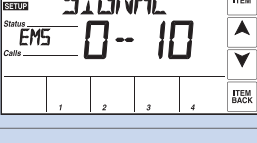
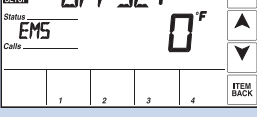
Item Field	Range	Description
	RSET, SETP, DDHW, EMS, BAS Default = RSET Access: INST	APPLICATION MODE RSET = Outdoor Temperature Reset SETP = Setpoint Heating DDHW = Dedicated DHW Heating EMS = Energy Management System BAS = Building Automation System
	35 to 100°F (2.0 to 38.0°C) Default = 70°F (21.0°C) Access: INST	ROOM OCCUPIED The desired room air temperature during the occupied periods. This item is only available if the Application Mode is set to RSET.
	35 to 100°F (2.0 to 38.0°C) Default = 65°F (18.5°C) Access: INST	ROOM UNOCCUPIED The desired room air temperature during the unoccupied periods. This item is only available if the Application Mode is set to RSET, Setback / Off switch is set to Setback & a schedule is selected.
	OFF, 0:20 to 8:00 hrs Default: OFF Access: ADV	BOOST The maximum amount of morning boost when change from the unoccupied to the occupied period. This item is only available if the Application Mode is set to RSET & the Setback / Off switch is set to Setback.
	-60 to 45°F (-51.0 to 7.0°C) Default: 10°F (-12.0°C) Access: INST	OUTDOOR DESIGN The design outdoor air temperature used in the heat loss calculations for the space heating system. Typically set to the outdoor temperature of the coldest day of the year. This item is only available if the Application Mode is set to RSET.
	HRF1, HRF2, COIL, CONV, RAD, BASE Default: CONV Access: INST	TERMINAL UNIT The type of terminal units that are being used for the space heating system. Selection includes: high mass radiant floor (HRF1), low mass radiant floor (HRF2), fancoil (COIL), fin-tube baseboard (CONV), radiator (RAD) & cast iron baseboard (BASE). This item is only available if the Application Mode is set to RSET.
	35 to 100°F (2.0 to 38.0°C) Default: 70°F (21.0°C) Access: ADV	BOILER INDOOR The design indoor air temperature used in the heat loss calculations for the space heating system. This item is only available if the Application Mode is set to RSET.
	70 to 230°F (21.0 to 110.0°C) Default: 180°F (82.0°C) Access: ADV	BOILER DESIGN The supply water temperature required for the space heating system on the typical coldest day of the year. This item is only available if the Application Mode is set to RSET.
	0-10 or 2-10 Default: 0-10 Access: ADV	EMS SIGNAL Selects the analog input signal range used with the Energy Management System (EMS). This item is only available if the Application Mode is set to EMS.
	-10 to 10°F (-5.5 to -5.5°C) Default: 0°F (0.0°C) Access: ADV	EMS OFFSET Selects the offset from the boiler target temperature interpreted from the EMS analog input signal. This item is only available if the Application Mode is set to EMS.



Setup Menu (2 of 6)

Item Field	Range	Description
	OFF, 60 to 180°F (OFF, 15.5 to 82.0°C) Default: 140°F (60.0°C) Access: ADV	BOILER MINIMUM The minimum allowed boiler target temperature used for the non-condensing boiler group. Check the boiler manufacturer's manual for recommended minimum boiler supply temperatures. This item is only available if there is at least one boiler set to auto (Boiler Enable = AUTO) & non-condensing (Boiler Condense = NO).
	90 to 225°F, OFF (32.0 to 107.0°C, OFF) Default: 200°F (93.0°C) Access: ADV	BOILER MAXIMUM The maximum allowed boiler target temperature.
	PUMP or VALV Default: PUMP Access: ADV	PLANT FLOW Selects whether each boiler is to use a pump or valve.
	AUTO, 2 to 42°F AUTO, 1.0 to 23.5°C Default: AUTO Access: ADV	BOILER DIFFERENTIAL The temperature differential that the control is to use to cycle the boiler On & Off (half above & half below the boiler target temperature). This item is only available if Application Mode is set to either RSET, SETP, EMS or BAS.
	OFF, DMPR, DHWR Default: OFF Access: ADV	AUXILIARY RELAY Selects the operation of the auxiliary relay to be either Combustion Air Damper (DMPR) or DHW Recirculation Pump (DHWR). If the External C.A. Proof / Off switch is set to External C.A. Proof, this setting is fixed at DMPR.
	OFF or AUTO Default: AUTO Access: ADV	PRIMARY PUMP 1 Selects whether primary pump 1 is operational or not. This item is only available if Application Mode is set to either RSET, SETP, EMS or BAS.
	OFF or AUTO Default: OFF Access: ADV	PRIMARY PUMP 2 Selects whether primary pump 2 is operational or not. This item is only available if Application Mode is set to either RSET, SETP, EMS or BAS.
	12 to 180 hr, OFF Default: 96 hr Access: ADV	ROTATE PRIMARY PUMPS Sets the frequency of rotation of the primary pumps. This item is only available if Application Mode is set to either RSET, SETP, EMS or BAS & Primary Pump 1 & Primary Pump 2 is set to AUTO.
	OFF, 0:10 to 20:00 min Default: 0:20 min Access: ADV	PRIMARY PUMP PURGE Time the primary pump remains on once the appropriate calls (heat, setpoint or DHW) are removed to purge heat from the boiler plant. This item is only available if Application Mode is set to either RSET, SETP, EMS or BAS & Primary Pump 1 or Primary Pump 2 is set to AUTO.
	0:10 to 3:00 min Default: 0:30 min Access: ADV	FLOW PROOF DELAY The time allowed for the control to receive a flow proof call once the primary pump turns on. This item is only available if the External Flow Proof / Off switch is set to External Flow Proof.
	0:10 to 3:00 min Default: 1:00 min Access: ADV	CA PROOF DELAY The time allowed for the control to receive a C.A. proof call once the C.A. damper (Aux) relay turns on. This item is only available if the External C.A. Proof / Off switch is set to External C.A. Proof.

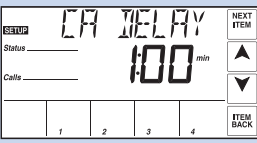
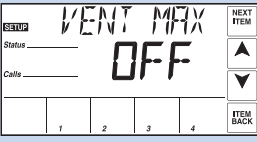
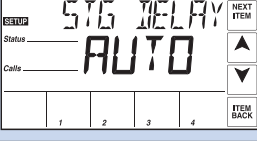
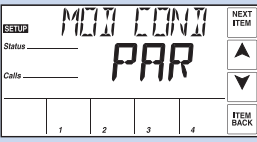
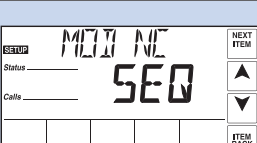
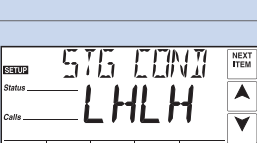
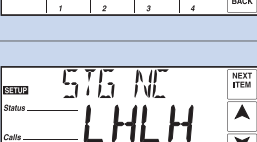
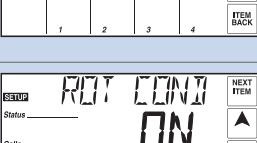
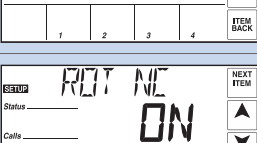
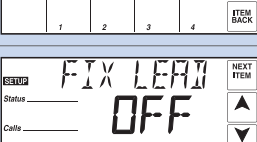
Setup Menu (3 of 6)

Item Field	Range	Description
	OFF, 0:10 to 3:00 min Default: 1:00 min <hr/> Access: ADV	CA DELAY The time delay for the first boiler to operate once the C.A. damper (Aux) relay turns on. This item is only available if the External C.A. Proof / Off switch is set to Off & Auxiliary Relay is set to DMPR.
	150 to 350°F, OFF (65.5 to 177.0°C) Default: OFF <hr/> Access: ADV	VENT MAXIMUM The maximum vent temperature that is used for vent temperature limiting. The boiler plant will be shut down if the vent temperature rises to the vent maximum temperature. Set to OFF if only vent temperature monitoring is desired.
	AUTO, 0:30 to 40:00 min Default: AUTO <hr/> Access: ADV	STAGE DELAY The minimum time delay between the operation of boiler stages, either within a boiler or between boilers. This item is only available if there are at least two boilers set to auto (Boiler Enable = AUTO).
	SEQ or PAR Default: PAR <hr/> Access: ADV	MODULATION MODE CONDENSING Selects either sequential or parallel modulation for multiple modulating condensing boilers. This item is only available if there are at least two boilers set to auto (ENABLE=AUTO), condensing (Boiler Condense = YES) & Modulating (Boiler Type = MOD or EMS).
	SEQ, PAR Default: SEQ <hr/> Access: ADV	MODULATION MODE NON-CONDENSING Selects either sequential or parallel modulation for multiple modulating non-condensing boilers. This item is only available if there are at least two boilers set to auto (Boiler Enable = AUTO), non-condensing (Boiler Condense = NO) & Modulating (Boiler Type = MOD or EMS).
	LHLH or LLHH Default: LHLH <hr/> Access: ADV	STAGING MODE CONDENSING Selects either low-high-low-high (LHLH) or low-low-high-high (LLHH) staging for multiple two-stage condensing boilers. This item is only available if there are at least two boilers set to auto (Boiler Enable = AUTO), condensing (Boiler Condense = YES) & two stage (Boiler Type = 2STG).
	LHLH or LLHH Default: LHLH <hr/> Access: ADV	STAGING MODE NON-CONDENSING Selects either low-high-low-high (LHLH) or low-low-high-high (LLHH) staging for multiple two-stage non-condensing boilers. This item is only available if there are at least two boilers set to auto (Boiler Enable = AUTO), non-condensing (Boiler Condense=NO) & two stage (Boiler Type = 2STG).
	OFF or ON Default: ON <hr/> Access: ADV	ROTATION CONDENSING BOILER GROUP Selects the equal run time rotation feature within the condensing boiler group. This item is only available if there are at least two boilers set to auto (Boiler Enable = AUTO) & condensing (Boiler Condense = YES).
	OFF or ON Default: ON <hr/> Access: ADV	ROTATION NON-CONDENSING BOILER GROUP Selects the equal run time rotation feature within the non-condensing boiler group. This item is only available if there are at least two boilers set to auto (Boiler Enable = AUTO) & non-condensing (Boiler Condense = NO).
	OFF or ON Default: OFF <hr/> Access: ADV	FIXED LEAD Selects whether or not the first boiler is to be excluded from the rotation sequence. If set to ON, boiler 1 is always the first to fire. This item is only available if boiler 1 is enabled (Boiler Enable = AUTO) & all available boilers are either condensing or non-condensing.

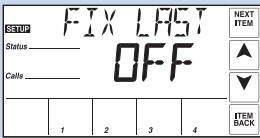
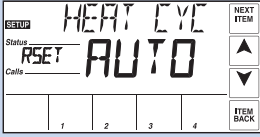
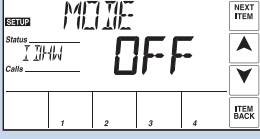
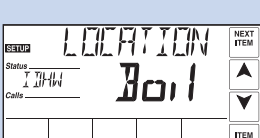
Setup Menu (4 of 6)

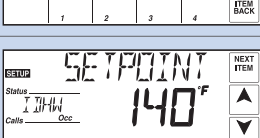
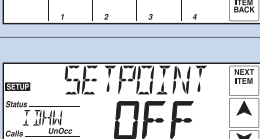
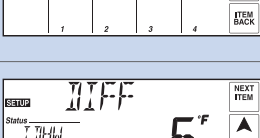
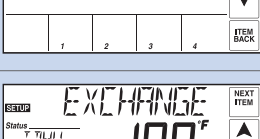
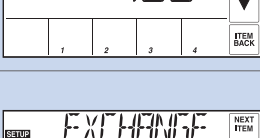
Item Field	Range	Description
	OFF or ON Default: OFF <hr/> Access: ADV	FIXED LAST Selects whether or not the last boiler is to be excluded from the rotation sequence. If set to ON, boiler 4 is always the last to fire. This item is only available if boiler 4 is enabled (Boiler Enable = AUTO) & all available boilers are either condensing or non-condensing.
	AUTO, 5 to 30 min Default: AUTO <hr/> Access: ADV	HEATING CYCLES The cycle length to which all tN4 devices will synchronize. This item is only available when Application Mode is set to RSET & a tN4 device is present.
	OFF or ON Default: OFF <hr/> Access: ADV	INDIRECT DHW MODE Selects whether indirect DHW heating is active or not. This item is only available when Application Mode is set to RSET, SETP or EMS.
	NEAR or Boil Default: Boil <hr/> Access: ADV	INDIRECT DHW LOCATION Selects the location of the indirect DHW tank. NEAR = Near boiler piping supplied by boiler 4. Boil = Boiler system piping supplied by boiler plant. This item is only available when Application Mode is set to RSET, SETP or EMS & Indirect DHW Mode is set to ON. NEAR is only available when Plant Flow is set to PUMP.
	OFF or ON Default: OFF <hr/> Access: ADV	INDIRECT DHW SENSOR Selects if a DHW Sensor is to be used for indirect DHW heating. This item is only available when Application Mode is set to RSET, SETP or EMS & Indirect DHW Mode is set to ON.
	70 to 190°F (21.0 to 88.0°C) Default: 140°F (60.0°C) <hr/> Access: ADV	INDIRECT DHW SETPOINT OCCUPIED The temperature of the indirect DHW tank during the occupied periods. This item is only available when Application Mode is set to RSET, SETP or EMS, Indirect DHW Mode is set to ON & Indirect DHW Sensor is set to ON.
	OFF, 70 to 190°F (21.0 to 88.0°C) Default: OFF <hr/> Access: ADV	INDIRECT DHW SETPOINT UNOCCUPIED The temperature of the indirect DHW tank during the unoccupied periods. If operation is not desired during the unoccupied periods, select OFF. This item is only available when Application Mode is set to RSET, SETP or EMS, Indirect DHW Mode is set to ON, Indirect DHW Sensor is set to ON & the Setback / Off switch is set to Setback.
	1 to 42°F (0.5 to 23.5°C) Default: 6°F (3.0°C) <hr/> Access: ADV	INDIRECT DHW DIFFERENTIAL The temperature differential of the indirect DHW tank from the IDHW SETPOINT settings. This item is only available when Application Mode is set to RSET, SETP or EMS, Indirect DHW Mode is set to ON & Indirect DHW Sensor is set to ON.
	100 to 220°F (38.0 to 104.0°C) Default: 180°F (82.0°C) <hr/> Access: ADV	INDIRECT DHW EXCHANGE OCCUPIED The boiler target temperature for the indirect DHW heat exchanger during the occupied periods. This item is only available when Application Mode is set to RSET, SETP or EMS, Indirect DHW Mode is set to ON & Indirect DHW Sensor is set to OFF.
	OFF, 100 to 220°F (OFF, 38.0 to 104.0°C) Default: OFF <hr/> Access: ADV	INDIRECT DHW EXCHANGE UNOCCUPIED The boiler target temperature for the indirect DHW heat exchanger during the unoccupied periods. If operation is not desired during the unoccupied periods, select OFF. This item is only available when Application Mode is set to RSET, SETP or EMS, Indirect DHW Mode is set to ON, Indirect DHW Sensor is set to OFF & the Setback / Off switch is set to Setback.

Setup Menu (5 of 6)





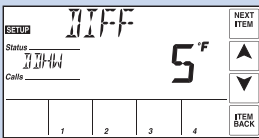
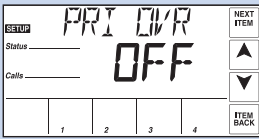
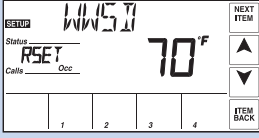
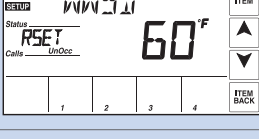
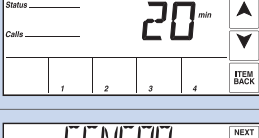
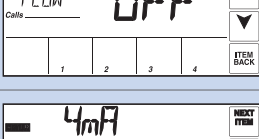
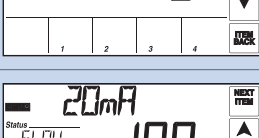
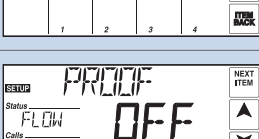
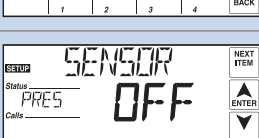
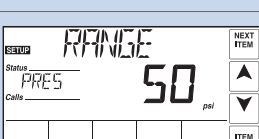
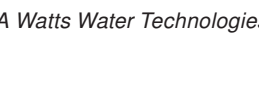

Item Field	Range	Description
	OFF or ON Default: OFF <hr/> Access: ADV	INDIRECT DHW PRIORITY Selects whether indirect DHW priority is active or not. This item is only available when Application Mode is set to RSET or EMS & Indirect DHW Mode is set to ON.
	1 to 4 Default: 2 <hr/> Access: ADV	INDIRECT DHW BOILER COUNT Selects the number of boilers to be used when only a DHW Call is present. This item is only available when Application Mode is set to RSET, SETP or EMS, Indirect DHW Mode is set to ON & Indirect DHW Location is set to Boil.
	OFF or ON Default: OFF <hr/> Access: ADV	PRIMARY PUMP DURING IDHW OPERATION Selects whether or not the primary pump is required to operate when a DHW Call is present. This item is only available when APP MODE is set to RSET, SETP or EMS, Primary Pump 1 or Primary Pump 2 is set to AUTO, Indirect DHW Mode is set to ON & Indirect DHW Location is set to Boil.
	OFF or ON Default: OFF <hr/> Access: ADV	SETPOINT MODE Selects whether setpoint operation is active or not. This item is only available when Application Mode is set to RSET, SETP or EMS.
	OFF or ON Default: OFF <hr/> Access: ADV	SETPOINT PRIORITY Selects whether setpoint priority is active or not. This item is only available when Application Mode is set to RSET or EMS & Setpoint Mode is set to ON.
	OFF or ON Default: OFF <hr/> Access: ADV	PRIMARY PUMP DURING SETPOINT OPERATION Selects whether or not the primary pump is required to operate when a Setpoint Call is present. This item is only available when Application Mode is set to RSET, SETP or EMS, Primary Pump 1 or Primary Pump 2 is set to AUTO & Setpoint Mode is set to ON.
	60 to 220°F (15.5 to 104.0°C) Default: 180°F (82.0°C) <hr/> Access: ADV	SETPOINT OCCUPIED TEMPERATURE The boiler target temperature when a Setpoint Call is present during the occupied periods. This item is only available when Application Mode is set to RSET, SETP or EMS & Setpoint Mode is set to ON.
	OFF, 60 to 220°F (15.5 to 104.0°C) Default: OFF <hr/> Access: ADV	SETPOINT UNOCCUPIED TEMPERATURE The boiler target temperature when a Setpoint Call is present during the unoccupied periods. If operation is not desired during the unoccupied periods, select OFF. This item is only available when Application Mode is set to RSET, SETP or EMS, Setpoint Mode is set to ON & the Setback / Off switch is set to Setback
	70 to 190°F (21.0 to 88.0°C) Default: 140°F (60.0°C) <hr/> Access: ADV	DEDICATED DHW OCCUPIED SETPOINT The temperature of the dedicated DHW tank during the occupied periods. This item is only available when Application Mode is set to DDHW.
	OFF, 70 to 190°F (21.0 to 88.0°C) Default: OFF <hr/> Access: ADV	DEDICATED DHW UNOCCUPIED SETPOINT The temperature of the dedicated DHW tank during the unoccupied periods. This item is only available when Application Mode is set to DDHW & the Setback / Off switch is set to Setback.

Setup Menu (6 of 6)

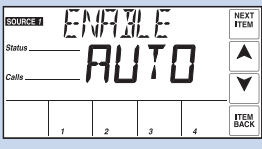

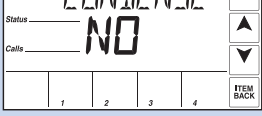
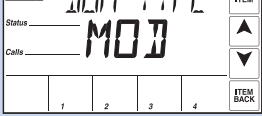
Item Field	Range	Description
	2 to 10°F (1.0 to 5.5°C) Default: 5°F (3.0°C)	DEDICATED DHW DIFFERENTIAL The temperature differential of the dedicated DHW tank from the DDHW SETPOINT settings. This item is only available when Application Mode is set to DDHW.
	OFF, AUTO, 0:20 to 4:00 hrs Default: OFF	PRIORITY OVERRIDE The amount of time priority is given for indirect DHW or setpoint operation before space heating resumes. This item is only available when Application Mode is set to RSET or EMS, & Indirect DHW Mode is set to ON & Indirect DHW Priority is set to ON, or Setpoint Mode is set to ON & Setpoint Priority is set to ON.
	35 to 100°F, OFF (2.0 to 38.0°C) Default: 70°F (21.0°C)	WWSD OCCUPIED The system's warm weather shutdown temperature during the occupied periods. This item is only available when the Application Mode is set to RSET.
	35 to 100°F, OFF (2.0 to 38.0°C) Default: 60°F (15.5°C)	WWSD UNOCCUPIED The system's warm weather shutdown temperature during the unoccupied periods. This item is only available when the Application Mode is set to RSET & the Setback / Off switch is set to Setback.
	OFF, 3 to 40 min Default: 20 min	BOILER ALERT Alert signal if the boiler supply temperature does not increase in temperature, after all available boilers have been turned on, within the selected time.
	OFF or ON Default: OFF	FLOW SENSOR Selects whether or not a flow sensor is used.
	0 to 100 gpm Default: 0 gpm	FLOW RATE 4MA Sets the flow rate that corresponds to 4 mA for the flow sensor. This item is only available when Flow Sensor is set to ON.
	100 to 2,000 gpm Default: 500 gpm	FLOW RATE 20MA Sets the flow rate that corresponds to 20 mA for the flow sensor. This item is only available when Flow Sensor is set to ON.
	OFF, 1 to 100% Default: OFF	FLOW SENSOR PROOF Sets the percentage of flow used for proving primary pump flow. If the flow sensor is only used for monitoring, set to OFF. This is the minimum flow required to prove primary pump flow. This item is only available when Flow Sensor is set to ON.
	OFF or ON Default: OFF	PRESSURE SENSOR Selects whether or not a pressure sensor is used.
	50, 100, 150, 200, 250, 300 Default: 50	PRESSURE SENSOR RANGE Selects the model of pressure sensor based on the pressure range in units of PSI. This item is only available when Pressure Sensor is set to ON.

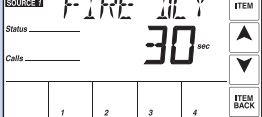
Source # Menu (1 of 2)

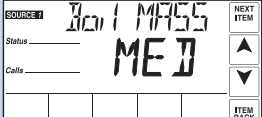
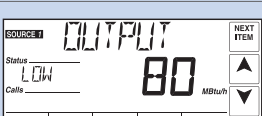
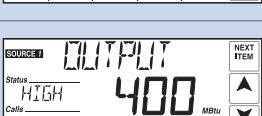
There is a different Source Menu for each of the 4 boilers that the 284 can operate. Settings can vary for each boiler if desired.

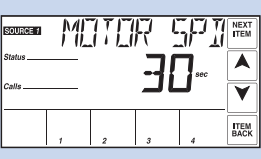
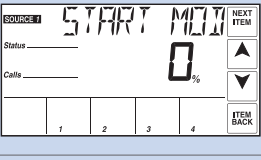
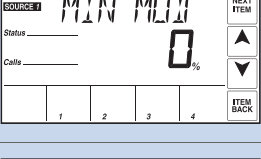
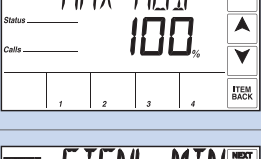
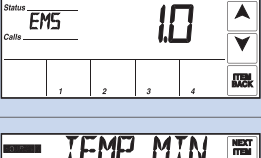
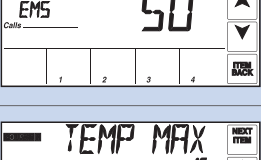
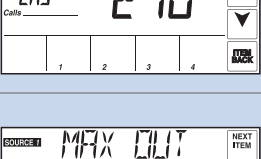

	<p>OFF or AUTO Default: AUTO for Boil1 OFF for Boiler 2-4</p>	<p>BOILER ENABLE Selects whether the boiler is operational or not.</p>
	<p>OFF or Boil1 Default: OFF</p>	<p>COPY BOILER 1 Selects whether or not settings from boiler 1 are copied to Boiler 2, 3 & 4. This item is applicable for Boiler 2, 3 and 4 and is only available if Boiler Enable is set to AUTO.</p>
	<p>NO or YES Default: NO</p>	<p>BOILER CONDENSE Selects if the boiler is non-condensing (NO) or condensing (YES). This item is only available if Boiler Enable is set to AUTO & Copy Boiler 1 is set to OFF.</p>
	<p>MOD, 1STG, 2STG, EMS Default: MOD</p>	<p>BOILER TYPE Selects from the different types of burner operation including modulating direct drive (MOD), single stage (1STG), two stage (2STG) & target temperature (EMS). This item is only available if Boiler Enable is set to AUTO & Copy Boiler 1 is set to OFF.</p>
	<p>0-10 or 4-20 Default: 0-10</p>	<p>MODULATION TYPE Selects either 0-10 Vdc (0-10) or 4-20 mA (4-20) as the analog output for the modulating boiler. This item is only available if Boiler Enable is set to AUTO, Copy Boiler 1 is set to OFF & Boiler Type is set to MOD or EMS.</p>
	<p>10 to 180 sec Default: 30 sec</p>	<p>FIRE DELAY Delay from turn-on of ignition until the burner obtains flame. This item is only available if Boiler Enable is set to AUTO & Copy Boiler 1 is set to OFF.</p>
	<p>OFF, 10 to 180 sec Default: OFF</p>	<p>MODULATION DELAY Delay between the burner obtaining flame & the boiler's ignition control releasing to modulation. This item is only available if Boiler Enable is set to AUTO, Copy Boiler 1 is set to OFF & Boiler Type is set to MOD.</p>
	<p>LOW, MED, HI Default: MED</p>	<p>BOILER MASS The thermal mass characteristics of the boiler. This item is only available if Boiler Enable is set to AUTO & Copy Boiler 1 is set to OFF.</p>
	<p>10 to 9990 MBtu/h Default: 80 MBtu/h</p>	<p>BOILER OUTPUT LOW Minimum (low fire) heat output in Btu/hr/1000. This item is only available if Boiler Enable is set to AUTO, Copy Boiler 1 is set to OFF & Boiler Type is set to MOD.</p>
	<p>10 to 9990 MBtu/h Default: 400 MBtu/h</p>	<p>BOILER OUTPUT HIGH Maximum (high fire) heat output in Btu/hr/1000. This item is only available if Boiler Enable is set to AUTO & Copy Boiler 1 is set to OFF.</p>

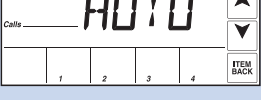
Source # Menu (2 of 2)

 <p>SOURCE: MOTOR SPD Status: _____ Calls: _____ 30^{sec} 1 2 3 4 NEXT ITEM ITEM BACK</p>	<p>10 to 230 sec Default: 30 sec Access: ADV</p>	<p>MOTOR SPEED The amount of time required for the modulating actuating motor to fully open the gas valve or operate the blower from a stopped position to full speed. This item is only available if Boiler Enable is set to AUTO, Boiler 1 Copy is set to OFF & Boiler Type is set to MOD.</p>
 <p>SOURCE: START MOD Status: _____ Calls: _____ 0% 1 2 3 4 NEXT ITEM ITEM BACK</p>	<p>0 to 100% Default: 0% Access: ADV</p>	<p>START MODULATION The percentage modulation required for ignition. This item is only available if Boiler Enable is set to AUTO, Boiler 1 Copy is set to OFF & Boiler Type is set to MOD.</p>
 <p>SOURCE: MIN MOD Status: _____ Calls: _____ 0% 1 2 3 4 NEXT ITEM ITEM BACK</p>	<p>0 to 50% Default: 0% Access: ADV</p>	<p>MINIMUM MODULATION The minimum percentage modulation of the burner. This item is only available if Boiler Enable is set to AUTO, Boiler 1 Copy is set to OFF & Boiler Type is set to MOD.</p>
 <p>SOURCE: MAX MOD Status: _____ Calls: _____ 100% 1 2 3 4 NEXT ITEM ITEM BACK</p>	<p>50 to 100% Default: 100% Access: ADV</p>	<p>MAXIMUM MODULATION The maximum percentage modulation of the burner. This item is only available if Boiler Enable is set to AUTO, Boiler 1 Copy is set to OFF & Boiler Type is set to MOD.</p>
 <p>SOURCE: SIGNAL MIN Status: EMS Calls: _____ 1.0 1 2 3 4 NEXT ITEM ITEM BACK</p>	<p>0.5 to 10.0 Default: 1.0 Access: ADV</p>	<p>EMS SIGNAL MINIMUM The minimum analog signal used for the EMS (temperature input) boiler and corresponds to the EMS Temperature Minimum. This item is only available if Boiler Enable is set to AUTO, Boiler 1 Copy is set to OFF, Boiler Type is set EMS & Modulation Type is set to 0-10.</p>
 <p>SOURCE: TEMP MIN Status: EMS Calls: _____ 50°F 1 2 3 4 NEXT ITEM ITEM BACK</p>	<p>50 to 210°F, OFF (10.0 to 99.0°C) Default: 50°F Access: ADV</p>	<p>EMS TEMPERATURE MINIMUM The temperature that corresponds to the bottom rail (minimum) of the analog signal (4 mA / Vdc Signal Minimum) used for the EMS (temperature input) boiler. This item is only available if Boiler Enable is set to AUTO, Boiler 1 Copy is set to OFF & Boiler Type is set to EMS.</p>
 <p>SOURCE: TEMP MAX Status: EMS Calls: _____ 210°F 1 2 3 4 NEXT ITEM ITEM BACK</p>	<p>50 to 210°F, OFF (10.0 to 99.0°C) Default: 210°F Access: ADV</p>	<p>EMS TEMPERATURE MAXIMUM The temperature that corresponds to the top rail (maximum) of the analog signal (20 mA / 10.0 Vdc) used for the EMS (temperature input) boiler. This item is only available if Boiler Enable is set to AUTO, Boiler 1 Copy is set to OFF & Boiler Type is set to EMS.</p>
 <p>SOURCE: MAX OUT Status: _____ Calls: _____ OFF 1 2 3 4 NEXT ITEM ITEM BACK</p>	<p>120 to 240°F, OFF (49.0 to 115.5°C, OFF) Default: OFF Access: ADV</p>	<p>MAXIMUM OUTLET TEMPERATURE The maximum boiler outlet temperature used for boiler outlet temperature limiting. The control will turn off the boiler if the boiler outlet temperature rises to the maximum outlet temperature. If OFF is selected, the control will only monitor the boiler outlet temperature. This item is only available if Boiler Enable is set to AUTO & the Boiler 1 Copy is set to OFF.</p>
 <p>SOURCE: POST PURGE Status: _____ Calls: _____ AUTO 1 2 3 4 NEXT ITEM ITEM BACK</p>	<p>OFF, AUTO, 0:10 to 20:00 min Default: AUTO Access: ADV</p>	<p>BOILER PUMP/VALVE POST PURGE The time the boiler pump remains on (or isolation valve remains open) once the boiler turns off. If Auto is selected the control will automatically determine the time. This item is only available if Boiler Enable is set to AUTO & the Boiler 1 Copy is set to OFF.</p>

BAS Menu (1 of 2)

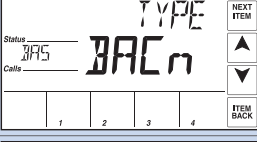
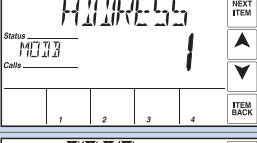
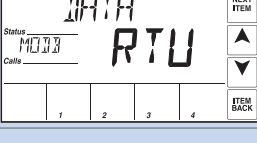
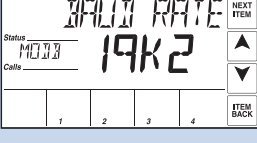
Configure Modbus® & BACnet® options.

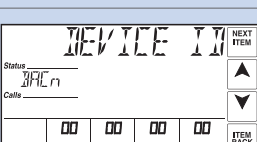
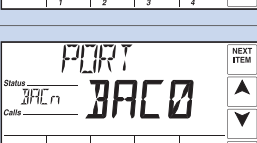
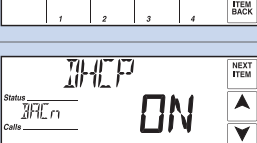
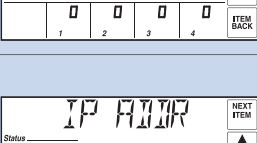
Item Field	Range	Description
	OFF or ON Default: OFF <hr/> Access: ADV	BAS MONITOR Selects whether or not BAS monitor mode is to be used. Monitor mode allows for read / write capability of select menu items. This item is only available when Application Mode is set to either RSET, SETP, DDHW or EMS.
	BACn, MODB Default: BACn <hr/> Access: ADV	BAS TYPE Selects the communication protocol used with the BAS network. Modbus® communicates over RS485 & BACnet® is over IP.
	1 to 247 Default: 1 <hr/> Access: ADV	MODBUS ADDRESS Sets the unique address within the Modbus® network. This item is only available when BAS Type is set to MODB.
	RTU or ASCII Default: RTU <hr/> Access: ADV	MODBUS DATA Selects whether the Modbus® data communication type is RTU or ASCII (ASC). This item is only available when BAS Type is set to MODB.
	2400, 9600, 19K2, 57K6, 115K Default: 19K2 <hr/> Access: ADV	MODBUS BAUD RATE Selects the communication speed. In order to ensure reliable communications, the baud rate on the control must be same as the Modbus® network. This item is only available when BAS Type is set to MODB.
	NONE, EVEN, ODD Default: EVEN <hr/> Access: ADV	MODBUS PARITY Selects the parity used for the Modbus® communication. This item is only available when BAS Type is set to MODB.
	0 to 4, 0 to 99, 0 to 99, 0 to 99 Default: 0, 0, 0, 0 <hr/> Access: ADV	BACNET DEVICE ID Sets the unique address within the BACnet® network. The address is set using four number sets displayed in the source output fields. Touch the 'Next Item' button to view & adjust each number set. This item is only available when BAS Type is set to BACn.
	0x1 to 0xFFFF Default: 0xBAC0 (47808) <hr/> Access: ADV	BACNET PORT Sets the User Datagram Port (UDP) port on the BACnet® network. This item is only available when BAS Type is set to BACn.
	OFF or ON Default: ON <hr/> Access: ADV	BACNET DHCP Selects whether or not the Dynamic Host Configuration Protocol (DHCP) is used to automatically assign the IP address on the BACnet® network. If ON is selected, the address is displayed in the source output fields. This item is only available when BAS Type is set to BACn.
	0 to 255, 0 to 255, 0 to 255, 1 to 254 Default: 192,168,0,200 <hr/> Access: ADV	BACNET IP ADDRESS Sets the IP address on the BACnet® network. The address is set using four number sets displayed in the source output fields. Touch the 'Next Item' button to view & adjust each number set. Touch the 'Next Item' button to view & adjust each number set. This item is only available when BAS Type is set to BACn & BACn DHCP is set to OFF.

BAS Menu (2 of 2)

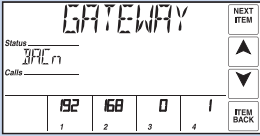
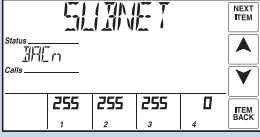
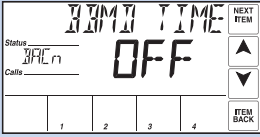
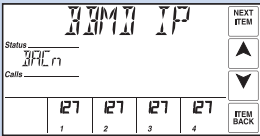
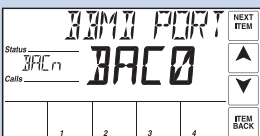
Item Field	Range	Description
 <p>The screenshot shows the 'BACNET GATEWAY' menu. The title is 'BACNET GATEWAY'. Below it, the status is 'BACn' and 'Calls' is 'OFF'. There are four input fields for the IP address: 192, 168, 0, and 1. To the right of the fields are 'NEXT ITEM' (up arrow), 'ITEM BACK' (down arrow), and 'ITEM BACK' (left arrow) buttons.</p>	<p>0 to 255, 0 to 255, 0 to 255, 1 to 254 Default: 192,168,0,1 Access: ADV</p>	<p>BACNET GATEWAY Sets the Gateway address on the BACnet® network. The address is set using four number sets displayed in the source output fields. Touch the 'Next Item' button to view & adjust each number set. Touch the 'Next Item' button to view & adjust each number set. This item is only available when BAS Type is set to BACn & BACn DHCP is set to OFF.</p>
 <p>The screenshot shows the 'BACNET SUBNET' menu. The title is 'BACNET SUBNET'. Below it, the status is 'BACn' and 'Calls' is 'OFF'. There are four input fields for the subnet address: 255, 255, 255, and 0. To the right of the fields are 'NEXT ITEM' (up arrow), 'ITEM BACK' (down arrow), and 'ITEM BACK' (left arrow) buttons.</p>	<p>0 to 255, 0 to 255, 0 to 255, 0 to 255 Default: 255,255,255,0 Access: ADV</p>	<p>BACNET SUBNET Sets the subnet address on the BACnet® network. The address is set using four number sets displayed in the source output fields. Touch the 'Next Item' button to view & adjust each number set. Touch the 'Next Item' button to view & adjust each number set. This item is only available when BAS Type is set to BACn & BACn DHCP is set to OFF.</p>
 <p>The screenshot shows the 'BACNET BBMD TIME' menu. The title is 'BACNET BBMD TIME'. Below it, the status is 'BACn' and 'Calls' is 'OFF'. There are four input fields, all showing 'OFF'. To the right of the fields are 'NEXT ITEM' (up arrow), 'ITEM BACK' (down arrow), and 'ITEM BACK' (left arrow) buttons.</p>	<p>OFF, 30 to 65535 Default: OFF Access: ADV</p>	<p>BACNET BBMD TIME Sets the BACnet® Broadcast Management Device (BBMD) time-to-live used for foreign device registration. This item is only available when BAS Type is set to BACn & DHCP is set to ON.</p>
 <p>The screenshot shows the 'BACNET BBMD IP' menu. The title is 'BACNET BBMD IP'. Below it, the status is 'BACn' and 'Calls' is 'OFF'. There are four input fields for the IP address: 127, 127, 127, and 127. To the right of the fields are 'NEXT ITEM' (up arrow), 'ITEM BACK' (down arrow), and 'ITEM BACK' (left arrow) buttons.</p>	<p>0 to 255, 0 to 255, 0 to 255, 0 to 255 Default: 127,127,127,127</p>	<p>BACNET BBMD IP Sets the BBMD IP address on the BACnet® network. The address is set using four number sets displayed in the source output fields. Touch the 'Next Item' button to view & adjust each number set. Touch the 'Next Item' button to view & adjust each number set. This item is only available when BAS Type is set to BACn & BACnet® BBMD Time is not set to OFF.</p>
 <p>The screenshot shows the 'BACNET BBMD PORT' menu. The title is 'BACNET BBMD PORT'. Below it, the status is 'BACn' and 'Calls' is 'OFF'. There are four input fields for the port address: B, A, C, 0. To the right of the fields are 'NEXT ITEM' (up arrow), 'ITEM BACK' (down arrow), and 'ITEM BACK' (left arrow) buttons.</p>	<p>0x1 to 0xFFFF Default: 0xBAC0 (47808) Access: Adv</p>	<p>BACNET BBMD PORT Sets the BBMD UDP port on the BACnet® network. This item is only available when BAS Type is set to BACn & BACnet® BBMD Time is not set to OFF.</p>

Monitor # Menu (1 of 1)

Monitor (#) items are repeated for each available boiler.





Item Field	Range	Description
	0 to 65535 hours <i>Access: ADV</i>	BURNER RUN TIME The total running time of the boiler since this item was last cleared. Press & hold the 'CLEAR' button while viewing to reset. This item is only available when Boiler Enable is set to AUTO.
	0 to 65535 hours <i>Access: ADV</i>	BOILER PUMP / VALVE RUN TIME The total running time of the boiler pump / valve since this item was cleared. Press & hold the 'CLEAR' button while viewing to reset. This item is only available when Boiler Enable is set to AUTO.
	0 to 65535 <i>Access: ADV</i>	BOILER CYCLES The total number of boiler cycles since this item was cleared. Press & hold the 'CLEAR' button while viewing to reset. This item is only available when Boiler Enable is set to AUTO.
	-22 to 266°F (-30.0 to 130.0°C) <i>Access: ADV</i>	BOILER OUTLET HIGH Records the highest boiler outlet temperature since this item was last cleared. Press & hold the 'CLEAR' button while viewing to reset. This item is only available when Boiler Enable is set to AUTO & a boiler outlet sensor is connected.
	-22 to 266°F (-30.0 to 130.0°C) <i>Access: ADV</i>	BOILER OUTLET LOW Records the lowest boiler outlet temperature since this item was last cleared. Press & hold the 'CLEAR' button while viewing to reset. This item is only available when Boiler Enable is set to AUTO & a boiler outlet sensor is connected.
	-22 to 266°F (-12.0 to 148.0°C) <i>Access: ADV</i>	BOILER TEMPERATURE DIFFERENCE HIGH Records the highest temperature difference between the boiler inlet & boiler outlet sensors since this item was cleared. Press & hold the 'CLEAR' button while viewing to reset. This item is only available when Boiler Enable is set to AUTO & boiler outlet & boiler inlet sensors are connected.

Monitor Menu (1 of 2)

This Monitor Menu displays items that are not specific to one boiler.

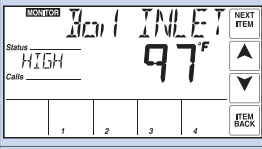
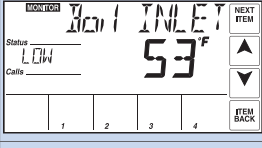
Item Field	Range	Description
	0 to 65535 Therms <i>Access: ADV</i>	ENERGY Total calculated energy being delivered to the load since this item was last cleared. Press & hold the 'CLEAR' button while viewing to reset. This item is only available when Flow Sensor is set to ON & a boiler return sensor is connected.
	0 to 65535 hours <i>Access: ADV</i>	PRIMARY PUMP 1 RUN TIME The total running time of primary pump 1 since this item was cleared. Press & hold the 'CLEAR' button while viewing to reset.
	0 to 65535 hours <i>Access: ADV</i>	PRIMARY PUMP 2 RUN TIME The total running time of primary pump 2 since this item was cleared. Press & hold the 'CLEAR' button while viewing to reset.
	0 to 65535 hours <i>Access: ADV</i>	DHW PUMP RUN TIME The total running time of the IDHW pump since this item was cleared. Press & hold the 'CLEAR' button while viewing to reset.
	-22 to 266°F (-30.0 to 130.0°C) <i>Access: ADV</i>	BOILER SUPPLY HIGH Records the highest boiler supply temperature since this item was last cleared. Press & hold the 'Clear' button while viewing to reset.
	-22 to 266°F (-30.0 to 130.0°C) <i>Access: ADV</i>	BOILER SUPPLY LOW Records the lowest boiler supply temperature since this item was last cleared. Press & hold the 'CLEAR' button while viewing to reset.
	-22 to 266°F (-30 to 130°C) <i>Access: ADV</i>	BOILER RETURN HIGH Records the highest boiler return temperature since this item was last cleared. Press & hold the 'CLEAR' button while viewing to reset. This item is only available when a boiler return sensor is connected.
	-22 to 266°F (-30.0 to 130.0°C) <i>Access: ADV</i>	BOILER RETURN LOW Records the lowest boiler return temperature since this item was last cleared. Press & hold the 'CLEAR' button while viewing to reset. This item is only available when a boiler return sensor is connected.
	-22 to 266°F (-12.0 to 148.0°C) <i>Access: ADV</i>	SUPPLY TEMPERATURE DIFFERENCE HIGH Records the highest temperature difference between the boiler supply & boiler return sensors since this item was cleared. Press & hold the 'CLEAR' button while viewing to reset. This item is only available when the boiler supply & boiler return sensors are connected.
	0 to 65535 gpm <i>Access: ADV</i>	FLOW RATE HIGH Records the highest flow rate from the flow sensor since this item was last cleared. Press & hold the 'CLEAR' button while viewing to reset. This item is only available when Flow Sensor is set to ON.
	0 to 65535 psi <i>Access: ADV</i>	PRESSURE HIGH Records the highest pressure since this item was last cleared. Press & hold the 'CLEAR' button while viewing to reset. This item is only available when Pressure Sensor is set to ON.

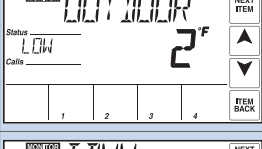
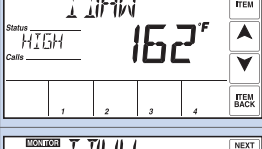
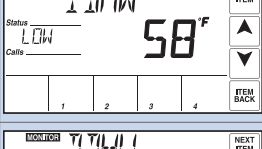
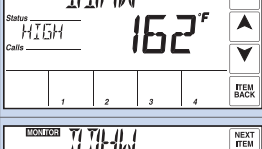
Monitor Menu (2 of 2)

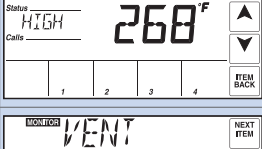
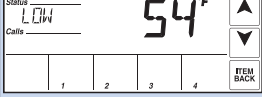
Item Field	Range	Description
 <p>MONITOR: BOILER INLET Status: HIGH Calls: 97°F NEXT ITEM: ▲ ITEM BACK: ▼</p>	<p>-22 to 266°F (-30.0 to 130.0°C)</p> <p>Access: ADV</p>	<p>BOILER INLET HIGH Records the highest boiler inlet temperature since this item was last cleared. Press & hold the 'CLEAR' button while viewing to reset. This item is only available when a boiler inlet sensor is connected.</p>
 <p>MONITOR: BOILER INLET Status: LOW Calls: 53°F NEXT ITEM: ▲ ITEM BACK: ▼</p>	<p>-22 to 266°F (-30.0 to 130.0°C)</p> <p>Access: ADV</p>	<p>BOILER INLET LOW Records the lowest boiler inlet temperature since this item was last cleared. Press & hold the 'CLEAR' button while viewing to reset. This item is only available when a boiler inlet sensor is connected.</p>
 <p>MONITOR: OUTDOOR Status: HIGH Calls: 102°F NEXT ITEM: ▲ ITEM BACK: ▼</p>	<p>-76 to 149°F (-60.0 to 65.0°C)</p> <p>Access: ADV</p>	<p>OUTDOOR HIGH Records the highest outdoor temperature since this item was last cleared. Press & hold the 'CLEAR' button while viewing to reset. This item is only available when an outdoor sensor is connected.</p>
 <p>MONITOR: OUTDOOR Status: LOW Calls: 2°F NEXT ITEM: ▲ ITEM BACK: ▼</p>	<p>-76 to 149°F (-60.0 to 65.0°C)</p> <p>Access: ADV</p>	<p>OUTDOOR LOW Records the lowest outdoor temperature since this item was last cleared. Press & hold the 'CLEAR' button while viewing to reset. This item is only available when an outdoor sensor is connected.</p>
 <p>MONITOR: INDIRECT DHW Status: HIGH Calls: 162°F NEXT ITEM: ▲ ITEM BACK: ▼</p>	<p>-22 to 266°F (-30.0 to 130.0°C)</p> <p>Access: ADV</p>	<p>INDIRECT DHW HIGH Records the highest indirect DHW temperature since this item was last cleared. Press & hold the 'CLEAR' button while viewing to reset. This item is only available when Application Mode is not set to BAS, Indirect DHW Mode is set to ON & Indirect DHW Sensor is set to ON.</p>
 <p>MONITOR: INDIRECT DHW Status: LOW Calls: 58°F NEXT ITEM: ▲ ITEM BACK: ▼</p>	<p>-22 to 266°F (-30.0 to 130.0°C)</p> <p>Access: ADV</p>	<p>INDIRECT DHW LOW Records the lowest indirect DHW temperature since this item was last cleared. Press & hold the 'CLEAR' button while viewing to reset. This item is only available when Application Mode is not set to BAS, Indirect DHW Mode is set to ON & Indirect DHW Sensor is set to ON.</p>
 <p>MONITOR: DIRECT DHW Status: HIGH Calls: 162°F NEXT ITEM: ▲ ITEM BACK: ▼</p>	<p>-22 to 266°F (-30.0 to 130.0°C)</p> <p>Access: ADV</p>	<p>DIRECT DHW HIGH Records the highest direct DHW temperature (boiler supply sensor) since this item was last cleared. Press & hold the 'CLEAR' button while viewing to reset. This item is only available when Application Mode is set to DDHW.</p>
 <p>MONITOR: DIRECT DHW Status: LOW Calls: 50°F NEXT ITEM: ▲ ITEM BACK: ▼</p>	<p>-22 to 266°F (-30.0 to 130.0°C)</p> <p>Access: ADV</p>	<p>DIRECT DHW LOW Records the lowest direct DHW temperature (boiler supply sensor) since this item was last cleared. Press & hold the 'CLEAR' button while viewing to reset. This item is only available when Application Mode is set to DDHW.</p>
 <p>MONITOR: VENT Status: HIGH Calls: 268°F NEXT ITEM: ▲ ITEM BACK: ▼</p>	<p>-40 to 500°F (-40.0 to 260.0°C)</p> <p>Access: ADV</p>	<p>VENT HIGH Records the highest vent temperature since this item was last cleared. Press & hold the 'CLEAR' button while viewing to reset. This item is only available when a vent sensor is connected.</p>
 <p>MONITOR: VENT Status: LOW Calls: 54°F NEXT ITEM: ▲ ITEM BACK: ▼</p>	<p>-40 to 500°F (-40.0 to 260.0°C)</p> <p>Access: ADV</p>	<p>VENT LOW Records the lowest vent temperature since this item was last cleared. Press & hold the 'CLEAR' button while viewing to reset. This item is only available when a vent sensor is connected.</p>

Time Menu (1 of 1)

The Time menu sets the time & date.

The **Setback / Off** switch setting must be in the **Setback** position in order to have access to the Time menu.



Set minutes.

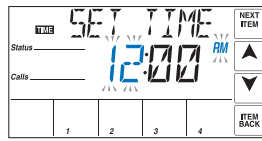

Set hours, then select AM or PM. For a 24 hr clock, AM / PM is not displayed.



Set date.

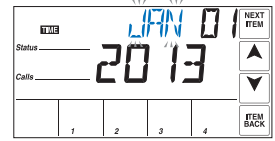

Set month.



Set year.

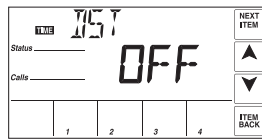

Turn daylight savings time ON if an automatic time change is required.

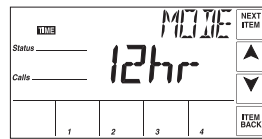

Select 12 or 24 hr clock.

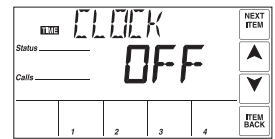

Select On or Off. If On is selected, the Time will be displayed in the View menu.



Schedule Menu (1 of 1)

The 284 can follow an internal schedule or an available schedule on a tekmarNet® network. Four heating schedules can be present on one network. The number of available schedule times depends on selections made for the Heat Schedule, Schedule Type & Events / Day settings.

Schedule Type				
Day	24 Hour	5-2	5-11	7 day
Sa			•	•
Su		•	•	•
Mo				•
Tu	•			•
We		•	•	•
Th				•
Fr				•

Default Times

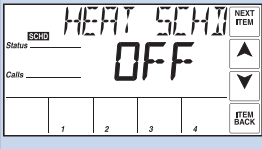
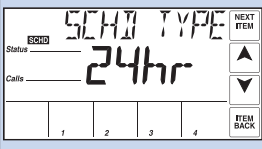
Events / Day	Event	24Hr	Sat	Sun	Mon	Tue	Wed	Thu	Fri
4	Occupied 1	6:00 AM	6:00 AM	6:00 AM	6:00 AM	6:00 AM	6:00 AM	6:00 AM	6:00 AM
	UnOccupied 1	8:00 AM	8:00 AM	8:00 AM	8:00 AM	8:00 AM	8:00 AM	8:00 AM	8:00 AM
	Occupied 2	6:00 PM	6:00 PM	6:00 PM	6:00 PM	6:00 PM	6:00 PM	6:00 PM	6:00 PM
	UnOccupied 2	10:00 PM	10:00 PM	10:00 PM	10:00 PM	10:00 PM	10:00 PM	10:00 PM	10:00 PM
or									
2	Occupied	6:00 AM	6:00 AM	6:00 AM	6:00 AM	6:00 AM	6:00 AM	6:00 AM	6:00 AM
	Unoccupied	10:00 PM	10:00 PM	10:00 PM	10:00 PM	10:00 PM	10:00 PM	10:00 PM	10:00 PM

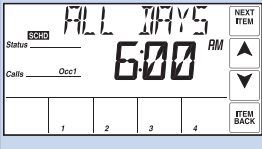
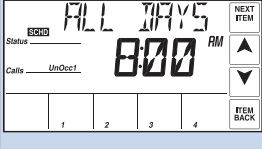
Item Field	Range	Description
	OFF, CTRL, MST1, MST2, MST3, MST4, MBR1, MBR2, MBR3, MBR4 Default = OFF <hr/> Access: USER	HEAT SCHEDULE OFF = No schedule. CTRL = Schedule only used by this control. MST1 to MST4 = Schedule is shared with other tN4 devices. MBR1 to MBR4 = Schedule is set on another tN4 device. This item is only available when the Setback / Off switch is set to Setback.
	24hr, 5-2, 5-11, 7DAY Default = 24hr <hr/> Access: USER	SCHEDULE TYPE 24hr = One schedule for all days of the week. 5-2 = One schedule for weekdays & one for weekends. 5-11 = One schedule for weekdays, one for Saturday & one for Sunday. 7DAY = A schedule for each day of the week. This item is only available when the Setback / Off switch is set to Setback & the Heat Schedule is set to CTRL or MST1 to MST4.
	2 or 4 Default = 2 <hr/> Access: USER	EVENTS / DAY 2 = 2 Events per day (Occ, Unocc) 4 = 4 events per day (Occ 1, Unocc 1, Occ 2, Unocc 2) This item is only available when the Setback / Off switch is set to Setback & the Heat Schedule is set to CTRL or MST1 to MST4.
	12:00AM to 11:50PM, SKIP or 00:00 to 23:50, SKIP Default = 6:00AM <hr/> Access: USER	OCCUPIED START TIME (ALL DAYS, MON-FRI, SAT-SUN) Select the time for the Occupied period to start. Additional occupied event times are available depending on the schedule type & mode settings. This item is only available when the Setback / Off switch is set to Setback, Heat Schedule is set to CTRL or MST1 to MST4.
	12:00AM to 11:50PM, SKIP or 00:00 to 23:50, SKIP Default = 8:00AM <hr/> Access: USER	UNOCCUPIED START TIME (ALL DAYS, MON-FRI, SAT-SUN) Select the time for the Unoccupied period to start. Additional unoccupied event times are available depending on the schedule type & mode settings. This item is only available when the Setback / Off switch is set to Setback, Heat Schedule is set to CTRL or MST1 to MST4.

Toolbox Menu (1 of 2)

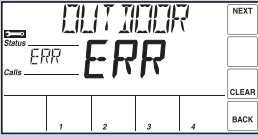
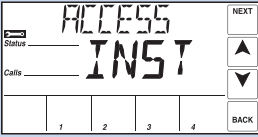
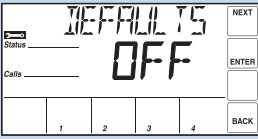
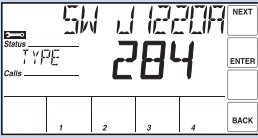
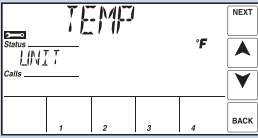
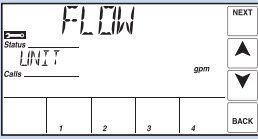
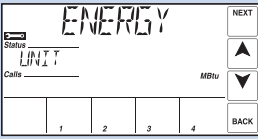
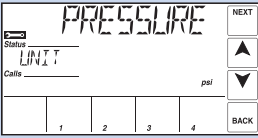
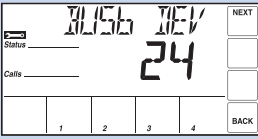
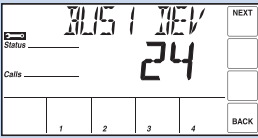
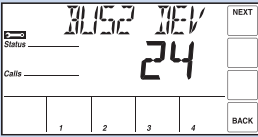
Item Field	Range	Description
	Error Display Access: ---	ERROR If an error is present, it will be displayed as the first item in the toolbox menu. Additional troubleshooting information scrolls on the display. For more information about error messages, refer to the Error Messages section of this document.
	USER, INST, ADV Default: INST Access: <i>USER</i>	ACCESS LEVEL The access level of the control. The access column shows which items are visible in each access level. This item is only available if the Lock / Unlock switch is set to Unlock.
	OFF, SEL, DONE Default: OFF Access: <i>ADV</i>	DEFAULT Press the Enter button to show SEL. After 3 seconds DONE will be indicated & factory defaults will be loaded to all settings.
	284, Software Version Access: <i>USER</i>	TYPE & SOFTWARE VERSION Product number of the control displayed in the number field. Software version displayed in the item field.
	°F or °C Default: °F Access: <i>USER</i>	TEMPERATURE UNITS Units for display of temperature.
	gpm or m ³ /h Default: gpm Access: <i>INST</i>	FLOW RATE UNITS Units for display of flow rate. This item is only available if Flow Sensor is set to ON.
	MBtu or kWh Default: MBtu Access: <i>INST</i>	ENERGY UNITS Units for display of Energy. If MBtu is selected, the units used for Energy are Therms (THRM). If kWh is selected, the units used for Energy are Gigajoules (GJ). This item is only available if Flow Sensor is set to ON.
	psi or kPa Default: psi Access: <i>INST</i>	PRESSURE UNITS Units for display of pressure. This item is only available if Pressure Sensor is set to ON.
	1 to 24 Access: <i>INST</i>	BOILER BUS B DEVICES Displays the number of tN4 devices connected to the Boiler Bus b terminals, tN4 & C0 (32 & 33).
	1 to 24 Access: <i>INST</i>	BOILER BUS 1 DEVICES Displays the number of tN4 devices connected to the Boiler Bus 1 terminals, tN4 & C1 (34 & 35).
	1 to 24 Access: <i>INST</i>	BOILER BUS 2 DEVICES Displays the number of tN4 devices connected to the Boiler Bus 2 terminals, tN4 & C2 (36 & 37).

Toolbox Menu (2 of 2) 

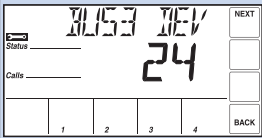
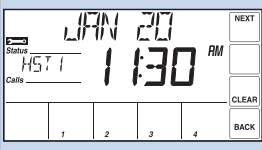
Item Field	Range	Description
	<p>1 to 24</p> <hr/> <p>Access: <i>INST</i></p>	<p>BOILER BUS 3 DEVICES Displays the number of tN4 devices connected to the Boiler Bus 3 terminals, tN4 & C3 (38 & 39).</p>
	<p>The error date & the type of error alternate on the screen</p> <hr/> <p>Access: <i>INST</i></p>	<p>ERROR HISTORY 1-5 Displays a history of any past errors that have occurred on the system. Will automatically clear after 30 days. To manually clear, press 'CLEAR' while viewing the error until CLR is displayed. The last 5 history items will display if present.</p>

Manual Override

Commissioning, testing & troubleshooting features of the 284 are accessed by holding the Manual Override button for 3 seconds. Once an item is selected in this menu, there is a 3 second delay before the feature activates. The Manual Override has five different modes including:

Automatic (AUTO)

The normal operating mode for the control is automatic. The control operates based on the settings, calls & current conditions.

Purge Override (PURG)

In this mode, the control overrides the normal operating mode & operates pumps. This mode is useful for purging air out of the system.

- Primary pump: operation of the primary pump is dependent on the system settings in the Setup menu. Only one enabled primary pump is turned on. If both primary pumps are enabled, primary pump 1 is turned on. If primary pump 1 is disabled & primary pump 2 is enabled, primary pump 2 is turned on. If both primary pumps are disabled, no primary pump is turned on.
- IDHW pump: operation of the IDHW pump is dependent on the system settings in the Setup menu. If IDHW Mode is turned on, the IDHW pump is turned on. If IDHW Mode is turned Off, the IDHW pump is not turned on.
- When in Purge mode, 'PURG' & 'OVR' will scroll in the status field of the display.
- Purge will operate for a fixed period of 72 hours. After the purge period expires the control will revert to Automatic operation. The purge override can also be terminated by selecting the AUTO override mode.

Max Heat Override (MAX)

In this mode, the control overrides the normal operating mode & operates the system to maintain a boiler target temperature of 230°F. This function is useful on start-up & commissioning, & also when drying sheet rock & paint in the building.

- Operation of the equipment is dependent on the system.
- WWSD, IDHW & Setpoint Priority are disabled during Max Heat.
- While in Max Heat mode, 'MAX' & 'HEAT' will scroll in the status field of the display.
- Max Heat will operate for an adjustable timeout period. After the timeout period elapses the control will revert back to Automatic mode. The max heat override can also be terminated by selecting the AUTO override mode.

Hand Override (HAND)

In this mode, the control overrides the normal operating mode & allows for manual operation of the equipment. This mode is useful for testing & assisting with troubleshooting.

- Operation of the equipment is dependent on the settings in the Setup menu. Refer to the 'Selecting a Manual Override Mode' for the sequence of steps.
- While in Hand mode, 'HAND' & 'OVR' will scroll in the status field of the display.
- Hand mode will operate for an adjustable timeout period. After the timeout period elapses the control will revert back to Automatic mode. The hand override can also be terminated by selecting the AUTO override mode.

Off Override (OFF)

In this mode, the control overrides the normal operating mode & forces the entire system off. This mode is useful for conducting maintenance or changeout of mechanical components in the system.

- While in Off mode, 'OFF' & 'OVR' will scroll in the status field of the display.
- The Off override can be terminated at any time by selecting the AUTO override mode.

Selecting a Manual Override Mode

Press & hold for 3 seconds

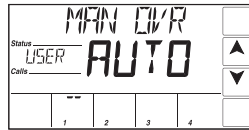

Once an item is selected in this menu, there is a 3 second delay before the feature activates.

Item Field	Range	Description
	AUTO, OFF, HAND, MAX, PURG	MANUAL OVERRIDE Select which mode of manual override to activate.
	1hr to 72hr	TIMEOUT Set the timeout used for the Hand & Maximum Heat manual overrides. This item is only available if Manual Override is set to either HAND or MAX.
	OFF or ON	ALERT Selects manual operation of the Alert relay. This item is only available if Manual Override is set to HAND.
	OFF or ON	AUXILIARY Selects manual operation of the Auxiliary relay. The Auxiliary is defined to be either a C.A. damper or a DHW recirculation pump. This item is only available if Manual Override is set to HAND.
	OFF, PMP1 or PMP2	PRIMARY PUMP Selects manual operation of the primary pump. Only one pump can operate. If a pump is operating & then the other pump is selected, the former pump will turn off while the latter pump remains on. This item is only available if Manual Override is set to HAND.
	OFF or ON	DHW PUMP Selects manual operation of the DHW pump. This item is only available if Manual Override is set to HAND & IDHW Mode is set to ON.
	OFF or ON	BOILER (#) PUMP / VALVE Selects operation of the boiler pump. This item is available for each of the available boilers. This item is only available if Manual Override is set to HAND,
	1STG: OFF or 1 2STG: OFF, 1 or 2	BOILER (#) STG Selects operation of single & two stage boilers. This item is available for each of the available single & two stage boilers. If the boiler pump / valve is not already activated, it will turn on. <ul style="list-style-type: none"> • OFF: boiler off (applicable for single & two stage) • 1: Turn on stage 1 (applicable for single & two stage) • 2: Turn on stage 2 (applicable for two stage) This item is only available if Manual Override is set to HAND & Boiler Enable is set to AUTO & Boiler Type is set to 1STG or 2STG.
	0 to 100%	BOILER (#) MOD Sets percentage modulation for modulating boilers. This item is available for each of the available modulating boilers. If the boiler pump / valve is not already activated, it will turn on. This item is only available if Manual Override is set to HAND & Boiler Enable is set to AUTO & Boiler Type is set to MOD.
	OFF, EMS TEMP MIN to EMS TEMP MAX	BOILER (#) TEMP Sets the target temperature for temperature input boilers. This item is available for each of the available temperature input boilers. If the boiler pump / valve is not already activated, it will turn on. This item is only available if Manual Override is set to HAND & Boiler Enable is set to AUTO & Boiler Type is set to EMS.

Troubleshooting



It is recommended to complete all wiring to ensure trouble free operation. Should an error occur, simply follow these steps:

- Find:** If the Boiler Control 284 flashes  on the screen, it is indicating a problem on the system.
- Identify:** Press & hold the Home button for 3 seconds to view the available menus. Tap the NEXT ITEM button to locate the Toolbox Menu & press ENTER to view the toolbox menu items. The Error code should appear as the first item. The troubleshooting tips will then marquee across the Item field.
- Solve:** Using the lookup chart below, match the Error code to the one on the control. Use the Description & Troubleshooting Tips in the chart to solve the problem.

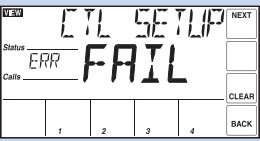
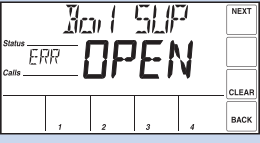
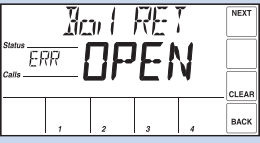
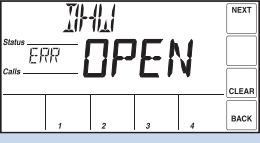
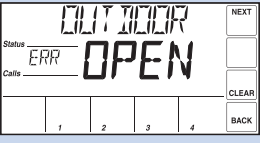
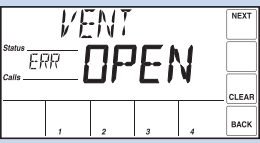
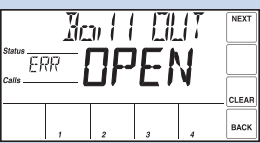

Error Messages (1 of 3)

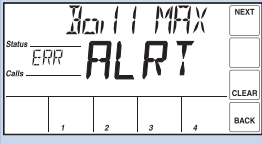
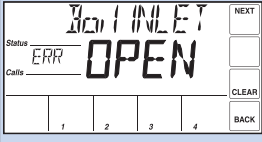
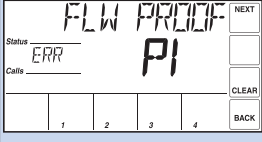
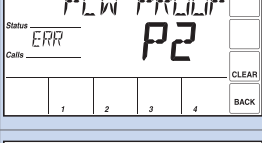
Error Message	Description	Troubleshooting Tips
	<p>CONTROL SETUP FAILURE The control failed to read the Setup menu settings, & reloaded factory default settings. Operation stops until this error message is cleared. To clear, press the 'CLEAR' button while viewing this warning message.</p>	<p>RESET DEFAULTS, VERIFY ALL SETTINGS</p>
	<p>BOILER SUPPLY SENSOR ERROR OPEN or SHRT displays on the screen. Due to an open or short circuit, the control failed to read the boiler supply sensor. As a result, & if available, the control operates using the boiler return sensor. If the boiler return sensor is unavailable, operation stops. The error message self clears once the error condition is corrected.</p>	<p>CHECK BOILER SUPPLY SENSOR, CHECK BOILER SUPPLY SENSOR WIRING</p>
	<p>BOILER RETURN SENSOR ERROR OPEN or SHRT displays on the screen. Due to an open or short circuit, the control failed to read the boiler return sensor. If the Boiler Supply sensor is available, the control will operate normally. If the Boiler Supply sensor is unavailable, the control can only operate to satisfy indirect DHW if its located in the near boiler piping (i.e. IDHW Location = Near). The error message self clears once the error condition is corrected.</p>	<p>CHECK BOILER RETURN SENSOR, CHECK BOILER RETURN SENSOR WIRING</p>
	<p>DHW SENSOR ERROR OPEN or SHRT displays on the screen. Due to an open or short circuit, the control failed to read the DHW sensor. As a result, the control stops operation for DHW heating (indirect or direct DHW). The error message self clears once the error condition is corrected.</p>	<p>CHECK DHW SENSOR, CHECK DHW SENSOR WIRING</p>
	<p>OUTDOOR SENSOR ERROR OPEN or SHRT displays on the screen. Due to an open or short circuit, the control failed to read the outdoor sensor. As a result, the control assumes an outdoor temperature of 32°F (0.0°C) & continues operation. The error message self clears once the error condition is corrected.</p>	<p>CHECK OUTDOOR SENSOR, CHECK OUTDOOR SENSOR WIRING</p>
	<p>VENT SENSOR ERROR OPEN or SHRT displays on the screen. Due to an open or short circuit, the control failed to read the vent sensor. If the Vent Maximum is set to a temperature, the control stops operation. If the Vent Maximum is set to Off, the control continues operation. The error message self clears once the error condition is cleared.</p>	<p>CHECK VENT SENSOR CHECK VENT SENSOR WIRING</p>
	<p>BOILER (#) OUTLET SENSOR ERROR OPEN or SHRT displays on the screen. Due to an open or short circuit, the control failed to read the boiler (#) outlet sensor. The error message self clears once the error condition is cleared.</p>	<p>CHECK BOILER (#) OUTLET SENSOR, CHECK BOILER (#) OUTLET SENSOR WIRING</p>

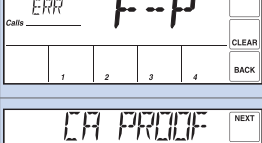
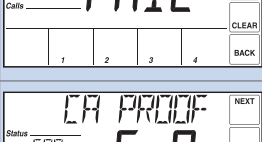
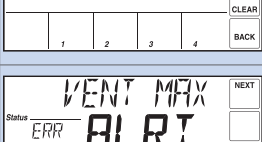
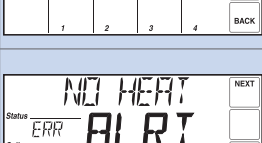
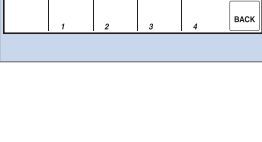
Error Messages (2 of 3)

Error Message	Description	Troubleshooting Tips
	<p>BOILER (#) OUTLET SENSOR MAXIMUM EXCEEDED The boiler outlet (#) temperature exceeded the Maximum Outlet temperature. As a result, the control stops operation for the associated boiler. The error message self clears once the error condition is cleared.</p>	BOILER (#) OUTLET TEMP EXCEEDS MAX OUT SETTING
	<p>BOILER INLET SENSOR ERROR OPEN or SHRT displays on the screen. Due to an open or short circuit, the control failed to read the boiler inlet sensor. The control operates normally while the error message is present. The error message self clears once the error condition is corrected.</p>	CHECK BOILER INLET SENSOR, CHECK BOILER INLET SENSOR WIRING
	<p>PRIMARY PUMP P1 FLOW PROOF FAILURE The primary pump P1 has failed. Once the primary pump 1 relay closed, a flow proof call was call not detected before the flow proof delay time elapsed.</p>	CHECK FLOW PROVING DEVICE, CHECK FLOW PROVING DEVICE WIRING
	<p>PRIMARY PUMP P2 FLOW PROOF FAILURE The primary pump P2 has failed. Once the primary pump 2 relay closed, a flow proof call was call not detected before the flow proof delay time elapsed.</p>	CHECK FLOW PROVING DEVICE, CHECK FLOW PROVING DEVICE WIRING
	<p>PRIMARY PUMP P1 & P2 FLOW PROOF FAILURE Both the primary pump P1 & P2 have failed.</p>	CHECK FLOW PROVING DEVICE, CHECK FLOW PROVING DEVICE WIRING
	<p>FLOW PROOF CALL ERROR The primary pump has been turned off but the flow proof call remains detected after 4 minutes.</p>	CHECK FLOW PROVING DEVICE, CHECK FLOW PROVING DEVICE WIRING
	<p>COMBUSTION AIR PROOF FAILURE The combustion air damper has failed. The C.A. (Aux) relay closed, but the control did not detect a C.A. proof call before the C.A. proof delay time elapsed.</p>	CHECK CA PROVING DEVICE, CHECK CA PROVING DEVICE WIRING
	<p>COMBUSTION AIR PROOF CALL ERROR The combustion air damper has been turned off but the C.A. proof call remains detected after 4 minutes.</p>	CHECK CA PROVING DEVICE, CHECK CA PROVING DEVICE WIRING
	<p>VENT MAXIMUM EXCEEDED The Vent Sensor temperature has exceeding the VENT MAX setting. As a result, the control stops operation for the entire plant.</p>	VENT TEMP EXCEEDS MAX SETTING
	<p>NO HEAT ALERT The boiler supply temperature did not increase within the boiler alert time. The control operates normally while this Alert is present. To reset the Alert, press the 'CLEAR' button while viewing this warning message.</p>	NO CHANGE IN SUPPLY TEMP WITHIN SPECIFIED PERIOD OF TIME

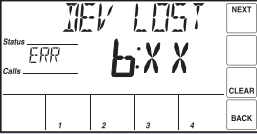
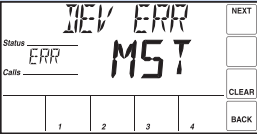
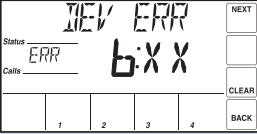
Error Messages (3 of 3)

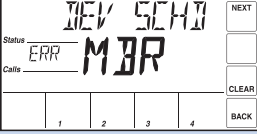
Error Message	Description	Troubleshooting Tips
	<p>tekmarNet® DEVICE LOST Communication is lost to a tN4 device on one of the four Boiler Buses (b, 1, 2, 3). The number shown is the address of the lost device. The display on the lost device displays Bus Boil Opn. Ensure that there is power to the lost device. Trace the wires from the control to the lost device looking for loose or damaged wires. The error message self clears when the error condition is corrected. If the tN4 device is deliberately removed, press the 'CLEAR' button while viewing this error message/</p>	<p>DEVICE MISSING ON TN4 BUS (#)</p>
	<p>tekmarNet® DUPLICATE MASTER ERROR More than one tN4 system control has been detected on the tN4 Boiler Bus. The 284 is a "Master Device" & no other tekmarNet reset controls can be added to the tN4 Boiler Bus terminals. If one has been added it must be removed from the system.</p>	<p>DUPLICATE MASTER CONTROL DETECTED ON TN4 BUS</p>
	<p>tekmarNet® DEVICE ERROR #:## #:## is the address of the device with the error. The bus number displays before the colon, & the device number display after. Go to the device with the address displayed. <i>Possible addresses:</i> b:01 to b:24 - Device Error on Boiler Bus b 1:01 to 1:24 - Device Error on Boiler Bus 1 2:01 to 2:24 - Device Error on Boiler Bus 2 3:01 to 3:24 - Device Error on Boiler Bus 3</p>	<p>DEVICE ERROR ON TN4 BUS (#)</p>
	<p>tekmarNet® DUPLICATE SCHEDULE MASTER ERROR More than one tN4 device has been assigned the same master number. The control operates using the Occupied settings while this error is present. To clear this error, select a different Schedule Master number, set a different Schedule Member number, set the Schedule to Control, or set the Schedule to None.</p>	<p>DUPLICATE MASTER SCHEDULE DETECTED ON TN4 BUS</p>
	<p>tekmarNet® SCHEDULE MEMBER ERROR The control can no longer detect its schedule master. The control operates using the Occupied settings while this error is present. To clear this error, select a different Schedule Member number, set the Schedule to Control, or set the Schedule to None.</p>	<p>CHECK SCHEDULE MASTER WIRING ON TN4 BUS CHECK SCHEDULE MASTER ADDRESS ON TN4 BUS</p>

WARNING: This product contains chemicals known to the State of California to cause cancer and birth defects or other reproductive harm. For more information: www.watts.com/prop65

Technical Data

Boiler Control 284 <i>Four tN4, BAS, Four Boiler, DHW & Setpoint</i>	
Literature	284_A, 284_B, 284_C, 284_D
Control	Microprocessor control. This is not a safety (limit) control
Packaged weight	5.5 lb. (2490 g)
Dimensions	8-1/16" H x 11-1/8" W x 2-15/16" D (204 x 282 x 74 mm)
Enclosure	Blue PC+ABS plastic with metal top & bottom conduit connection walls, NEMA type 1
Approvals	CSA C US, meets class B: ICES & FCC Part 15, BTL Listed
Ambient conditions	Indoor use only, 32 to 122°F (0 to 50°C), < 90% RH non-condensing
Power supply	115 V (ac) ±10%, 60 Hz, 18 VA
Primary Pump relays	230 V (ac) 10 A, 1/2 hp
Boiler Pump / Valve & IDHW Pump relays	230 V (ac) 5 A, 1/3 hp
Boiler Stage, Auxiliary & Alert relays	230 V (ac) 5 A, 1/6 hp
Modulating outputs	4 x 0-10 V (dc) 500 Ω minimum load impedance / 4-20 mA 1 kΩ max load impedance
Calls	24 V (ac) or Short
Sensors	NTC thermistor, 10 kΩ @ 77°F (25°C ±0.2°C) β=3892
–Included	Outdoor Sensor 070 & 2 of Universal Sensor 082
–Optional	tekmar type: 071, 078, 082
Warranty	Limited 3 Year

Limited Warranty & Product Return Procedure

Limited Warranty *The liability of tekmar under this warranty is limited. The Purchaser, by taking receipt of any tekmar product ("Product"), acknowledges the terms of the Limited Warranty in effect at the time of such Product sale & acknowledges that it has read & understands same.*

The tekmar Limited Warranty to the Purchaser on the Products sold hereunder is a manufacturer's pass-through warranty which the Purchaser is authorized to pass through to its customers. Under the Limited Warranty, each tekmar Product is warranted against defects in workmanship & materials if the Product is installed & used in compliance with tekmar's instructions, ordinary wear & tear excepted. The pass-through warranty period is for a period of twenty-four (24) months from the production date if the Product is not installed during that period, or twelve (12) months from the documented date of installation if installed within twenty-four (24) months from the production date.

The liability of tekmar under the Limited Warranty shall be limited to, at tekmar's sole discretion: the cost of parts & labor provided by tekmar to repair defects in materials &/or workmanship of the defective product; or to the exchange of the defective product for a warranty replacement product; or to the granting of credit limited to the original cost of the defective product, & such repair, exchange or credit shall be the sole remedy available from tekmar, &, without limiting the foregoing in any way, tekmar is not responsible, in contract, tort or strict product liability, for any other losses, costs, expenses, inconveniences, or damages, whether direct, indirect, special, secondary, incidental or consequential, arising from ownership or use of the product, or from defects in workmanship or materials, including any liability for fundamental breach of contract.

The pass-through Limited Warranty applies only to those defective Products returned to tekmar during the warranty period. This Limited Warranty does not cover the cost of the parts or labor to remove or transport the defective Product, or to reinstall the repaired or replacement Product, all such costs & expenses being subject to Purchaser's agreement & warranty with its customers.

Any representations or warranties about the Products made by Purchaser to its customers which are different from or in excess of the tekmar Limited Warranty are the Purchaser's sole responsibility & obligation. Purchaser shall indemnify & hold tekmar harmless from & against any & all claims, liabilities & damages of any kind or nature which arise out of or are related to any such representations or warranties by Purchaser to its customers.

The pass-through Limited Warranty does not apply if the returned Product has been damaged by negligence by persons other than tekmar, accident, fire, Act of God, abuse or misuse; or has been damaged by modifications, alterations or attachments made subsequent to purchase which have not been authorized by tekmar; or if the Product was not installed in compliance with tekmar's instructions &/or the local codes & ordinances; or if due to defective installation of the Product; or if the Product was not used in compliance with tekmar's instructions.

THIS WARRANTY IS IN LIEU OF ALL OTHER WARRANTIES, EXPRESS OR IMPLIED, WHICH THE GOVERNING LAW ALLOWS PARTIES TO CONTRACTUALLY EXCLUDE, INCLUDING, WITHOUT LIMITATION, IMPLIED WARRANTIES OF MERCHANTABILITY & FITNESS FOR A PARTICULAR PURPOSE, DURABILITY OR DESCRIPTION OF THE PRODUCT, ITS NON-INFRINGEMENT OF ANY RELEVANT PATENTS OR TRADEMARKS, & ITS COMPLIANCE WITH OR NON-VIOLATION OF ANY APPLICABLE ENVIRONMENTAL, HEALTH OR SAFETY LEGISLATION; THE TERM OF ANY OTHER WARRANTY NOT HEREBY CONTRACTUALLY EXCLUDED IS LIMITED SUCH THAT IT SHALL NOT EXTEND BEYOND TWENTY-FOUR (24) MONTHS FROM THE PRODUCTION DATE, TO THE EXTENT THAT SUCH LIMITATION IS ALLOWED BY THE GOVERNING LAW.

Product Warranty Return Procedure All Products that are believed to have defects in workmanship or materials must be returned, together with a written description of the defect, to the tekmar Representative assigned to the territory in which such Product is located. If tekmar receives an inquiry from someone other than a tekmar Representative, including an inquiry from Purchaser (if not a tekmar Representative) or Purchaser's customers, regarding a potential warranty claim, tekmar's sole obligation shall be to provide the address & other contact information regarding the appropriate Representative.



tekmar Control Systems Ltd., A Watts Water Technologies Company. Head Office: 5100 Silver Star Road, Vernon, B.C. Canada V1B 3K4, 250-545-7749, Fax. 250-545-0650 Web Site: www.tekmarControls.com

