

Product Catalog

Strainers / Check Valves / Butterfly Valves / Specialty Products



Table of Contents

Special Approvals <i>Fireline, ABS, API and Special Specifications.....</i>	4
Special Approvals <i>Military Specifications.....</i>	3
Templates for Drilling <i>150 lb., 300 lb. and 600 lb. steel standards.....</i>	4
Flange Bolting Data <i>For Butterfly Valves.....</i>	5
“Y” Type Strainers <i>Cast Iron, Bronze, Cast Steel, Stainless Steel.....</i>	6
Basket Type Strainers <i>Cast Iron, Bronze, Cast Steel, Stainless Steel.....</i>	9
Duplex Strainers <i>REVOLUTIONARY BALL - PLEX™.....</i>	10
Special Strainers <i>Cast Iron, Bronze.....</i>	12
Fabricated Strainers <i>Quick Acting Line Blinds.....</i>	13
Pump Protection <i>Control-Chek®, Suction Diffuser.....</i>	15
Chexter Check Valves	16
Silent Check Valves <i>Compact Wafer & Wafer Globe Type.....</i>	19
Sure Check® Valves <i>Double Disc Check Valves.....</i>	23
Butterfly Valves <i>Wafer Style, Full & Semi Lug Style.....</i>	25
Loxend® <i>Grooved End Products.....</i>	27

About Mueller Steam Specialty

Beginning in New York City as a small specialty manufacturer servicing the valve industry, Mueller Steam Specialty incorporated in 1956 to start manufacturing pipeline strainers. Since then, the company and its product offering have expanded dramatically. The company moved to North Carolina in 1972 and due to its continued growth, moved again in 1992 to a new and larger facility in St. Pauls, North Carolina. There are now over 300,000 square feet of ISO 9001:2000 registered manufacturing space devoted to Mueller's various product lines. In addition to a full range of pipeline and specialty strainers, the company now manufactures a broad offering of check valves and butterfly valves.

Mueller Joins the Watts Family

In December 2005, Mueller became a part of the Watts Water Technologies, Inc. family of companies. The resources and support that Watts has added to Mueller have enabled the company to consolidate previous efforts while at the same time plan for future growth and expansion in products and services.

Mueller Today

Today, Mueller Steam Specialty is the world's largest supplier of strainers and the number one provider of specialty products serving the valve industry. While the company has seen many changes, the dedication to quality, service and delivery remains the same. As always, Mueller Steam Specialty brand strainers and valves will continue to be the premier products of their kind in the marketplace.

Trademarks:

- Viton® is a trademark of DuPont Performance Elastomers, L.L.C.
- Teflon® is a trademark of E. I du Pont de Nemours and Company Corporation
- Rilsan® is a trademark of Arkema Corporation
- Monel® is a trademark of Inco Alloys International, Inc.
- Inconel® is a trademark of Inco Alloys International, Inc.
- Stellite® is a trademark of Deloro Stellite Holdings Corporation
- Kynar® is a trademark of - Arkema, Inc.
- Halar® is a trademark of - Ausimont USA, Inc.
- Hypalon® is a trademark of - Dupont Performance Elastomers L.L.C.

How To Order

- 11 Duplex Strainers
- 17 Chexter® Check Valve
- 22 Silent Check Valves
- 24 Sure Check® Valves
- 26 Butterfly Valves
- 28 LOCKEND®

Ordering Information

Important: To assist you in ordering the proper product for your application, the following information is necessary: operating pressure, temperature, flow rates and/or velocity and the type of service used.

Specials Approvals - Fireline, ABS, Special Specifications, and API

Strainers

Approval Type	Model	Size		Description
		<i>in.</i>	<i>mm</i>	
FM	595	4, 6, 8	100, 150, 200	Cast Iron Body, Class 125, basket strainer, flanged ends
UL	595	4, 5, 6, 8, 10, 12	100, 125, 150, 200, 250, 300	Cast Iron Body, Class 125, basket strainer, flanged ends
UL	911U	2 1/2, 3, 4, 5, 6, 8, 10, 12	65, 80, 100, 125, 150, 200, 250, 300	Cast Iron Body, Class 125, "Y" strainer, flanged ends
UL	911U	2 1/2, 3, 4, 5, 6, 8, 10, 12	65, 80, 100, 125, 150, 200, 250, 300	Cast Steel Body, Class 150, "Y" strainer, flanged ends

Sure Check™ Valves

Approval Type	Model	Size		Description
		<i>in.</i>	<i>mm</i>	
FM	71	2, 2 1/2, 3, 4, 5, 6, 8, 10, 12, 14, 16	50, 65, 80, 100, 125, 150, 200, 250, 300, 350, 400	Cast Iron Body, Class 125, wafer type double disc check valve
FM	72	2, 2 1/2, 3, 4, 5, 6, 8, 10, 12, 14	50, 65, 80, 100, 125, 150, 200, 250, 300, 350	Bronze, Carbon or Stainless Steel, Class 150, 200, 250, 300, 350 wafer type double disc check valve
FM	74	2, 2 1/2, 3, 4, 5, 6, 8, 10, 12, 14	50, 65, 80, 100, 125, 150, 200, 250, 300, 350	Bronze, Carbon or Stainless Steel, Class 300, wafer type double disc check valve
UL	71U	4, 6, 8, 10, 12	100, 150, 200, 250, 300	Cast Iron Body, Class 125, wafer type double disc check valve

ABS Type Approved Strainers

Includes all Mueller Steam Specialty "Y" strainers, basket strainers, duplex strainers, check valves & rubber seated butterfly valves. See ABS web site for detail: www.eagle.org/typeapproval/contents.HTML

Special Specifications

ASTM F1199 Cast and Welded Pipeline Strainers - "Y and basket strainers

ASTM F1200 Fabricated Strainers

API

- Mueller Steam Specialty Sure Check Valves conform to API 598 & 6D.
- Mueller Steam Specialty rubber seated butterfly valves conform to API 609 and MSS SP 67.
- All Mueller Steam Specialty standard butterfly valves conform to MSS SP 25 and MSS SP 55.

PED

- Mueller Steam Specialty has PED (Pressure Equipment Directive) approval for pipeline strainers and check valves.

Products	Size	Class
Y Strainers	1 1/2" - 24"	ANSI 125 to 2500
Basket Strainers	1 1/2" - 24"	ANSI 125 - 600
Pipe Line Check Valves	1 1/4" - 54"	ANSI 125 to 2500

All Strainers, Check Valves and Butterfly Valves can be modified to meet many customers special specifications or requirements. Consult factory for more information.

Specials Approvals - Military Specification

“Y” Strainers

Specification	Model	Description
Mil-S-002953C: Class A, B, D	582, 764/WE, 766M/WE, 862/BC, 864M	“Y” type, 3" & below, 600# & 1500# flanged, socket weld, or butt weld end connection, bolted cover
WW-S-2739: Type 1	11M	“Y” type, iron body, screwed, brass blow off plug
WW-S-2739: Type 2	758	“Y” type, iron body, flanged, brass blow off plug
Mil-S-21427A	764/WE, 766M/WE	“Y” type main steam line, drilled screen, X-Ray, magnaflux, 4" & above, 600# & 1500# flanged, socket weld, or butt weld end connection
Mil-B-24480	851M, 852	“Y” type, bronze or nickel aluminum bronze body material, flanged end 150# & 300# sea water strainer
#810-8441499 Rev J (NAVSHIPS)	352 1/2	“Y” type, bronze body, Silver brazing ends

Basket Strainers

Specification	Model	Description
Mil-S-13789A	125F* Grooved nipples often required. The specification also describes 250#	Basket strainer, iron body, flanged, large capacity, surge test, flanged to grooved nipples often required, 150#, 300# and 600# steel
Mil-B-24480	165, 125, 125F	Basket strainer, bronze or nickel aluminum bronze body, screwed or flanged ends, Class 125-300, sea water strainer

Duplex Strainers

Specification	Model	Description
Mil-S-17849E	690/790 Series	Pipe Line Duplex Strainers, all models can meet this specification

Silent Check Valves

Specification	Model	Description
Mil-V-18436E	See Description	All Mueller Steam Specialty Silent Check Valves - consult factory

* All Strainers, Check Valves and Butterfly Valves can be modified to meet many customers special specifications or requirements. Consult factory for more information.

Templates for Drilling - Fire Line, ABS, Special Specifications, and API

150, 300 & 600 Pound Steel Standards

Class	Size		A	B	C	D	E	# of Bolts or Studs	Dia. of Bolts or Studs	F	G
	in.	mm									
	1/2	15	1/2	3 1/2	7/16	1 3/8	2 3/8	4	1/2	2 1/4	1 3/4
	3/4	20	3/4	3 7/8	7/16	1 11/16	2 3/4	4	1/2	2 1/4	2
	1	25	1	4 1/4	7/16	2	3 1/8	4	1/2	2 1/2	2
	1 1/4	32	1 1/4	4 5/8	1/2	2 1/2	3 1/2	4	1/2	2 1/2	2 1/4
	1 1/2	40	1 1/2	5	9/16	2 7/8	3 7/8	4	1/2	2 1/2	2 1/4
	2	50	2	6	5/8	3 5/8	4 3/4	4	5/8	3 1/4	2 1/2
	2 1/2	65	2 1/2	7	11/16	4 1/8	5 1/2	4	5/8	3 1/2	2 3/4
	3	80	3	7 1/2	3/4	5	6	4	5/8	3 1/2	3
150 Lb.	3 1/2	95	3 1/2	8 1/2	13-16	5 1/2	7	8	5/8	1/2	3
	4	100	4	9	15/16	6 3/16	7 1/2	8	5/8	3 1/2	3
	5	125	5	10	15/16	7 5/16	8 1/2	8	3/4	3 3/4	3
	6	150	6	11	1	8 1/2	9 1/2	8	3/4	4	3 1/4
	8	200	8	13 1/2	1 1/8	10 5/8	11 3/4	8	3/4	4 1/4	3 1/2
	10	250	10	16	1 3/16	12 3/4	14 1/4	12	7/8	4 3/4	3 3/4
	12	300	12	19	1 1/4	15	17	12	7/8	4 3/4	3 3/4
	14	350	13 1/4	21	1 3/8	16 1/4	18 3/4	12	1	5 1/4	4 1/4
	16	400	15 1/4	23 1/2	1 7/16	18 1/2	21 1/4	16	1	5 1/2	4 1/2
	18	450	17 1/4	25	1 9/16	21	22 3/4	16	1 1/8	6	4 3/4
	20	500	19 1/4	27 1/2	1 11/16	23	25	20	1 1/8	6 1/4	5
	24	600	23 1/4	32	1 7/8	27 1/4	29 1/2	20	1 1/8	7	5 1/2
300 Lb.	1/2	15	1/2	3 3/4	9-16	1 3/8	2 5/8	4	1/2	2 1/2	2
	3/4	20	3/4	4 5/8	5/8	1 11/16	3 1/4	4	5/8	3	2 1/4
	1	25	1	4 7/8	11/16	2	3 1/2	4	5/8	3	2 1/2
	1 1/4	32	1 1/4	5 1/4	3/4	2 1/2	3 7/8	4	5/8	3 1/4	2 1/2
	1 1/2	40	1 1/2	6 1/8	13/16	2 7/8	4 1/2	4	3/4	3 1/2	2 3/4
	2	50	2	6 1/2	7/8	3 5/8	5	8	5/8	3 1/2	2 3/4
	2 1/2	65	2 1/2	7 1/2	1	4 1/8	5 7/8	8	3/4	4	3 1/4
	3	80	3	8 1/4	1 1/8	5	6 5/8	8	3/4	4 1/4	3 1/2
	3 1/2	95	3 1/2	9	1 3/16	5 1/2	7 1/4	8	3/4	1 1/4	3 1/2
	4	100	4	10	1 1/4	6 3/16	7 7/8	8	3/4	4 1/2	3 3/4
5	125	5	11	1 3/8	7 5/16	9 1/4	8	3/4	4 3/4	4	
6	150	6	12 1/2	1 7/16	8 1/2	10 5/8	12	3/4	4 3/4	4	
8	200	8	15	1 5/8	10 5/8	13	12	7/8	5 1/2	4 1/2	
10	250	10	17 1/2	1 7/8	12 3/4	15 1/4	16	1	6 1/4	5 1/4	
12	300	12	20 1/2	2	15	17 3/4	16	1 1/8	6 3/4	5 1/2	
14	350	13 1/4	23	2 1/8	16 1/4	20 1/4	20	1 1/8	7	6	
16	400	15 1/4	25 1/2	2 1/4	18 1/2	22 1/2	20	1 1/4	7 1/2	6 1/4	
18	450	17	28	2 3/8	21	24 3/4	24	1 1/4	7 3/4	6 1/2	
20	500	19	30 1/2	2 1/2	23	27	24	1 1/4	8 1/4	6 3/4	
24	600	23	36	2 3/4	27 1/4	32	24	1 1/2	9 1/4	7 3/4	

Facing

Unless otherwise ordered, 150 and 300 Pound Steel Flanged Strainers are regularly furnished with a 1/16" high raised face.

The thickness of flange dimension (dimension "C") includes the 1/16" high raised face.

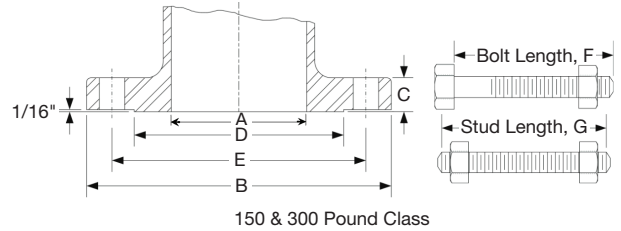

150 and 300 Pound Class

F = Length of stud
G = Length of machine bolt

Bolt Holes

Bolt holes are drilled 1/8" larger than the diameter of the bolt.

Drilling templates are in multiples of four, so that valves or fittings may be turned to face in any quarter when installed. Bolt holes are drilled to straddle the center-line unless otherwise ordered.

The bolt holes are spot faced.

Bolt & Stud Lengths

The lengths indicated as dimensions F and G in the above table apply for flanged joints made up of combinations of 150lb or 300lb valves, fittings, or companion flanges with 1/16" high raised faces.

Stud Length "G" also applies for Tongue to Groove Flanged Joint.

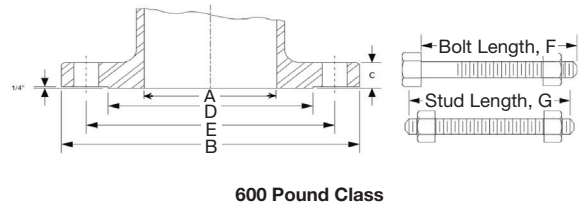

600 Pound Class

F = Length of stud
G = Length of machine bolt

Templates for Drilling - Fire Line, ABS, Special Specifications, and API

150, 300 & 600 Pound Steel Standards

Class	Size		A	B	C	D	E	# of Bolts or Studs	Dia. of Bolts or Studs	F	G
	in.	mm									
	1/2	15	1/2	3 3/4	9/16	1 3/8	2 5/8	4	1/2	3	2 3/4
	3/4	20	3/4	4 5/8	5/8	1 11/16	3 1/4	4	5/8	3 1/2	3 1/4
	1	25	1	4 7/8	11/16	2	3 1/2	4	5/8	3 1/2	3 1/4
	1 1/4	32	1 1/4	5 1/4	13/16	2 1/2	3 7/8	4	5/8	3 3/4	3 1/2
	1 1/2	40	1 1/2	6 1/8	7/8	2 7/8	4 1/2	4	3/4	4 1/4	4
	2	50	2	6 1/2	1	3 5/8	5	8	5/8	4 1/4	4
	2 1/2	65	2 1/2	7 1/2	1 1/8	4 1/8	5 7/8	8	3/4	4 3/4	4 1/2
	3	80	3	8 1/4	1 1/4	5	6 5/8	8	3/4	5	4 3/4
600 Lb.	3 1/2	95	3 1/2	9	1 3/8	5 1/2	7 1/4	8	7/8	5 3/4	5 1/2
	4	100	4	10 3/4	1 1/2	6 3/16	8 1/2	8	7/8	5 3/4	5 1/2
	5	125	5	13	1 3/4	7 5/16	10 1/2	8	1	6 1/2	6 1/4
	6	150	6	14	1 7/8	8 1/2	11 1/2	12	1	6 3/4	6 1/2
	8	200	7 7/8	16 1/2	2 3/16	10 5/8	13 3/4	12	1 1/8	7 3/4	7 1/2
	10	250	9 3/4	20	2 1/2	12 3/4	17	16	1 1/4	8 1/2	8 1/4
	12	300	11 3/4	22	2 5/8	15	19 1/4	20	1 1/4	8 3/4	8 1/2
	14	350	12 7/8	23 3/4	2 3/4	16 1/4	20 3/4	20	1 3/8	9 1/4	9
	16	400	14 3/4	27	3	18 1/2	23 3/4	20	1 1/2	10	9 3/4
	18	450	16 1/2	29 1/4	3 1/4	21	25 3/4	20	1 5/8	10 3/4	10 1/2
	20	500	18 1/4	32	3 1/2	23	28 1/2	24	1 5/8	11 1/2	11 1/4
	24	600	22	37	4	27 1/4	33	24	1 7/8	13	12 3/4

Dimensions in inches except where noted.
400 lb., 900 lb., 1500 lb. and 2500 lb. measurements on application.

Butterfly Valve Flange Bolting Data

Full Lug: 88

BFV Size	Item	Size	Length	Qty
2	Cap Screw	5/8 - 11 UNC	1 1/4	8
2 1/2 & 3	Cap Screw	5/8 - 11 UNC	1 1/2	8
4	Cap Screw	5/8 - 11 UNC	1 1/2	16
5	Cap Screw	3/4 - 10 UNC	1 3/4	16
6	Cap Screw	3/4 - 10 UNC	2	16
8	Cap Screw	3/4 - 10 UNC	2 1/4	16
10	Cap Screw	7/8 - 9 UNC	2 1/2	24
12	Cap Screw	7/8 - 9 UNC	2 1/2	24
14	Cap Screw	1 - 8 UNC	3	24
16	Cap Screw	1 - 8 UNC	3	32
18	Cap Screw	1 1/8 - 7 UNC	3 1/2	32
20	Cap Screw	1 1/8 - 7 UNC	3 1/2	40
24	Cap Screw	1 1/4 - 7 UNC	3 3/4	40

Facing

600-Pound Steel Strainers are regularly furnished with 1/4" high large male face. The thickness of flange dimension (dimension "C") does not include the 1/4" high large male face.

Spot Facing

The bolt holes are spot faced.

Bolt Holes

Bolt holes are drilled 1/8" larger than the diameter of the bolt.

THREADED LUG

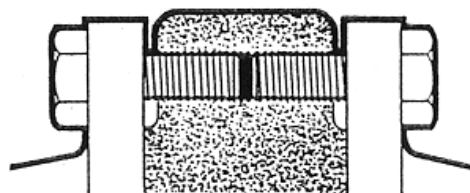

“Y” Type Strainers

Lead Free*

Mueller Steam Specialty supplies customers world-wide with all of their requirements for "Y" Strainers. Whether the need is for a simple low pressure cast iron threaded strainer or a large, high pressure special alloy unit with a custom cap design, we have the "Y" strainers that fit the application.

We maintain a large stock of both standard and special sizes and materials. This stock includes end connections of threaded, flanged, socket weld, butt weld, solder, silbrazed and grooved ends. We also have units with screwed caps, bolted caps, hinge type covers and swing type clamp covers.

Pressure is not a problem for Mueller Steam Specialty. "Y" strainers are available for pressures from ANSI Class 125 through Class 2500 and higher.

All of these strainers are available in a wide variety of materials. Units are maintained in stock with standard materials such as:

- Cast Iron
- 316 SS
- Monel
- Bronze
- 304 SS
- Ductile Iron
- 316L SS
- Hastelloy
- Carbon Steel
- Alloy 20

Model 11M

Class 250

Cast Iron - NPT Ends, Screwed Cap

- Size: ¼" - 4" (8 - 100mm)
- 250psi WSP @ 400°F
- 17 bar @ 204°C
- 400psi WOG @ 150°F
- 27 bar @ 65°C



Model LF351M

Class 125

Bronze - NPT, Screwed

- Size: ¼" - 3" (8 - 80mm)
- 150psi WSP @ 350°F
- 10 bar @ 176°C
- 200psi WOG @ 150°F
- 13 bar @ 65°C



Model LF352M

Class 250

Bronze - NPT, Screwed Cap

- Size: ¼" - 4" (8 - 100mm)
- 300psi WSP @ 350°F
- 20 bar @ 176°C
- 400psi WOG @ 150°F
- 27 bar @ 65°C

Model 352 ½

Class 250

Bronze - Silbrazed Ends, Screwed Cap

- Size: ¼" - 4" (8 - 100mm)
- 250psi WSP @ 425°F
- 17 bar @ 218°C



Model 353 ½

Class 125

Bronze - Solder Ends, Gasket Cover

- Size: ¼" - 4" (8 - 100mm)
- 175psi WOG @ 250°F
- 12 bar @ 121°C

Model LF358S

Class 125

Bronze - Solder Ends, Screwed Cap

- Size: ¼" - 3" (8 - 80mm)
- 175psi WOG @ 250°F
- 12 bar @ 121°C

Model 758

Class 125

Cast Iron - Flanged Ends, Bolted Flange Cover

- Size: ¾" - 24" (20 - 600mm) to 12" (to 300mm)
- 125psi WSP @ 450°F
- 8 bar @ 232°C
- 200psi WOG @ 150°F
- 13 bar @ 65°C
- 100psi WSP @ 353°F
- 7 bar @ 178°C
- 150psi @ WOG @ 150°F
- 10 bar @ 65°C



Model 752

Class 250

Cast Iron - Flanged Ends, Bolted Flanged Cover

- Size: ½" - 24" (15 - 600mm) to 12" (to 300mm)
- 250psi WSP @ 450°F
- 17 bar @ 232°C
- 500psi WOG @ 150°F
- 34 bar @ 65°C
- 200psi WSP @ 406°
- 13 bar @ 208°C
- 300psi WOG @ 150°F
- 20 bar @ 65°C

Our Screens & Baskets are Designed to Achieve Maximum Straining Efficiency

The most critical aspect to any strainer is straining efficiency and durability. Mueller Steam Specialty's many years of experience and continuous improvements provide the highest quality. We carry a larger inventory of perforated metals and meshes than any other strainer manufacturer in the world. Besides standard metals, we carry thousands of variations of materials and openings. Openings range from 1" to 5 microns.

Note: Retainer caps/covers shown are for illustration purposes only. They do not necessarily reflect actual product shipped.

"Y" Type Strainers

Lead Free*

Model 781 Model 781-SS*



Class 150

Cast Steel/Stainless Steel - Flanged Ends, Bolted Flange Cover

- Size: ½" - 24" (15 - 600mm)
- 150psi WSP @ 565°F
- 10 bar @ 296°C
- 285psi WOG @ 100°F
- 19 bar @ 38°C

Model 782 Model 782-SS*

Class 300

Cast Steel/Stainless Steel - Flanged Ends, Bolted Flange Cover

- Size: ½" - 20" (15 - 500mm)
- 300psi WSP @ 838°F
- 20 bar @ 448°C
- 740psi WOG @ 100°F
- 51 bar @ 38°C

Model 764/764-SS*

Class 600

Cast Steel/Stainless Steel - Flanged Ends, Bolted Flange Cover

- Size: ½" - 20" (15 - 500mm)
- 600psi WSP @ 838°F
- 41 bar @ 448°C
- 1480psi WOG @ 100°F
- 102 bar @ 38°C

Model 781-WE Model 781-SS-WE*



Class 150

Cast Steel/Stainless Steel Butt weld Ends, Bolted Flange Cover

- Size: ½" - 24" (15 - 600mm)
- 150psi WSP @ 565°F
- 10 bar @ 296°C
- 285psi WOG @ 100°F
- 19 bar @ 38°C

Model 782-WE Model 782-SS-WE*

Class 300

Cast Steel/Stainless Steel Butt Weld Ends, Bolted Flange Cover

- Size: ½" - 24" (15 - 600mm)
- 300psi WSP @ 838°F
- 20 bar @ 448°C
- 740psi WOG @ 100°F
- 51 bar @ 38°C

Model 764-WE Model 764-SS-WE*

Class 600

Cast Steel/Stainless Steel Butt Weld Ends, Bolted Flange Cover

- Size: ½" - 16" (15 - 400mm)
- 600psi WSP @ 838°F
- 41 bar @ 448°C
- 1480psi WOG @ 100°F
- 102 bar @ 38°C

Model 765M Model 765M-SS*



Class 900

Cast Steel/Stainless Steel - Flanged Ends, Bolted Flange Cover

- Size: ½" - 10" (15 - 250mm)
- 900psi WSP @ 838°F
- 62 bar @ 448°C*
- 2200psi WOG @ 100°F
- 151 bar @ 38°C

Model 766M Model 766M-SS*

Class 1500

Cast Steel/Stainless Steel - Flanged Ends, Bolted Flange Cover

- Size: ½" - 12" (15 - 300mm)
- 1500psi WSP @ 838°F
- 103 bar @ 448°C
- 3705psi WOG @ 100°F
- 255 bar @ 38°C

Model 767 Model 767-SS*

Class 2500

Cast Steel/Stainless Steel - Flanged Ends, Bolted Flange Cover

- Size: ½" - 12" (15 - 300mm)
- 2500psi WSP @ 838°F
- 172 bar @ 448°C
- 6170psi WOG @ 100°F
- 425 bar @ 38°C

Model 851M

Class 150

Bronze - Flanged Ends, Bolted Flange Cover

- Size: ½" - 12" (15 - 300mm)
- 150psi WSP @ 406°F
- 10 bar @ 208°C
- 225psi WOG @ 150°F
- 15 bar @ 65°C

Model 852

Class 300

Bronze - Flanged Ends, Bolted Flange Cover

- Size: ½" - 12" (15 - 300mm)
- 350psi WSP @ 350°F
- 24 bar @ 176°C
- 500psi WOG @ 150°F
- 34 bar @ 65°C

* Pressure-Temperature Rating for Stainless Steel Models only

Consult factory for Carbon Steel. Optional sizes, materials, baskets, gaskets and mesh liners are available on application.

Mueller Steam Specialty "Y" strainers have generously proportioned bodies with screens that have an open area many times greater than the corresponding pipe size to ensure low pressure loss. All strainers are hydrostatically tested in accordance with applicable ANSI, API and MSS standards.

“Y” Type Strainers

Lead Free*

Model 765M-WE Model 765M-SS-WE*

Class 900

Cast Steel/Stainless Steel - Butt Weld Ends, Bolted Flange Cover

- Size: ½" - 14" (15 - 350mm)
- 900psi WSP @ 838°F
- 62 bar @ 448°C*
- 2200psi WOG @ 100°F
- 153 bar @ 38°C



Model 766M-WE Model 766M-SS-WE*

Class 1500

Cast Steel/Stainless Steel - Butt Weld Ends, Bolted Flange Cover

- Size: ½" - 16" (15 - 400mm)
- 1500psi WSP @ 838°F
- 103 bar @ 448°C
- 3705psi WOG @ 100°F
- 255 bar @ 38°C

Model 767-WE Model 767-SS-WE*

Class 2500

Cast Steel/Stainless Steel - Butt Weld Ends, Bolted Flange Cover

- Size: ½" - 16" (15 - 400mm)
- 2500psi WSP @ 838°F
- 172 bar @ 448°C
- 6170psi WOG @ 100°F
- 425 bar @ 38°C

Model 861-BC Model 861-SS-BC*

Class 600

Cast Steel/Stainless Steel, NPT Ends, Bolted Flange Cover

- Size: ¼" - 2" (8 - 50mm)

Model 862-BC Model 862-SS-BC*

Cast Steel/Stainless Steel, Socket Weld Ends, Bolted Flange Cover

- Size: ½" - 3" (15 - 80mm)
- 600psi WSP @ 838°F
- 41 bar @ 448°C
- 1480psi WOG @ 100°F
- 102 bar @ 38°C

Model 581/581-SS* Model 861/861-SS*

Class 600

Cast Steel/Stainless Steel, NPT Ends & Cap

- Size: ½" - 2" (15 - 50mm)

Model 582/582-SS* Model 862/862-SS*

Class 600

Cast Steel/Stainless Steel, NPT Ends & Screwed Cap

- Size: ¼" - 2" (8 - 50mm)
- 600psi WSP @ 838°F
- 41 bar @ 448°C
- 1480psi WOG @ 100°F
- 102 bar @ 38°C



Model 863M Model 863M-SS*

Class 1500

Cast Steel/Stainless Steel, NPT Ends, Screwed Cap

- Size: ½" - 2" (15 - 50mm)
- 1 ¼", 1 ½", & 2" (32, 40, 50mm) have Bolted Cap



Model 864M Model 864M-SS*

Class 1500

Cast Steel/Stainless Steel Socket Weld End, Screwed Caps

- Size: 1 ¼" - 2" (32 - 50mm)
- 1 ¼", 1 ½" & 2" (32, 40, 50mm) have Bolted Cap
- 1500psi WSP @ 838°F
- 103 bar @ 448°C
- 3705psi WOG @ 100°F
- 255 bar @ 38°C

Model 865 Model 865-SS*

Class 2500

Cast Steel/Stainless Steel, NPT Ends, Bolted Flange Cover

- Size: ½" - 2" (15 - 50mm)



Model 866 Model 866-SS*

Class 1500

Cast Stainless Steel, Socket Weld Ends, Bolted Flange Cover

- Size: ½" - 2" (15 - 50mm)
- 2500psi WSP @ 838°F
- 172 bar @ 448°C
- 6170psi WOG @ 100°F
- 425 bar @ 38°C

* Pressure-Temperature Rating for Stainless Steel Models only

Consult factory for Carbon Steel. Optional sizes, materials, baskets, gaskets and mesh liners are available on application.

Mueller Steam Specialty "Y" strainers have generously proportioned bodies with screens that have an open area many times greater than the corresponding pipe size to insure low pressure loss. All strainers are hydrostatically tested in accordance with applicable ANSI, API and MSS standards.

Basket Type Strainers

Lead Free*

Mueller Steam Specialty Simplex Basket Strainers are called for when the application requires a strainer with an extremely large capacity. Most of these strainers have an open area ratio of 6 to 1 with even greater open area ratios available.

As with all of the Mueller Steam Specialty strainers, basket strainers are available in an almost endless combination of materials, pressures, end connections and cover configurations from 1/4" to 24" (72" in fabricated units). Units are also available in cast iron, bronze, carbon steel, stainless steel, Alloy 20 and most other alloys. The baskets in the Mueller Steam Specialty simplex basket strainers share the same quality of construction as the Mueller Steam "Y" strainers.

From threaded end connections to offset flanged connections, we can provide the exact basket strainer to meet your needs.

Model 125/125-B**

Model 125-CS/125-SS**

Class 125 - 250*

Cast Iron, Bronze, Cast Steel, Stainless Steel NPT Ends, Quick Open Cover with Non-Yoke Knobs, O-ring Seal, & Bolted Cover

- Size: 3/8" - 3" (10 - 80mm)
- 200psi WOG @ 150°F
- 13 bar @ 65°C*



Model 125F/125F-B**

Model 125F-CS/125F-SS**

Class 125 - 250*

Cast Iron, Bronze, Cast Steel, Stainless Steel Flanged Ends, Quick Open Cover with Non-Yoke Knobs on most sizes, O-Ring Seal

- Size 1" - 12" (25 - 300mm)
- 200psi WOG @ 150°F
- 13 bar @ 65°C
- 125psi WSP @ 350°F
- 9 bar @ 177°C



Model 155M

Class 125

Cast Iron Flanged Ends, Side Swing Clamps on 2" - 12", Vertical Swing Clamps on 14" and 16", Bolted Cover

- Size: 2" - 16" (50 - 400mm) to 12" 200psi WOG @ 150°F (to 300mm) 13 bar @ 65°C
- 14" - 16" 150psi WOG @ 150°F (350 - 400mm) 10 bar @ 65°C

* with bolted cover



Model 165

Class 125

Cast Iron Flanged Ends, Flange Cover

- Size: 1 1/4" - 24" (32 - 600mm) to 12" For Steam Consult Factory 200psi WOG @ 150°F 13 bar @ 65°C
- 14" - 24" (350 - 600mm) For Steam Consult Factory 150psi WOG @ 150°F 10 bar @ 65°C



Model 166

Class 250

Cast Iron Flanged Ends, Bolted Flange Cover

- Size 2" - 24" (50 - 600mm) to 12" 250psi WSP @ 406°F (to 300mm) 17 bar @ 208°C 500psi WOG @ 150°F 34 bar @ 65°C
- 14" - 24" (350 - 600MM) 200psi WSP @ 406°F 13 bar @ 208°C 300psi WOG @ 150°F 20 bar @ 65°C

Model 165-B

Class 150

Bronze Flanged Ends, Bolted Flange Cover

- Size: 2" - 12" (50 - 300mm)
- 150psi WSP @ 406°F
- 10 bar @ 208°C
- 225psi WOG @ 150°F 15 bar @ 65°C



Model 166-B

Class 300

Bronze Flanged Ends, Bolted Flange Cover

- Size: 2" - 12" (50 - 300mm)
- 350psi WSP @ 406°F
- 24 bar @ 176°C
- 500psi WOG @ 150°F 34 bar @ 65°C
- 300psi WSP @ 406°F
- 20 bar @ 208°C

Model 185/185-SS†

Class 150

Cast Steel/Stainless Steel Flanged Ends, Bolted Flange Cover

- Size: 1 1/4" - 20" (32 - 500mm)
- 150psi WSP @ 565°F
- 10 bar @ 296°C
- 285psi WOG @ 100°F
- 19 bar @ 38°C



Model 186/186-SS†

Class 300

Cast Steel/Stainless Steel Flanged Ends, Bolted Flange Cover

- Size 1 1/4" - 16" (32 - 400mm)
- 505psi WSP @ 750°F
- 20 bar @ 448°C
- 740psi WOG @ 100°F
- 51 bar @ 38°C

Model 126F-CS

Class 300

Cast Steel/Stainless Steel Flanged Ends, Bolted Flange Cover

- Size: 3/4" - 18" (20 - 450mm)
- 300psi WSP @ 838°F
- 21 bar @ 448°C
- 740psi WOG @ 100°F
- 51 bar @ 38°C



Model 126F-SS

Class 300

Cast Steel/Stainless Steel Flanged Ends, Bolted Flange Cover

- Size: 3/4" - 18" (20 - 450mm)
- 300psi WSP @ 838°F
- 21 bar @ 48°C
- 720psi WOG @ 100°F
- 50 bar @ 38°C

**Pressure-Temperature Rating for Cast Iron Models

Consult factory for other materials. Optional sizes, materials, baskets, gaskets and mesh liners are available on application.

† Pressure-Temperature Rating for Stainless Steel Models only

Consult factory for Carbon Steel. Optional sizes, materials, baskets, gaskets and mesh liners are available on application.

Duplex Strainers

Lead Free*

Many times, critical systems cannot be shut down for strainer basket cleaning. These systems include cooling water, compressors, condensers, fire lines, fuel lines, chemical process systems, pump suction applications and other similar services. For these applications, the Mueller Steam Specialty Duplex Strainer is the perfect choice.

For sizes ¾" through 6", the Revolutionary Ball-Plex™ duplex strainer from Mueller Steam Specialty has all of the features you need. Bubble tight seating, true in-line maintainability, extremely easy seat replacement and long, trouble-free service life in a very simple and rugged design.

Available from stock in cast iron, bronze, carbon steel and stainless steel. Other alloys are also available.

All of the Ball-Plex™ units are standard with 316 SS balls and PTFE seats. Other alloys are also available for the balls.

Threaded and flanged units are available with full rated pressures from Class 125 to Class 300 (Class 600 flanges also available). With the floating ball design and relatively low torque requirements, it is very easy to automate these units for remote operation.

MUELLER STEAM SPECIALTY'S REVOLUTIONARY BALL-PLEX™ STRAINER



¾" - 6" (20 - 150mm)

Model 791-SAH



Class 125

Cast Iron NPT Ends, Knob Type Cover
316 SS Balls

- Size: ¾" - 3" (20 - 80mm)
- 200psi WOG @ 150°F
- 13 bar @ 65°C

Model 792-SBH



Class 150

- Bronze
- Size ¾" - 3" (20 - 80mm)

Model 792-SDH*

Class 150

- Carbon Steel
- Size: ¾" - 3" (20 - 80mm)
- 285psi WOG @ 100°F
- 19 bar @ 38°C

Model 792-SHH



Class 150

- Stainless Steel
- Size: ¾" - 3" (20 - 80mm)

Model 791-FAH

Class 150

Cast Iron Flanged Ends, Knob Type
Cover 316 SS Balls

- Size: 1" - 6" (25 - 150mm)
- 200 psi WOG @ 150°F
- 13 bar @ 65°C

Model 794-SBH

Class 300

- Bronze
- Size: ¾" - 3" (20 - 80mm)

Model 794-SDH*

Class 300

- Carbon Steel
- Size ¾" - 3" (20 - 80mm)
- 740psi WOG @ 100°F
- 51 bar @ 38°C



Model 794-SHH

Class 300

- Stainless Steel
- Size: ¾" - 3" (20 - 80mm)

Model 796-SDH*

Class 600

- Carbon Steel
- Size: ¾" - 3" (20 - 80mm)
- 740psi WOG @ 100°F
- 51 bar @ 38°C

Model 796-SHH

Class 600

- Stainless Steel
- Size: ¾" - 3" (20 - 80mm)



Model 792-FBH

Class 150

- Bronze
- Size: 1" - 6" (25 - 150mm)

Model 792-FDH*

Class 150

- Carbon Steel
- Size: 1" - 6" (25 - 150mm)
- 285psi WOG @ 100°F
- 19 bar @ 38°C

Model 792-FHH

Class 150

- Stainless Steel
- Size: 1" - 6" (25 - 150mm)

Model 794-FBH

Class 300

- Bronze
- Size: 1" - 6" (25 - 150mm)

Model 794-FDH*

Class 300

- Carbon Steel
- Size 1" - 6" (25 - 150mm)
- 740psi WOG @ 100°F
- 51 bar @ 38°C



Model 794-FHH

Class 300

- Stainless Steel
- Size: 1" - 6" (25 - 150mm)



Model 796-FDH*

Class 600

- Carbon Steel
- Size: 1" - 6" (25 - 150mm)
- 740psi WOG @ 100°F
- 51 bar @ 38°C

Model 796-FHH*

Class 600

- Stainless Steel
- Size: 1" - 6" (25 - 150mm)

* Pressure-Temperature Rating for Stainless Steel Models only

Consult factory for Carbon Steel. Optional sizes, materials, baskets, gaskets and mesh liners are available on application.

Duplex Strainers - 8" - 24"

Lead Free*

For sizes from 8" - 24" (200 - 600mm), the larger Mueller Steam Specialty duplex strainer is the unit of choice. Using an in-line plug design, quick flow transfer is accomplished with less than a 90° rotation of the handle. Economical actuation of the unit is also available.

Sizes 8" - 16" (200 - 400mm) are available in cast iron, bronze, carbon steel and stainless steel and Class 125 and 150.

Sizes 18" - 24" (450 - 600mm) are fabricated. All units can be supplied with special materials, baskets and coatings.

8" - 24" Duplex Strainers

Model 691 MFA

Class 125

Body: Cast Iron Flanged Ends, Bolted or Clamped Flange Cover

- Size: 8" - 16" (200 - 400mm)
- 150psi @ 150°F
- 10 bar @ 65°C

Model 692 MF

Class 150

Body: Bronze, Carbon Steel, Stainless Steel Flanged Ends, Bolted or Clamped Flange Cover

Clamp Cover

- Size: 8" - 16" (200 - 400mm)
- 150psi WOG @ 100°F
- 10 bar @ 38°C

Bolted Cover

- Size: 8" - 16"(200 - 400mm)
- 200psi WOG @ 100°F
- 13 bar @ 38°C
- Size: 14" - 16" (350 - 400mm)
- 150 psi WOG @ 100°F
- 10 bar @ 38°C

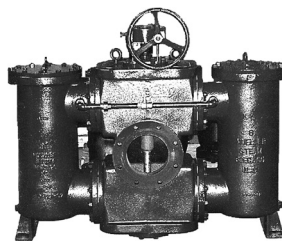

How to Order

Mueller Steam Specialty **Ball Plex™** Duplex Strainer basic model numbers are based on ANSI Class connections as follows:

- 791 for Class 125
- 792 for Class 150
- 794 for Class 300
- 796 for Class 600

For Marine and other larger styles:
690 for 50psi (marine duplex with Class 125 flanges)

- 691 for Class 125
- 692 for Class 150

Example

Three inch Model 791S-AH (see above) with some special feature such as special baskets, blow-off connections, special O-rings, etc.

This is a Class 125 duplex strainer with NPT Ends, cast iron body and covers, stainless steel balls. The ordering and tagging number is written as follows:

Model #	Code	Example	3.0	791	S	A	H	X
Pipe Size								
Model No								
End								
Body								
Ball								
Special Feature								

Consult factory for all special features. If no special features are required use "O" in place of "X" in the ordering and tagging number.

	Material	Code
End	Flanged	F
	NPT	S
Body	Cast Iron	A
	Bronze	B
	Carbon Steel	D
	Stainless Steel	H
Ball	Monel	Q
	Bronze	B
	Stainless Steel	H

* Pressure-Temperature Rating for Stainless Steel Models only

Consult factory for Carbon Steel. Optional sizes, materials, baskets, gaskets and mesh liners are available on application.

Special Strainers

Fireline Strainers

U.L. approved strainers for fireline service are designed specifically for applications such as automatic water sprinklers and spray systems in firelines. The very large open area ratio helps prevent problems due to clogging of the screen. These units are available with open areas up to seven times the corresponding pipe size. This exceeds the AWWA requirements by almost 200%.

Whether the need is for a "Y" strainer or a basket strainer, Mueller cast iron fireline strainers from 2½" to 12" can meet your needs.

Fabricated Strainers

Mueller Steam Specialty has a long history of providing the highest quality, economical fabricated strainers to meet every need.

Whether the requirement is for a basket strainer, large "Y" strainer, "Tee" type strainer, temporary strainer or large duplex strainer, Mueller will custom engineer and fabricate the exact strainer required. Some of the special features available include:

- Special Dimensions
- Special Baskets
- Special Covers
(Lifting Davits, Quick Opening etc.)
- Special End Connections
- Special Corrosion Allowances
- Special Draining and Cleaning
- Special Certifications:
ASME code stamped, etc.

Meter Strainers

When expensive displacement water meters and other sensitive fluid monitoring devices need to be protected from damage due to particles and debris in the line and space is a problem, the Mueller Steam Specialty meter strainers are the solution.

These units have been designed to meet AWWA requirements of a straining area at least twice the size of the main meter case inlet of turbine type meters.

Available in cast iron and bronze from 1½" to 8", these units are designed to eliminate your meter protection problems.

Lead Free*

Model 595

Class 125

Cast Iron Flanged Ends, U.L. Approved for Fireline Service

- Size: 4" - 12" (100 - 300mm)
- 175psi WOG @ 150°F
- 12 bar @ 65°C



Model 911U

Class 125

Cast Iron Flanged Ends, U.L. Approved for Fireline Service

- Size: 4" - 12" (100 - 300mm)
- 175psi WOG @ 150°F
- 12 bar @ 65°C



Model 781 FAB

Class 150

Carbon Steel, Stainless Steel, and other Alloys, Flanged Ends

- Size 4" - 36" (100 - 900mm)

Model 782 FAB

Class 300

Carbon Steel, Stainless Steel, and other Alloys, Flanged Ends

- Size: 4" - 24" (100 - 600mm)

Model 784 FAB

Class 600

Carbon Steel, Stainless Steel, and other Alloys, Flanged Ends

- Size: 4" - 24" (100 - 600mm)



Model 781 WE-FAB

Class 150

Carbon Steel, Stainless Steel, and other Alloys, Weld Ends

- Size 4" - 36" (100 - 900mm)

Model 782 WE-FAB

Class 300

Carbon Steel, Stainless Steel, and other Alloys, Weld Ends

- Size: 4" - 24" (100 - 600mm)

Model 784 WE-FAB

Class 600

Carbon Steel, Stainless Steel, and other Alloys, Weld Ends

- Size: 4" - 24" (100 - 600mm)

Class 900 and higher available

Model 625

Class 125

Cast Iron Flanged Ends, Bolted Cover

- Size 3" - 8" (80 - 200mm)
- 175psi WOG @ 150°F
- 12 bar @ 65°C



Model 625-B

Class 150

Bronze Flanged Ends, Bolted Cover

- Size: 1½" - 8" (40 - 200mm)
- 175psi WOG @ 150°F
- 12 bar @ 65°C



Fabricated Strainers

Model 22

Basket Type

Carbon Steel, Stainless Steel and other Alloys

- Size: ¾" - 60" (20 - 1500mm)



Model 23

Conical Type

Carbon Steel, Stainless Steel, and other Alloys

- Size ¾" - 60" (20 - 1500mm)



Model 24

Plate Type

Carbon Steel, Stainless Steel, and other Alloys, Flanged Ends

- Size: ¾" - 60" (20 - 1500mm)



Model 185 FAB-B

Class 150

Carbon Steel, Stainless Steel, and other Alloys, Bolted Cover

- Size: 4" - 54" (100 - 1350mm)

Model 186 FAB-B

Conical Type

Carbon Steel, Stainless Steel, and other Alloys, Bolted Cover

- Size 4" - 48" (100 - 1200mm)

Model 188 FAB-B

Class 600

Carbon Steel, Stainless Steel, and other Alloys, Bolted Cover

- Size: 4" - 36" (100 - 900mm)

Model 185 FAB-Q

Class 150

Carbon Steel, Stainless Steel, and other Alloys, Quick Opening Cover

- Size: 4" - 36" (100 - 900mm)

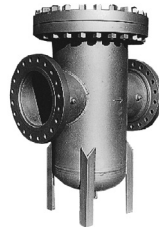

Model 41 T-B

Class 150

Carbon Steel, Stainless Steel, and other Alloys, Bolted Cover

- Size: 2" - 36" (50 - 900mm)



Model 42 T-B

Class 300

Carbon Steel, Stainless Steel, and other Alloys, Bolted Cover

- Size 2" - 36" (50 - 900mm)



Model 44 T-B

Class 600

Carbon Steel, Stainless Steel, and other Alloys, Bolted Cover

- Size: 2" - 36" (50 - 900mm)

Model 46 T-B

Class 900

Carbon Steel, Stainless Steel, and other Alloys, Bolted Cover

- Size: 2" - 36" (50 - 900mm)

Model 48 T-B

Class 1500

Carbon Steel, Stainless Steel, and other Alloys, Bolted Cover

- Size: 2" - 36" (50 - 900mm)

Model 41 T-Q

Class 150

Carbon Steel, Stainless Steel, and other Alloys, Quick Opening Cover

- Size: 2" - 36" (50 - 900mm)

Mueller Steam Specialty

has a long history of providing the highest quality, economical fabricated strainers to meet every need. From Class 150 to Class 2500, we produce steel and alloy fabricated strainers to your exact requirements.

Line Blinds

Model 15A

Class 150

Available Body Material:
Carbon Steel, Stainless Steel, and
other Alloys, Butt Weld

- Size: 1" - 48" (25 - 1200mm)



Model 150A

Class 1500

Available Body Material:
Carbon Steel, Stainless Steel, and
other Alloys, Butt Weld

- Size: 1" - 48" (25 - 1200mm)



Model 60A

Class 600

Available Body Material:
Carbon Steel, Stainless Steel, and
other Alloys, Butt Weld

- Size: 1" - 48" (25 - 1200mm)



Model 15AF

Class 150

Available Body Material:
Carbon Steel, Stainless Steel, and
other Alloys, Flanged Ends

- Size 1" - 48" (25 - 1200mm)



Model 150AF

Class 1500

Available Body Material:
Carbon Steel, Stainless Steel, and
other Alloys, Flanged Ends

- Size 1" - 48" (25 - 1200mm)



Model 60AF

Class 600

Available Body Material:
Carbon Steel, Stainless Steel, and
other Alloys, Flanged Ends

- Size 1" - 48" (25 - 1200mm)



Model 30A

Class 300

Available Body Material:
Carbon Steel, Stainless Steel, and other
Alloys, Butt Weld

- Size: 1" - 48" (25 - 1200mm)



Model 250A

Class 2500

Available Body Material:
Carbon Steel, Stainless Steel, and other
Alloys, Butt Weld

- Size: 1" - 48" (25 - 1200mm)



Model 90A

Class 900

Available Body Material:
Carbon Steel, Stainless Steel, and other
Alloys, Butt Weld

- Size: 1" - 48" (25 - 1200mm)



Model 30AF

Class 300

Available Body Material:
Carbon Steel, Stainless Steel, and other
Alloys, Flanged Ends

- Size: 1" - 48" (25 - 1200mm)



Model 250AF

Class 2500

Available Body Material:
Carbon Steel, Stainless Steel, and other
Alloys, Flanged Ends

- Size: 1" - 48" (25 - 1200mm)



Model 90AF

Class 900

Available Body Material:
Carbon Steel, Stainless Steel, and other
Alloys, Flanged Ends

- Size: 1" - 48" (25 - 1200mm)



Trust Mueller Steam Specialty

strainers & valves to handle the most demanding needs of the marine industry. We have a vast knowledge of product/service compatibility combined with an endless array of materials, sizes, pressures and end connections to meet your application requirements.

Pump Protection

Lead Free*

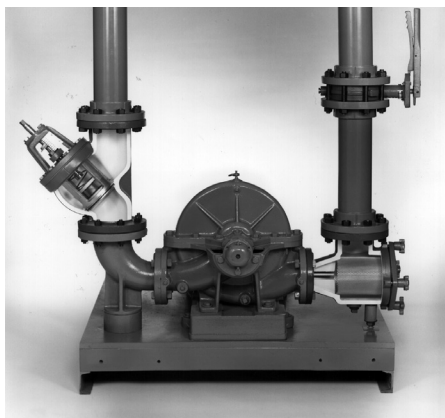

Mueller Steam Specialty Control-Chek Combination Valve and Suction Diffuser.

The Mueller Steam Specialty Pump Protection Package is a compact, effective and economical way to simplify the maze of piping found in most pump locations.

Our Control-Chek® valve has been specifically designed to incorporate balancing, shut off and check valve functions into one compact, easily installed unit. This saves space, installation cost and maintenance time.

The Suction Diffuser does more than just strain out particles that could damage your pump. By replacing the elbow, strainer and entry pipe on the suction side of the pump, a tremendous savings in space, equipment and labor will be realized. Our Control-Chek® and Suction Diffuser, together with an inlet control valve, can replace up to six costly, space-robbing pipe components. That does not include the savings due to fewer welds, hangers, flanges, ease of maintenance and improved access in the mechanical room. Both units are also available in our LOCKEND® line (See page 27).

Contact us for more information on these products.

Model 721



Class 125

Cast Iron Control-Chek®, Flanged Ends, Bolted Yoke Cover with Position Indicator

- Size: 2" - 14" (50 - 350mm)
- 2" - 12" 200psi WOG @ 150°F
(50 - 300mm) 13 bar @ 65°C
 - 14" 150psi WOG @ 150°F
(350mm) 10 bar @ 65°C

Model 722

Mode; 722G (LOCKEND®)

Class 300

Ductile Iron Control-Chek®

- Size: 2" - 12" (50 - 300mm)
- 2" - 10" 640psi WOG @ 100°F
(50 - 250mm) 44 bar @ 38°C
- 12" 500psi WOG @ 100°F
(300mm) 34 bar @ 38°C



Model 1011



Class 125

Cast Iron Flanged Ends, Knob Cover through 8" x 8"

Bolted Available through 18" x 18"

- Size: 2" x 1¼" - 12" x 12"
(50 x 32mm) - (300 x 300mm)
- 200psi WOG @ 150°F
- 13 bar @ 65°C

Consult factory for temperature & pressure data for bolted cover, larger sizes.

Model 1012



Class 300

Ductile Iron Flanged Ends, Knob Cover through 8" x 8"

Bolted available through 18" x 18"

- Size: 2" x 1¼" - 12" x 12"
(50 x 32mm - 300 x 300mm)
- 300psi WOG @ 100°F
- 20 bar @ 38°C

Consult factory for temperature & pressure data for bolted cover, larger sizes.

Model 1011G (LOCKEND®)

Class 300

Ductile Iron, Knob Cover through 8" x 8", Bolted available through 14" x 14"

Ends: Grooved inlet - Flanged Outlet

- Size: 2" x 1¼" - 12" x 12"
(50 x 32mm - 300 x 300mm)
- 300psi WOG @ 100°F
- 20 bar @ 38°C

Consult factory for temperature & pressure data for bolted cover, larger sizes.

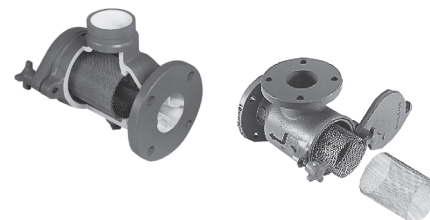

CHEXTER® Check Valve

The CHEXTER® Check Valves are designed to be used economically in a variety of commercial and industrial applications - including commercial construction, industrial, marine, utilities and process industries.

CHEXTER® Check valves meet the requirements of, and are approved for use by:

- General Services Administration
- U.S. Navy, the U.S. Coast Guard, U.S. Air Force and NASA
- Utility industry requirements for performance-Water, gas and compressed air lines

The CHEXTER® Check valve may be outfitted in a broad combination of metal trims allowing quick selection of the right valve for your application.



Model 1600-D

Class 125

Cast Iron body/Buna-N-Seal

Facing: Flat Face Flange Disc: 316SS

- Size: 2" - 36" (50 - 900mm)
- 2" - 12" 200psi WOG @ 150°F
(50 - 300mm) 14 bar @ 66°C
- 14" - 24" 150psi WOG @ 150°F
(350 - 600mm) 10 bar @ 66°C
- 30" & Up 150psi WOG @ 150°F
900mm 10 bar @ 66°C

Model 1600-DE

Class 125

Cast Iron body/Buna-N-Seal

Facing: Flat Face Flange Disc: Alum-Brz

- Size: 2" - 36" (50 - 900mm)
- 2" - 12" 200psi WOG @ 150°F
(50 - 300mm) 14 bar @ 66°C
- 14" - 24" 150psi WOG @ 150°F
(350 - 600mm) 10 bar @ 66°C
- 30" & Up 150psi WOG @ 150°F
900mm 10 bar @ 66°C

Model 1602-D

Class 250

Cast Iron body/Buna-N-Seal

Facing: Raised Flange Disc: Ductile Iron

- Size: 2" - 30" (50 - 760mm)
- 2" - 12" 500psi WOG @ 150°F
(50 - 300mm) 34 bar @ 66°C
- 14" - 24" 300psi WOG @ 150°F
(350 - 600mm) 21 bar @ 66°C
- 30" 300psi WOG @ 150°F
900mm 21 bar @ 66°C

Model 1602-DE

Class 250

Cast Iron body/Buna-N-Seal

Facing: Raised Flange Disc: Alum Brz

- Size: 2" - 24" (50 - 600mm)
- 2" - 12" 500psi WOG @ 150°F
(50 - 300mm) 34 bar @ 66°C
- 14" - 24" 300psi WOG @ 150°F
(350 - 600mm) 21 bar @ 66°C

Model 1601-A

Class 150

Carbon Steel body/Buna-N-Seal

Facing: Raised Flange Disc: Ductile Iron

- Size: 2" - 30" (50 - 750mm)
- 285psi WOG @ 100°F
- 20 bar @ 38°C

Model 1601-AC

Class 150

Carbon Steel body/Teflon Seal

Facing: Raised Flange Disc: 316SS

- Size: 2" - 30" (50 - 750mm)
- 285psi WOG @ 100°F
- 20 bar @ 38°C

Model 1601-AF

Class 150

Carbon Steel body/Metal-to-metal Seal

Facing: Raised Flange Disc: 316SS

- Size: 2" - 30" (50 - 750mm)
- 285psi WOG @ 100°F
- 20 bar @ 38°C

Model 1601-C

Class 150

316 SS body/Teflon Seal

Facing: Raised Flange Disc: 316SS

- Size: 2" - 12" (50 - 300mm)
- 275psi WOG @ 100°F
- 19 bar @ 38°C

Model 1601-E

Class 150

Aluminum bronze body/Teflon Seal

Facing: Raised Flange Disc: Alum-Brz

- Size: 2" - 12" (50 - 300mm)
- 195psi WOG @ 100°F
- 13 bar @ 38°C

CHEXTER® Check Valve

Model 1603-A

Class 300

Carbon Steel Body/Buna-N-Seal
Facing: Raised Flange Disc: Ductile Iron

- Size: 2" - 24" (50 - 600mm)
- 740psi WOG @ 100°F
- 51 bar @ 38°C

Model 1603-AC

Class 300

Carbon Steel Body/Teflon Seal
Facing: Raised Flange Disc: 316SS

- Size: 2" - 24" (50 - 600mm)
- 740psi WOG @ 100°F
- 51 bar @ 38°C

Model 1603-AF

Class 300

Carbon Steel Body/Metal-to-Metal Seal
Facing: Raised Flange Disc: 316SS

- Size: 2" - 24" (50 - 600mm)
- 740psi WOG @ 100°F
- 51 bar @ 38°C

Model 1603-C

Class 300

316 SS Body/Teflon Seal
Facing: Raised Flange Disc: 316SS

- Size: 2" - 12" (50 - 300mm)
- 720psi WOG @ 100°F
- 50 bar @ 38°C

Model 1603-E

Class 300

Aluminum Bronze Body/Teflon Seal
Facing: Raised Flange Disc: Alum-Brz

- Size: 2" - 12" (50 - 300mm)
- 515psi WOG @ 100°F
- 36 bar @ 38°C

Model 1604-A

Class 400

Carbon Steel Body/Buna-N-Seal
Facing: Raised Flange Disc: Ductile Iron

- Size: 2" - 24" (50 - 600mm)
- 990psi WOG @ 100°F
- 68 bar @ 38°C

Model 1605-A

Class 300

Carbon Steel Body/Buna-N-Seal
Facing: Raised Flange Disc: Ductile Iron

- Size: 2" - 24" (50 - 600mm)
- 1480psi WOG @ 100°F
- 102 bar @ 38°C

Model 1605-AC

Class 600

Carbon Steel Body/Teflon Seal
Facing: Raised Flange Disc: 316SS

- Size: 2" - 24" (50 - 600mm)
- 1480psi WOG @ 100°F
- 102 bar @ 38°C

Model 1605-AF

Class 600

Carbon Steel Body/Metal-to-Metal Seal
Facing: Raised Flange Disc: 316SS

- Size: 2" - 24" (50 - 600mm)
- 1480psi WOG @ 100°F
- 102 bar @ 38°C

Model 1605-C

Class 600

316 SS Body/Teflon Seal
Facing: Raised Flange Disc: 316SS

- Size: 2" - 12" (50 - 300mm)
- 1480psi WOG @ 100°F
- 99 bar @ 38°C

Model 1606-A

Class 900

Carbon Steel Body/Buna-N-Seal
Facing: Raised Flange Disc: Ductile Iron

- Size: 2" - 12" (50 - 300mm)
- 2120psi WOG @ 100°F
- 146 bar @ 38°C

Model 1606-AC

Class 900

Carbon Steel Body/Teflon Seal
Facing: Raised Flange Disc: 316SS

- Size: 2" - 12" (50 - 300mm)
- 2120psi WOG @ 100°F
- 146 bar @ 38°C

Model 1606-AF

Class 900

Carbon Steel Body/Metal-to-Metal Seal
Facing: Raised Flange Disc: 316SS

- Size: 2" - 12" (50 - 300mm)
- 2120psi WOG @ 100°F
- 146 bar @ 38°C

Model 1606-C

Class 900

316 SS Body/Teflon Seal
Facing: Raised Flange Disc: 316SS

- Size: 2" - 12" (50 - 300mm)
- 2010psi WOG @ 100°F
- 139 bar @ 38°C

How to Order CHEXTER® Check Valve

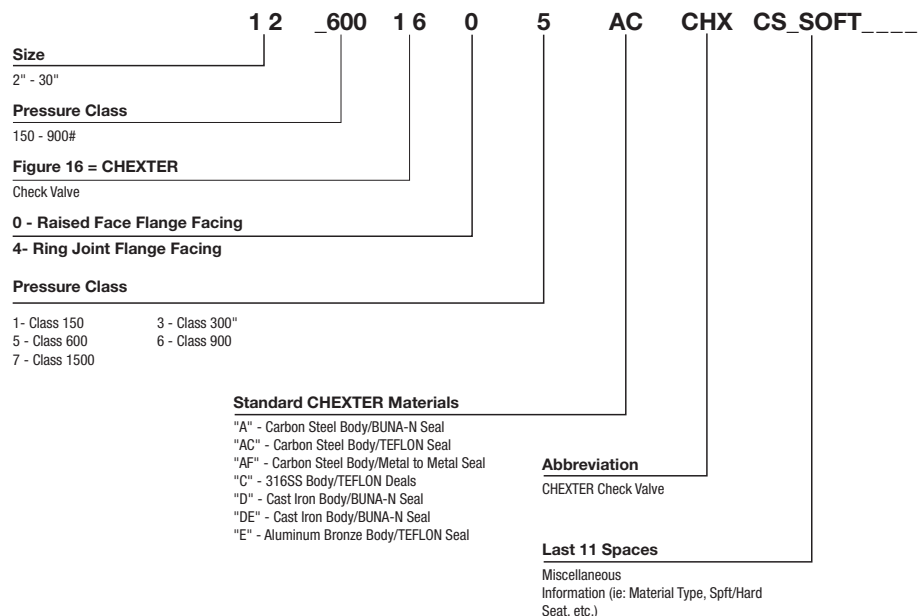

CHEXTER® Check Valve

Model 1645-A

Class 600

Carbon Steel Body/Buna-N-Seal
Facing: Ring Type Joint Disc: Ductile Iron

- Size: 2" - 12" (50 - 300mm)
- 1480psi WOG @ 100°F
- 102 bar @ 38°C

Model 1645-AC

Class 600

Carbon Steel Body/Teflon Seal
Facing: Ring Type Joint Disc: 316SS

- Size: 2" - 12" (50 - 300mm)
- 1480psi WOG @ 100°F
- 102 bar @ 38°C

Model 1645-AF

Class 600

Carbon Steel Body/Metal-to-Metal Seal
Facing: Ring Type Joint Disc: 316SS

- Size: 2" - 12" (50 - 300mm)
- 1480psi WOG @ 100°F
- 102 bar @ 38°C

Model 1645-C

Class 600

316 SS Body/Teflon Seal
Facing: Ring Type Joint Disc: 316SS

- Size: 2" - 12" (50 - 300mm)
- 1440psi WOG @ 100°F
- 99 bar @ 38°C

Model 1646-A

Class 900

Carbon Steel Body/Buna-N-Seal
Facing: Ring Type Joint Disc: Ductile Iron

- Size: 2" - 12" (50 - 300mm)
- 2120psi WOG @ 100°F
- 146 bar @ 38°C

Model 1646-AC

Class 900

Carbon Steel Body/Teflon Seal
Facing: Ring Type Joint Disc: 316SS

- Size: 2" - 12" (50 - 300mm)
- 2120psi WOG @ 100°F
- 146 bar @ 38°C

Model 1646-AF

Class 900

Carbon Steel Body/Metal-to-Metal Seal
Facing: Ring Type Joint Disc: 316SS

- Size: 2" - 12" (50 - 300mm)
- 2120psi WOG @ 100°F
- 146 bar @ 38°C

Model 1646-C

Class 900

316 SS Body/Teflon Seal
Facing: Ring Type Joint Disc: 316SS

- Size: 2" - 12" (50 - 300mm)
- 2120psi WOG @ 100°F
- 146 bar @ 38°C

Model 1696-A

Class 2000 Lb. API WOG

Carbon Steel Body/Buna-N-Seal
Facing: Ring Type Joint Disc: Ductile Iron
Unibody Style

- Size: 2" - 4" (50 - 100mm)
- 2000psi WOG @ 100°F
- 138 bar @ 38°C

Model 1607-A

Class 1500

Carbon Steel Body/Buna-N-Seal
Facing: Raised Flange Disc: Ductile Iron
Unibody Style

- Size: 2" - 10" (50 - 250mm)
- 3705psi WOG @ 100°F
- 255 bar @ 38°C

Model 1647-A

Class 1500

Carbon Steel Body/Buna-N-Seal
Facing: Ring Type Joint Disc: Ductile Iron
Unibody Style

- Size: 2" - 10" (50 - 250mm)
- 3705psi WOG @ 100°F
- 255 bar @ 38°C

Model 1697-A

Class 300 Lb. API WOG

Carbon Steel Body/Buna-N-Seal
Facing: Ring Type Joint Disc: Ductile Iron
Unibody Style

- Size: 2" - 4" (50 - 100mm)
- 3000psi WOG @ 100°F
- 207 bar @ 38°C

Silent Check Valves - Wafer Style

Lead Free*

Mueller Steam Specialty Silent Check Valves are designed with a spring assisted in-line disc that is guided both upstream and downstream. This design feature allows valve closure at zero flow. Flow reversal does not occur and check valve induced water hammer is eliminated.

The Mueller Wafer Silent Check Valve is designed with a short face-to-face dimension and fits conveniently between two matching flanges. Only a limited amount of space is needed for installation and installation time is reduced. The valves are used in a variety of liquid, air and gas applications. These units are available in cast iron, bronze, carbon steel, stainless steel and other alloys.

Standard Wafer



Model 101 MAT

Class 125

Cast Iron Body/Stainless Steel Trim

- Size: 1" - 10" (25 - 250mm)
- 200psi WOG @ 150°F
- 13 bar @ 65°C

Model 103 MAT

Class 250

Cast Iron Body/Stainless Steel Trim

- Size: 1" - 10" (25 - 600mm)
- 500psi WOG @ 150°F
- 34 bar @ 65°C

Model 101 MDT

Class 150

Carbon Steel Body/316 SS Trim

- Size: 1" - 10" (25 - 250mm)
- 285psi WOG @ 100°F
- 19 bar @ 38°C

Model 103 MDT

Class 300

Carbon Steel Body/316 SS Trim

- Size: 1 - 10" (25 - 250mm)
- 740psi WOG @ 100°F
- 51 bar @ 38°C

Model 131 DT

Class 600

Carbon Steel Body/316 SS Trim

- Size: 1" - 6" (25 - 150mm)
- 1480psi WOG @ 100°F
- 102 bar @ 38°C

Model 101 MHT

Class 150

Carbon Steel Body/316 SS Trim

- Size: 1" - 10" (25 - 250mm)
- 275psi WOG @ 100°F
- 19 bar @ 38°C

Model 103 MHT

Class 300

Carbon Steel Body/316 SS Trim

- Size: 1" - 10" (25 - 250mm)
- 720psi WOG @ 100°F
- 49 bar @ 38°C

Model 131 HT

Class 600

Carbon Steel Body/316 SS Trim

- Size: 1" - 6" (25 - 150mm)
- 1440psi WOG @ 100°F
- 99 bar @ 38°C

Compact Wafer



Model 91AT

For use w/Class 125, 150, 250 or 300 flanges

Cast Iron Body/316 SS Trim

- Size: 1 ½" - 6" (40 - 150mm)
- 150psi WOG @ 150°F
- 10 bar @ 65°C

Model 92AT

For use w/Class 125 or 150 flanges

Cast Iron Body/Bronze Trim

- Size: 8" - 12" (200 - 300mm)

Silent Check Valves - Globe Style

Lead Free*

With the same design features as the wafer silent check valves, the Globe style valves offer a more streamlined flow and lower pressure drop figures.

The valves are designed for liquid, air and gas service* and are available in a complete range of sizes, body trim materials and pressure classes.

These valves are engineered to be partially open at 0.5psi and fully open at 1psi differential pressure at a liquid velocity of 8 feet per second.

Mueller Globe Style Silent Check Valves can be installed in horizontal or vertical flow. Each valve is 100% tested in accordance with ANSI, API and MSS standards

Globe Styles

NPT Type

Model 105 MAT

Class 125



- Cast Iron Body/316 SS Trim
- Size: 2" - 24" (50 - 600mm)
 - 2" - 12"
 - 200psi WOG @ 150°F
13 bar @ 65°C
 - 14" - 24"
 - 150PSI WOG @ 150°F
10 Bar @ 65°C

Model 107 MAT

Class 250



- Cast Iron Body/316 SS Trim
- Size: 2" - 24" (50 - 600mm)
 - 2" - 12"
 - 500 PSI WOG @ 150°F
34 Bar @ 65°C
 - 14" - 24"
 - 300PSI WOG @150°F
20 Bar @ 65°C

Model 105 MDT

Class 150

- Carbon Steel Body/316 SS Trim
- Size: 2" - 30" (50 - 750mm)
 - 285psi WOG @ 100°F
 - 19 bar @ 38°C

Model 109 MDT

Class 300

- Carbon Steel Body/316 SS Trim
- Size: 2" - 24" (50 - 600mm)
 - 740psi WOG @ 100°F
 - 51 bar @ 38°C

Model 113 DT

Class 600

- Carbon Steel Body/316 SS Trim
- Size: 2" - 10" (50 - 250mm)
 - 1480psi WOG @ 100°F
 - 102 bar @ 38°C

Model 117 DT

Class 1500

- Carbon Steel Body/316 SS Trim
- Size: 2" - 24" (50 - 600mm)
 - 3705psi WOG @ 100°F
 - 255 bar @38°C

Model 105 MHT

Class 150

- 316 SS Body/316 SS Trim
- Size: 2" - 30" (50 - 750mm)
 - 275psi WOG @ 100°F
 - 18 bar @ 38°C

Model 109 MHT

Class 300

- 316 SS Body/316 SS Trim
- Size: 2" - 24" (50 - 600mm)
 - 720psi WOG @ 100°F
 - 49 bar @ 38°C

Model 113 HT

Class 600

- 316 SS Body/316 SS Trim
- Size: 2" - 10" (50 - 250mm)
 - 1440psi WOG @ 100°F
 - 99 bar @ 38°C

Model 117 HT

Class 1500

- 316 SS Body/316 SS Trim
- Size: 2" - 24" (50 - 600mm)
 - 3600psi WOG @ 100°F
 - 248 bar @ 38°C

Model 303 AT

Class 250

- Cast Iron Body/316 SS Trim
EPDM Soft Seat Option Available
- Size: ¼" - 2" (8 - 50mm)
 - 200psi WOG @ 150°F
 - 13 bar @ 65°C



Model 303 HT

Class 300

- 316 SS Body/316 SS Trim
Optional Viton® Soft Seat Available
- Size: ¼" - 2" (8 - 50mm)
 - 600psi WOG @ 100°F
 - 41 bar @ 38°C

* Do not use directly on discharge of reciprocating compressors.

Silent Check Valves

Lead Free*

How to Order

Model Numbers

These numbers describe valves furnished with standard trim. For any other type of trim refer to "Body Materials" table and "Trim Materials" table on this page. Substitute the correct letter indicating the trim materials which you require.

Body Material	Trim	ANSI Class	Compact Wafer Type	Full Face Wafer Type	Globe Type	NPT
Cast Iron	Stainless Steel	125	91AT*		105MAT	
Cast Iron	Stainless Steel	250			107MAT	303AT
Carbon Steel	Stainless Steel	150		101MDT	105MDT	
Carbon Steel	Stainless Steel	300		103MDT	109MDT	
Carbon Steel	Stainless Steel	600		131DT	113DT	
Carbon Steel	Stainless Steel	1500			117DT	
316 SS	Stainless Steel	150		101MHT	105MHT	
316 SS	Stainless Steel	300		103MHT	109MHT	303HT
316 SS	Stainless Steel	600		131HT	113HT	
316 SS	Stainless Steel	1500			117HT	

* Sizes 1½" - 6" (40 - 150mm)

+ Sizes 8" - 12" (200 - 300mm)

** DuPont Trademark

	Description	Code
Body Material	Cast Iron (Semi-Steel)	A
	Bronze, 85-5-5-5	B
	Bronze, "M" Metal	C
	Carbon Steel, Gr. WCB	D
	Carbon Moly, Gr. WCI	E
	Stainless, Type 410	F
	Stainless, Type 304	G
	Stainless, Type 316	H
	Ductile Iron	I
	Aluminum	J
Other - Specify	X	
Trim Material	Stainless, Type 410	R
	Stainless, Type 304	S
	Stainless, Type 316	T
	Monel	U
	Carbon Steel	V
	Other - Specify	X

Soft Seat available in EPDM, Buna-N and Viton®. Consult Factory.

Model # Code Example 8 105 M D T X

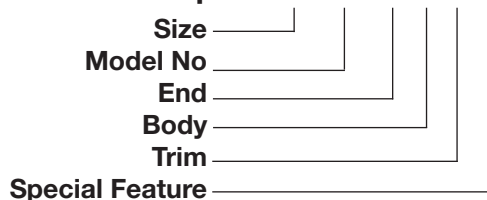

Consult factory for all special features. If no special features are required use "O" in place of "X" in the ordering and tagging number.

Ordering Information

Important! To assist you in ordering the proper product for your application, the following information is necessary: operating pressure, temperature, flow rates and/or velocity and the type of service used.

Double Disc Check Valves - SURE CHECK®

Lead Free*

The unique torsion spring arrangement on this valve forces the heel of the discs against the seat for a complete seal. It also helps close the disc on flow stoppage, minimizing flow reversal and water hammer.

Elastomer seats for each disc are molded to the body allowing complete sealing. Metal-to-metal seating is also available on request. The dual shaft design provides a positive disc stop. This feature minimizes flutter and wear at the disc hinge and maximizes the life of the valve.

All steel, stainless steel and alloy models conform to API 594 and API 6D specifications. (Also available as LOCXEND. See pages 27 & 28)

The Sure Check valves are designed for horizontal and vertical flow applications. Units are available in cast iron, ductile iron, carbon steel, stainless steel and other alloys.

316 stainless steel disc is standard on all models with the exception of the 71U (UL certified) check valve.



Model 71

Class 125

Cast Iron Body/SS Disc

- Size: 2" - 54" (50 - 1350mm)
- 2" - 12" 200psi @ 150°F
- (50 - 300mm) 13 bar @ 65°C
- 14" - 54" 150psi @ 150°F
- (350 - 7350mm) 10 bar @ 65°C

Model 71U

Ductile Iron Body/Aluminum/Bronze Disc

U.L. FM Approved

- Size: 4" - 12" (100 - 300mm)
- 175psi WOG @ 150°F
- 12 bar @ 65°C

Model 72

Class 150

Bronze, 2" - 54" (50 - 1350mm)

Ductile Iron,
Carbon Steel, Stainless Steel Bodies Available

- Size: 2" - 56" (50 - 1400mm)
- 285psi WOG @ 100°F
- 19 bar @ 38°C

Model 74

Class 300

Bronze, Carbon Steel, Stainless Steel Bodies Available

- Size: 2" - 48" (50 - 1200mm)
- 740psi WOG @ 100°F
- 51 bar @38°C

Model 76

Class 600

Carbon Steel, Stainless Steel Bodies Available

- Size: 2" - 42" (50 - 1050mm)
- 1480psi @ 100°F
- 102 bar @ 38°C

Model 77

Class 900

Carbon Steel, Stainless Steel Bodies Available

- Size: 2" - 24" (50 - 600mm)
- 2220psi WOG @ 100°F
- 151 bar @ 38°C*

Model 78

Class 1500

Carbon Steel, Stainless Steel Bodies Available

- Size: 2" - 18" (50 - 450mm)
- 3705psi WOG @ 100°F
- 255 bar @ 38°C*

Model 79

Class 2500

Carbon Steel, Stainless Steel Bodies Available

- Size: 2" - 12" (50 - 300mm)
- 6170psi WOG @ 100°F
- 425 bar @38°C

* Pressure-Temperature Rating for
Carbon Steel Models only

Consult factory for Stainless Steel or other materials.

Double Disc Check Valves - SURE CHECK®

Lead Free*

Example

Six inch, Model 71, cast iron body, 316 SS shaft, ductile iron disc, Buna-N seat, 316 SS spring, no special features.

Model # Code Example

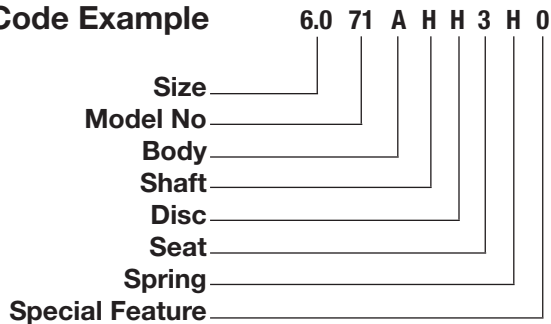

Consult factory for all special features. If no special features are required, use "O" in place of "X" in the ordering and tagging number.

Ordering Information

Important: To assist you in ordering the proper product for your application, the following information is necessary: operating pressure, temperature, flow rates and/or velocity and the type of service used.

	Material	Code	Material	Code
Body	Carbon Steel	D	Bronze B-62	B
	Cast Iron	A	Aluminum	J
	316 SS	H	Ductile Iron	I
Shaft	316 SS	H	Monel	Q
Disc	Carbon Steel	D	316 SS	H
	Ductile Iron	I	Aluminum	J
	Bronze B-62	B	Overlay -See "Special Feature"	X
Seat	Buna-N (-20° TO 250° F)	3	Monel Overlay	Q
	Neoprene (-40° TO 250° F)	8	316L SS Overlay	T
	EPDM (-40° TO 300° F)	6	410 SS Overlay	F
	Viton®* (-20° TO 400° F)	4	Aluminum-Bronze Overlay	K
			Stellite #6 Overlay	V
Repeat Body Material code in this position for metal-to-metal seat without overlay.				
Spring	316 SS (up to 250° F)	H	Inconel 600 (up to 650° F)	W
	Inconel X (up to 1000° F)	X	Monel	Q

Material Specifications

Body

Cast Iron ASTM A126-B (Semi-Steel)
 Carbon Steel ASTM A216 WCB
 316 SS (CF8M) ASTM A351
 Bronze (85-5-5-5) ASTM B62
 Aluminum ASTM B26-52T Gr. SG 70A
 Ductile Iron ASTM A536

Shaft

316 SS ASTM A479
 Monel ASTM B164

Discs

Ductile Iron ASTM A536
 Bronze (85-5-5-5) ASTM B62
 316 SS (CF8M) ASTM A351
 Carbon Steel ASTM A216 WCB
 Aluminum ASTM B26-52T Gr. SG 70A

Elastometer Seats

Buna-N
 Neoprene
 EPDM
 Viton®

Special Features

Welded Metal Overlays
 Micron Smooth Finished Ends
 Ring Joint Ends
 Epoxy Coated
 Drain Connections

Consult Factory, we can overlay with weldable materials.

Butterfly Valves

Lead Free*

Mueller Steam Specialty Butterfly Valves are designed for ANSI Class 125/150 flanges and in compliance with MSS-SP-25, MSS-SP-67, API-609 and MIL-V-22122C ships, Type 1, Classes A-D. MSS Butterfly Valves are also approved by the American Bureau of Shipping (ABS).

All valves are 100% factory tested to guarantee bi-direction, drop tight shutoff at full rated pressure.

The Mueller Steam Specialty Butterfly Valve offers numerous features, such as blow out proof stems, primary and secondary stem seals and multiple combinations of materials and configurations.

Ease of repair and actuation are just a few more reasons why Mueller Steam Specialty is an industry leader.

Model 88

Lug Style, Ductile Iron Body, 2" - 24"
Seats: Buna-N, EPDM, Viton®
Stems: 416 SS, 316 SS
Discs: Aluminum Bronze, Stainless Steel

- Size: 2" - 12" (50 - 300mm)
- 200psi WOG @ 100°F
- 13 bar @ 38°C



Model 90

High Performance, Lug Style,
Carbon Steel Body, 2" - 40"
Seats: RPTFE
Stem: 316L SS
Disc: 316 SS

- Size: 2" - 40" (50 - 600mm)
- 290psi WOG



How to Order Mueller Steam Specialty Model 88 Butterfly Valves

Example: 04.0-88IHH61

This is a 4" lugged body valve with a ductile iron body, 316 SS stem, 316 SS Disc, EPDM Seat and a ten position handle

4.0 - 88 - IHH - 6 - 1

Size: _____

Model: _____

- 88 - Full Lug (Replaces previous Model 66M)
- 90 - High Performance Lug

Body: _____

- I - Ductile Iron
- C - Carbon Steel (Series 90 Only)

Stem: _____

- H - 316SS Series 88 (2" - 12"), Series 90 (2" - 40")
- P - 431SS Series 88 (14" - 24")

Disc: _____

- H - 316SS

Seat: _____

- 4 - Viton
- 6 - EPDM
- 8 - RPTFE (Series 90 Only)

Operator: _____

- 1 - 10-Position Lever handle (Lockable in both open and closed positions)
- 5 - Gear Operator (Recommended for 10" and above)
- E - Electric Actuator

LOCXEND® - Grooved End Products

Lead Free*

For fast and economical installation of piping systems, grooved end equipment is often specified. The Mueller Steam Specialty LOCXEND® family of products is the economical choice. With over 60 years of experience in flow control products, Mueller Steam Specialty has designed and produced a complete line of grooved end pipeline products. This line includes the Sure Check® check valve, the Mueller butterfly valve, pump protection products (Control-Chek® combination valve and the suction diffuser) and both "Y" and Tee strainers.

As with all Mueller products, the LOCXEND® products are 100% hydrostatically tested so that our customers are assured of consistent high quality materials and construction.

Model 74G

Ductile Iron Body Sure Check®, Bronze Discs, Grooved End Connections
Seat: Buna-N Vulcanized Seat

- Size: 3" - 6" (80 - 150mm)
- 640psi WOG @ 100°F
- 44 bar @ 38°C
- 8" - 12" 500psi WOG @ 100°F



Model 722G

Ductile Iron Control-Chek®, Combination Valve, Grooved End Connections Bolted Yoke Cover, with Position Indicator

- Size 2" - 12" (50 - 300mm)
- 2" - 10" 640psi WOG @ 100°F (50- 250mm) 44 bar @ 38°C
- 12" 500psi WOG @ 100°F (300mm) 34 bar @ 38°C



Model 1011G

Class 150

Ductile Iron Body Suction Diffuser Grooved Inlet, Flanged Outlet, Knob Cover through 8" x 8" (200 x 200mm)

- Bolted available for all sizes
- Size: 2" x 1¼" - 12" x 12" (50 x 32mm - 300 x 300mm)
 - 300psi WOG @ 100°F
 - 20 bar @ 38°C



Model 758G

Ductile Iron Body "Y" Strainer Grooved End Connections Bolted Ductile Iron Cover

- Size: 2" - 12" (50 - 300mm)
- 640psi WOG @ 100°F
- 44 bar @ 38°C



Model 42T-G-Q

Ductile Iron Body "Tee" Strainer, Grooved End Connections, Clamped Ductile Iron Cover



- Size: 2" - 12" (50 - 300mm)
- 2" - 5" 750psi WOG @ 100°F (50 - 125mm) 51 bar @ 38°C
- 6" 700psi WOG @ 100°F (150mm) 48 bar @ 38°C
- 8" 600psi WOG @ 100°F (200mm) 41 bar @ 38°C
- 10" 500psi WOG @ 100°F (250mm) 34 bar @ 38°C
- 12" 400psi WOG @ 100°F (300mm) 27 bar @ 38°C

LOCXEND® - Grooved End Products

How to Order

Since the LOCXEND® Sure Check® Valve can be ordered with a choice of disc and seat materials, the table shown should be used for ordering.

Example: Six inch Model 74G, with ductile iron body, bronze disc, Buna-N seat, 316 SS spring, with no special features would have the ordering number shown with the table.

	Material	Code
Body	Ductile Iron	I
	316 Stainless Steel	H
Disc	Carbon Steel	D
	Ductile Iron	I
	Bronze B62	B
	316 Stainless Steel	H
Seat	Buna-N (-20 to 250° F)	3
	Neoprene (-40 to 250° F)	8
	EPDM (-40 to 300° F)	6
	Teflon*(-200 to 450° F)	7
	Viton®*(-20 to 400° F)	4
Spring	316 Stainless Steel	H

Model # Code Example

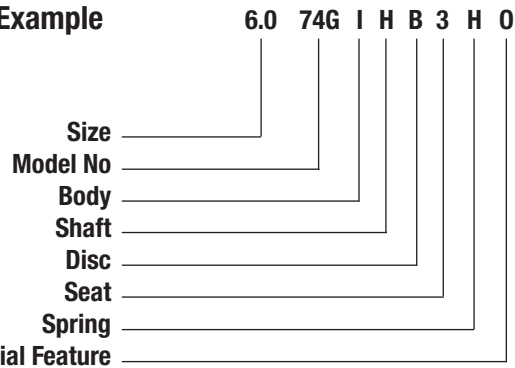

Consult factory for all special features. If no special features are required use "O" in place of "X" in the ordering and tagging number.

The LOCXEND® Butterfly Valve can be ordered with a choice of operators. The table below should be used when ordering.

Example: Two inch Model 89GEN with EPDM encapsulated disc and no operator.

Ordering information

Important: To assist you in ordering the proper LOCXEND® product for your application, the following information is necessary: operating pressure, temperature, flow rates and/or velocity and the type of pump used in the installation. If special screens are required for suction dif-fusers, "Y" Strainers or "Tee" Strainers, the particle retention size should be specified. Advise factory when corrosive fluids are involved.



Notes



Notes



Notes



Notes

Complete Mueller Steam Specialty Representative
information available at:

MuellerSteam.com



A WATTS Brand

USA: T: (800) 334-6259 • F: (800) 421-6772 • MuellerSteam.com
Latin America: T: (52) 55-4122-0138 • MuellerSteam.com