

# Installation, Maintenance, & Repair

## Colt™ Series C200a, C300a

Double Check Valve Assemblies  
Double Check Detector Assemblies

Sizes: 2½" – 6" (65-150mm)

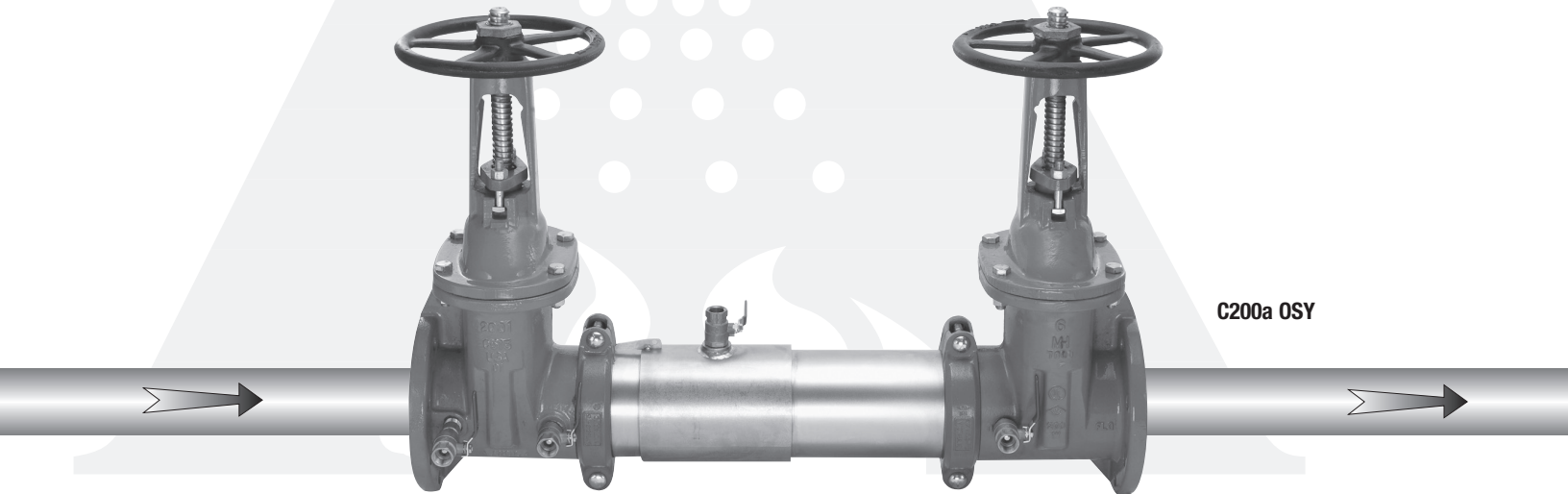

### ⚠ WARNING



Read this Manual **BEFORE** using this equipment.

Failure to read and follow all safety and use information can result in death, serious personal injury, property damage, or damage to the equipment.



Keep this Manual for future reference.

### ⚠ WARNING

You are required to consult the local building and plumbing codes prior to installation. If the information in this manual is not consistent with local building or plumbing codes, the local codes should be followed. Inquire with governing authorities for additional local requirements.

### ⚠ WARNING

**Need for Periodic Inspection/Maintenance:** This product must be tested periodically in compliance with local codes, but at least once per year or more as service conditions warrant. If installed on a fire suppression system, all mechanical checks, such as alarms and backflow preventers, should be flow tested and inspected in accordance with NFPA 13 and/or NFPA 25. All products must be retested once maintenance has been performed. Corrosive water conditions, and/or unauthorized adjustments or repair could render the product ineffective for the service intended. Regular checking and cleaning of the product's internal components helps assure maximum life and proper product function.

### NOTICE

For Australia and New Zealand, line strainers should be installed between the upstream shutoff valve and the inlet of the backflow preventer.

### NOTICE

Due to shipping, storage, and general handling, the Victaulic Coupling for the shutoff valves may have loosened and should be retightened during installation.

### Testing

For field testing procedure, refer to Ames installation sheets IS-A-ATG-1 found on [www.amesfirewater.com](http://www.amesfirewater.com).

For other repair kits and service parts, refer to our Backflow Prevention Products Repair Kits & Service Parts price list PL-A-RP-BPD found on [www.amesfirewater.com](http://www.amesfirewater.com).

For technical assistance, contact your local Ames representative.

# Basic Installation Instructions

## Guidelines

Most field problems occur because dirt and debris present in the system at the time of installation becomes trapped in the check valves. **The system should be flushed before the valve is installed.** If the system is not flushed until after the valve is installed, remove both check modules from the valve and open the inlet shutoff to allow water to flow for a sufficient time to flush debris from the water line. If debris in the water system continues to cause fouling, a strainer can be installed upstream of the backflow assembly.

The Series C200a and C300a may be installed in either horizontal or vertical position as long as the backflow assembly is installed in accordance with the direction of the flow arrow on the assembly and the local water authority approves the installation. The assembly should be installed with adequate clearance around the valve to allow for inspection, testing and servicing. 12" (300mm) should be the minimum clearance between the lower portion of the assembly and the floor or grade.

### NOTICE

Assembly body should not be painted.

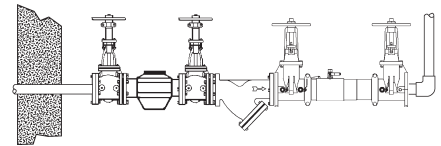

Horizontal Installation

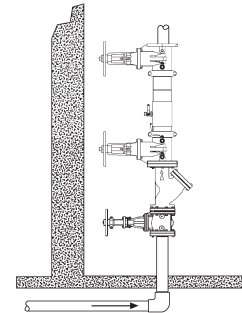

Vertical Installation

## Maintenance Instructions

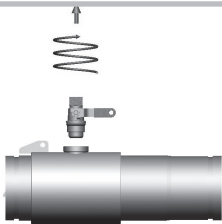

Figure A

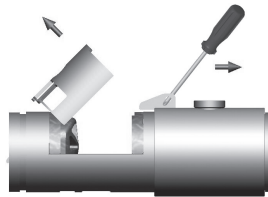

Figure B

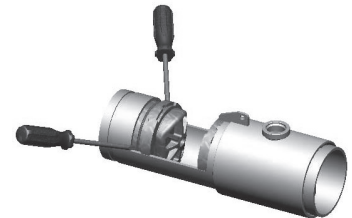

Figure C

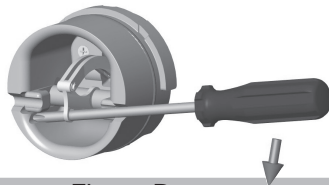

Figure D

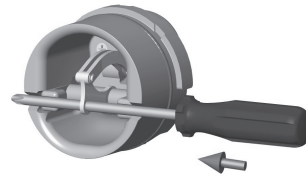

Figure E



Figure F

## Instructions

### WARNING

Prior to servicing any Ames valve, it is mandatory to shut down the water system by closing both the inlet and outlet shutoff valves.

### WARNING

While the spring mechanism is removed for check servicing, never pull the screwdriver out or off the support notches on the arbors. Doing so may cause bodily injuries. Keep fingers out of seat and clapper area.

After shutoff valves are closed, open test cock #2, #3 & #4 to relieve pressure within the backflow assembly. (Figure C on page 6.)

1. After #3 test cock has been opened to relieve pressure, remove #3 test cock from housing. (Figure A)
2. Insert a #3 screwdriver through the hole on the top of the cover sleeve and using both hands rotate the cover sleeve approximately 1/4-turn clockwise and 1/4-turn counter-clockwise to break the sleeve O-ring seals. Using the screwdriver, slowly slide the cover sleeve to the downstream side of the housing. (Figure B)
3. Remove the stainless steel check retainer from the housing. (Figure B)
4. Remove the #1 check module (Figure C) by inserting two flat blade screwdrivers into the slots on either side of the check module and gently pry the check module toward the open zone.
5. Remove #2 check module with the same instructions as in #4 above.
6. To clean or inspect either check module, insert a #3 screwdriver through the downstream side of the check module as shown in Figure D & E. When the screwdriver is in place, remove the "E"-clip (Figure F) and pin connecting the structural members and the check clapper will open with no tension.
7. Thoroughly clean the seating area. The sealing disc may be removed, if necessary, by removing the screws connecting the keeper plate to the clapper. The sealing disc may be reversed and reinstalled if the elastomer is cut or damaged.
8. Wash check module and O-ring and inspect for any damage. If damaged, reinstall new parts.
9. After thorough cleaning, lubricate O-ring w/FDA approved lubricant, replace pin and "E"-clip in structural members, remove screw driver and reinstall check modules and assemble housing in reverse order of these instructions.

# Parts

---

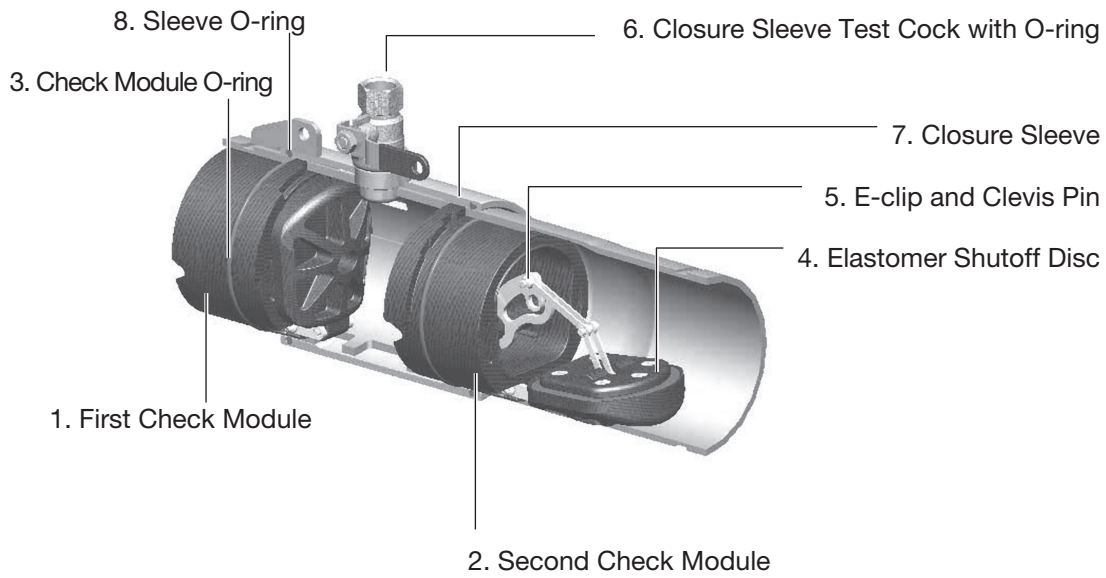

For repair kits and parts, refer to our Backflow Prevention Products Repair Kits & Service Parts price list PL-A-RP-BPD found on [www.amesfirewater.com](http://www.amesfirewater.com).

# Testing — Double Check Valve Assemblies

## Test Check Valve No. 1

- Step 1: Ensure shutoff #1 is open, shutoff #2 is closed.
- Step 2: Connect high side hose to test cock #3, low side to test cock #2 and open both test cock #2 and test cock #3.
- Step 3: Open valve C, then open A to bleed air from the high side. Close valve A, then open B to bleed low side. Close valve B.
- Step 4: Connect vent hose loosely to test cock# 1. Open valve A to vent air from vent hose, Tighten vent hose at test cock #1, open test cock #1.
- Step 5: Close shutoff #1. Slowly loosen hose at test cock #2 until differential gauge rises to 2psi and retighten hose. If the differential reading does not decrease, record check valves as "tight".

## Test Check Valve No. 2

- Step 1: Move the high side hose to test cock #4, low side to test cock #3 and open both test cock #3 and test cock #4. Remove vent hose from test cock #1, open shutoff #1.
- Step 2: Open valve C, then open valve A to bleed air from the high side. Close valve A, then open valve B to bleed low side. Close valve B.
- Step 3: Connect vent hose loosely to test cock #1. Open valve A to vent air from the vent hose. Tighten vent hose at test cock #1, open test cock #1.
- Step 4: Close shutoff #1, and then slowly loosen hose at test cock #3 until differential gauge rises to 2psi and retighten hose. If the differential reading does not decrease, record check as tight. Remove all hoses and restore valve to original working condition.

### NOTICE

The assembly will fail both the first and second check valve tests above, if shutoff #2 leaks excessively. To test for a leaky #2 shutoff, use the following procedure.

## Test for Leaky No. 2 shutoff

- Step 1: Connect the high side to test cock #1, low side to test cock #4. Open test cock #1 and test cock #4. Close shutoffs #1 and #2.
- Step 2: Close valve C. Open valve A, then open valve B 1/2 turn, loosen hose at test cock #4 to remove air. Retighten hose.
- Step 3: If the differential gauge rises above 0, there is excessive leakage at shutoff #2 and it must be replaced to test the assembly.

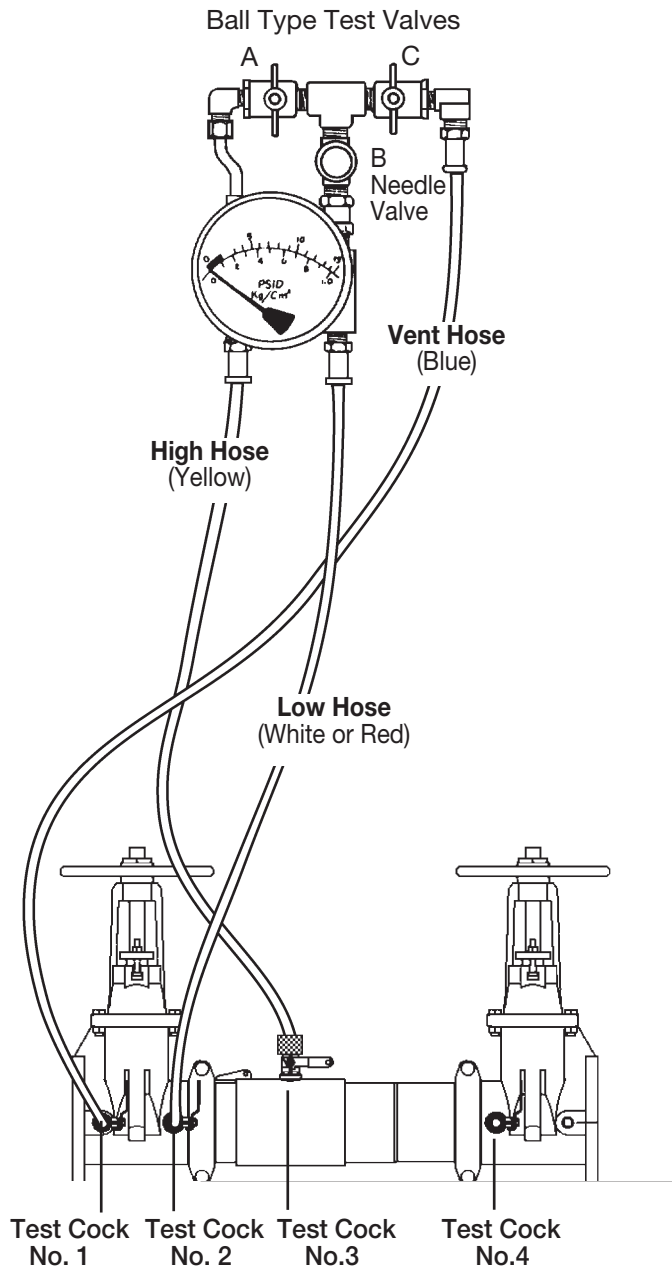

**Limited Warranty:** Ames Fire & Waterworks (the "Company") warrants each product to be free from defects in material and workmanship under normal usage for a period of one year from the date of original shipment. In the event of such defects within the warranty period, the Company will, at its option, replace or recondition the product without charge.

**THE WARRANTY SET FORTH HEREIN IS GIVEN EXPRESSLY AND IS THE ONLY WARRANTY GIVEN BY THE COMPANY WITH RESPECT TO THE PRODUCT. THE COMPANY MAKES NO OTHER WARRANTIES, EXPRESS OR IMPLIED. THE COMPANY HEREBY SPECIFICALLY DISCLAIMS ALL OTHER WARRANTIES, EXPRESS OR IMPLIED, INCLUDING BUT NOT LIMITED TO THE IMPLIED WARRANTIES OF MERCHANTABILITY AND FITNESS FOR A PARTICULAR PURPOSE.**

The remedy described in the first paragraph of this warranty shall constitute the sole and exclusive remedy for breach of warranty, and the Company shall not be responsible for any incidental, special or consequential damages, including without limitation, lost profits or the cost of repairing or replacing other property which is damaged if this product does not work properly, other costs resulting from labor charges, delays, vandalism, negligence, fouling caused by foreign material, damage from adverse water conditions, chemical, or any other circumstances over which the Company has no control. This warranty shall be invalidated by any abuse, misuse, misapplication, improper installation or improper maintenance or alteration of the product.

Some States do not allow limitations on how long an implied warranty lasts, and some States do not allow the exclusion or limitation of incidental or consequential damages. Therefore the above limitations may not apply to you. This Limited Warranty gives you specific legal rights, and you may have other rights that vary from State to State. You should consult applicable state laws to determine your rights. **SO FAR AS IS CONSISTENT WITH APPLICABLE STATE LAW, ANY IMPLIED WARRANTIES THAT MAY NOT BE DISCLAIMED, INCLUDING THE IMPLIED WARRANTIES OF MERCHANTABILITY AND FITNESS FOR A PARTICULAR PURPOSE, ARE LIMITED IN DURATION TO ONE YEAR FROM THE DATE OF ORIGINAL SHIPMENT.**

**WARNING:** This product contains chemicals known to the State of California to cause cancer and birth defects or other reproductive harm.  
For more information: [www.watts.com/prop65](http://www.watts.com/prop65)



[www.amesfirewater.com](http://www.amesfirewater.com)

ISO 9001-2008  
CERTIFIED

A Watts Water Technologies Company

USA: Backflow- Tel: (916) 928-0123 • Fax: (916) 928-9333

Control Valves- Tel: (713) 943-0688 • Fax: (713) 944-9445

Canada: Tel: (905) 332-4090 • Fax: (905) 332-7068