

Engineering Specification

Job Name _____

Contractor _____

Job Location _____

Approval _____

Engineer _____

Contractor's P.O. No. _____

Approval _____

Representative _____

LEAD FREE*

Series LF825Y Reduced Pressure Zone Assemblies

3/4" – 2"

FEBCO Series LF825Y Reduced Pressure Zone assemblies are used to protect against high hazard (toxic) fluids in water services to industrial plants, hospitals, morgues, mortuaries, and chemical plants. Applications also extend to irrigation systems, boiler feed, water lines, and other installations requiring maximum protection. The series features Lead Free* construction to comply with Lead Free* installation requirements.

The series includes a flood sensor to detect excessive water discharges from the relief valve. The sensor is installed on the assembly exterior and does not alter assembly functions or certifications. The sensor relays a signal that triggers notification to facility personnel for corrective action, thus limiting flooding and costly damage.

NOTICE

An add-on connection kit is required to activate the sensor. Without the connection kit, the sensor is a passive component that has no communication with any other device. (For more information download RP/IS-F-825Y.)

Features

- Ultimate mechanical protection of potable water, against hazards of cross-connection contamination
- Meets all specifications of AWWA, ASSE, and CSA
- Approved by the Foundation for Cross-Connection Control and Hydraulic Research at the University of Southern California
- Modular relief valve for ease of maintenance
- Simple service procedures
- All internal parts serviceable in line
- Low head loss
- Spring loaded "Y" type check valves
- Internal relief valve pressure sensing passages
- Replaceable seat rings on all sizes
- End connection – NPT ANSI/ASME B1.20.1
- Sensor on relief valve for flood detection
- Flood alerts feature activated with add-on sensor connection kit, compatible with BMS and cellular communication

*The wetted surface of this product contacted by consumable water contains less than 0.25% of lead by weight.



LF825Y-FS

Operation

In a flow condition the check valves are open with the pressure between the checks, called the zone, being maintained at least 5 psi lower than the inlet pressure and the relief valve is maintained closed.

Should abnormal conditions arise under no flow or reversal of flow, the differential relief valve opens and discharges to maintain the zone at least 2 psi lower than the supply.

When normal flow resumes, the differential pressure in the zone resumes and the relief valve closes.

NOTICE

Use of the flood sensor does not replace the need to comply with all required instructions, codes, and regulations related to installation, operation, and maintenance of this product, including the need to provide proper drainage in the event of a discharge.

Watts® is not responsible for the failure of alerts due to connectivity or power issues.

NOTICE

The information contained herein is not intended to replace the full product installation and safety information available or the experience of a trained product installer. You are required to thoroughly read all installation instructions and product safety information before beginning the installation of this product.

Inquire with governing authorities for local installation requirements.



A WATTS Brand

Specification

The reduced pressure zone assembly shall consist of two independently operating, spring loaded, "Y" pattern check valves and one hydraulically dependent differential relief valve. The assembly shall automatically reduce the pressure in the "zone" between the check valves to at least 5 psi lower than inlet pressure. Should the differential between the upstream and the zone of the unit drop to 2 psi, the differential relief valve shall open and maintain the proper differential.

Mainline valve body and caps including relief valve body and cover shall be Lead Free* cast copper silicon alloy. Check valve moving member shall be center stem guided. All hydraulic sensing passages shall be internally located within the mainline and relief valve bodies and relief valve cover. Diaphragm to seat area ratio shall be 10:1 minimum. Relief valve shall have a removable seat ring. Check valve and relief valve components shall be constructed so they may be serviced without removing the valve body from the line. All seat discs shall be reversible. Shutoff valves and test cocks shall be full ported ball valves.

The assembly shall be rated to 175 psi (12.1 bar) working pressure and water temperature range from 32°F to 140°F (0°C - 60°C). The Lead Free* Reduced Pressure Zone assemblies shall comply with state codes and standards, where applicable, requiring reduced lead content.

The assembly shall meet the requirements of ASSE Standard 1013; AWWA Standard Code C511; CSA Standard B64.4; and approved by the Foundation for Cross-Connection Control and Hydraulic Research at the University of Southern California.

The assembly shall be FEBCO Series LF825Y, and shall include a sensor on the relief valve for flood detection.

Temperature – Pressure

Maximum working pressure	175 psi (12.1 bar)
Hydrostatic test pressure	350 psi (24.1 bar)
Temperature range	32°F to 140°F (0°C to 60°C)

Materials

Main valve body	Lead Free* cast copper silicon alloy
Relief valve body	Lead Free* cast copper silicon alloy
Elastomers	Nitrile seat discs
Diaphragms	Nitrile, fabric reinforced
Springs	Stainless steel

Model/Option

FS Flood detection sensor

Approvals – Standards

- Approved by the Foundation for Cross-Connection Control and Hydraulic Research at the University of Southern California
- AWWA C511 Conformance



Dimensions – Weight

Call customer service if you need assistance with technical details.

SIZE	DIMENSIONS										WEIGHT	
	A		B*		C		D		E		lb	kg
in.	in.	mm	in.	mm	in.	mm	in.	mm	in.	mm		
¾	12	305	7¾	197	3¼	83	3¼	83	4½	105	11.5	5.2
1	12¾	324	7¾	197	3¼	83	3¼	83	4½	105	12.5	5.7
1½	17	432	10½	267	4½	114	4½	114	5	127	26.5	12.0
2	17¾	451	10½	267	4½	114	4½	114	5	127	29.0	13.0

* B Dimension is less shutoffs

Weights shown are approximate. Dimensions shown are nominal, allowance must be made for normal manufacturing tolerances.

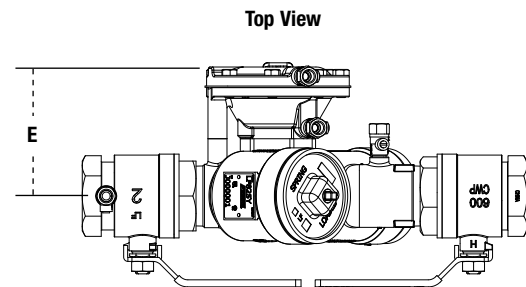
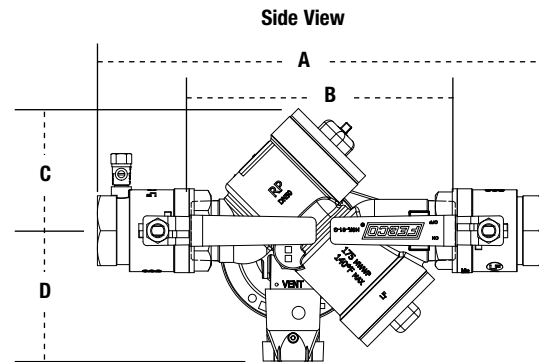

Typical Installation

Reduced pressure zone assemblies should be installed with minimum clearance of 12" between relief valve discharge port and floor or grade. They must be installed where discharge is not objectionable and can be positively drained away. They should be installed where easily accessible for testing and maintenance and must be protected from freezing. Thermal water expansion and/or water hammer downstream of the backflow preventer can cause excessive pressure. Excessive pressure situations should be eliminated to avoid possible damage to the system and assembly.

NOTICE

Refer to local codes for specific installation requirements. Some codes may prohibit vertical installation.

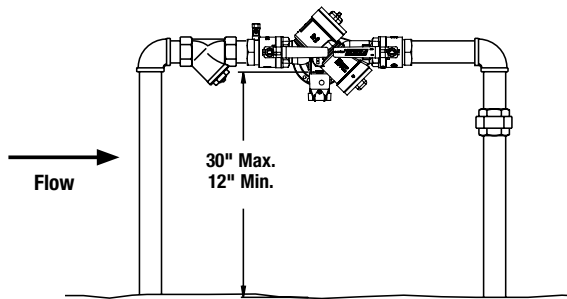

Capacity

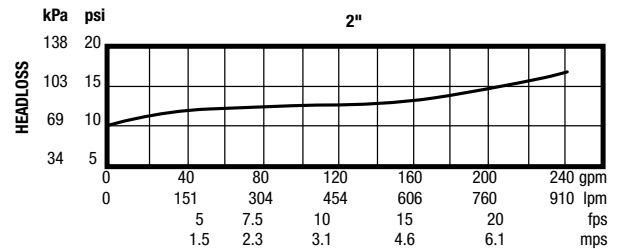
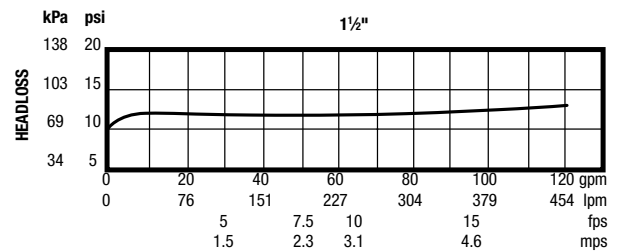
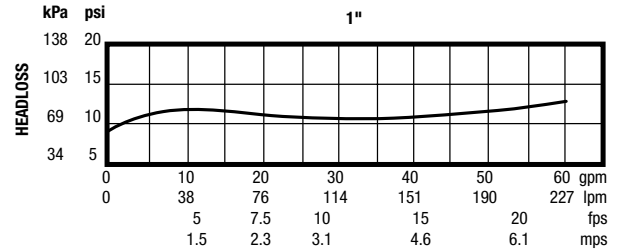
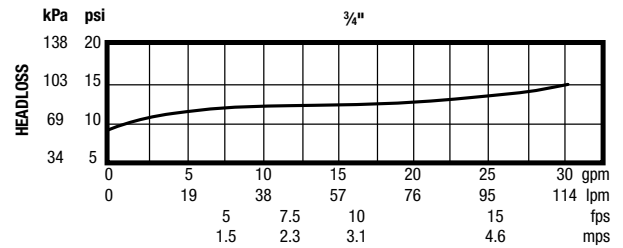

A WATTS Brand

USA: Tel: (800) 767-1234 • Fax: (800) 788-4491 • FEBCOonline.com
 Canada: Tel: (905) 332-4090 • Fax: (905) 332-7068 • FEBCOonline.ca
 Latin America: (52) 81-1001-8600 • Fax: (52) 81-8000-7091 • FEBCOonline.com

