

Job Name _____

Contractor _____

Job Location _____

Approval _____

Engineer _____

Contractor's P.O. No. _____

Approval _____

Representative _____

LEAD FREE***LFF113FP****Wireless Smart Flood Protection Shut Down Valve with SentryPlus Alert™ Technology**

- Installed upstream of Reduced Pressure Zone Backflow Preventer
- Normally Open Valve - Closes when continuous discharge from RPZ Relief Valve is sensed or by engaging Solenoid By-Pass
- Valve must be manually reset
- Position Indicator provides local visual indication of valve closure
- Relay Box provided Valve mounted. Can be remote mounted in field.
- Can be connected to a Building Management System (BMS)
- Flood Sensor, SentryPlus Alert™ Control Box, and Cellular Gateway are Field Installed
- Detects continuous water discharge from RPZ Backflow Preventer and shuts down the valve in case of abnormality
- SentryPlus Alert™ wirelessly alerts user via text, call or email

Materials

Body & Cover:	Ductile Iron ASTM A536
Coating:	NSF Listed Fusion Bonded Epoxy Lined and Coated
Trim:	316 Stainless Steel
Elastomers:	Buna-N (Standard) EPDM (Optional) Viton® (Optional)
Stem, Nut & Spring:	Stainless Steel
Anti-Scale:	Xylan™ Coated Stem (Standard)
Tubing & Fittings:	Copper / Brass (Standard) Stainless Steel (Optional)
Solenoid	Stainless Steel-NEMA 4 General Purpose 110-VAC

NOTICE

Use of the Watts Smart Flood Protection Shut Down Valve with SentryPlus Alert™ Technology does not replace the need to comply with all required instructions, codes, and regulations related to the installation, operation, and maintenance of an RPZ backflow preventer, including the need to provide proper drainage in the event of a discharge.

Watts is not responsible for the failure of alerts due to connectivity or power issues.

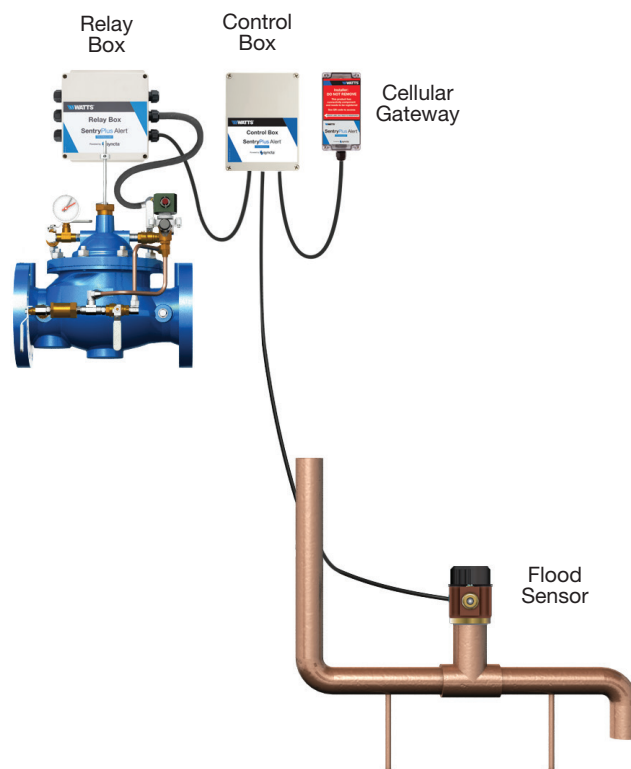
**OPERATING PRESSURE**

Threaded = 400 psig
150 Flanged = 250 psig
300 Flanged = 400 psig
Grooved End = 400 psig

OPERATING TEMPERATURE

Buna-N: 160°F Maximum
EPDM: 300°F Maximum
Viton: 250°F Maximum

NOTICE

The information contained herein is not intended to replace the full product installation and safety information available or the experience of a trained product installer. You are required to thoroughly read all installation instructions and product safety information before beginning the installation of this product.

*The wetted surface of this product contacted by consumable water contains less than 0.25% of lead by weight.

Viton® is a registered trademark of DuPont Dow Elastomers.

Xylan™ is a trademark of Whitford Corporation.

Watts product specifications in U.S. customary units and metric are approximate and are provided for reference only. For precise measurements, please contact Watts Technical Service. Watts reserves the right to change or modify product design, construction, specifications, or materials without prior notice and without incurring any obligation to make such changes and modifications on Watts products previously or subsequently sold.

Typical Installation

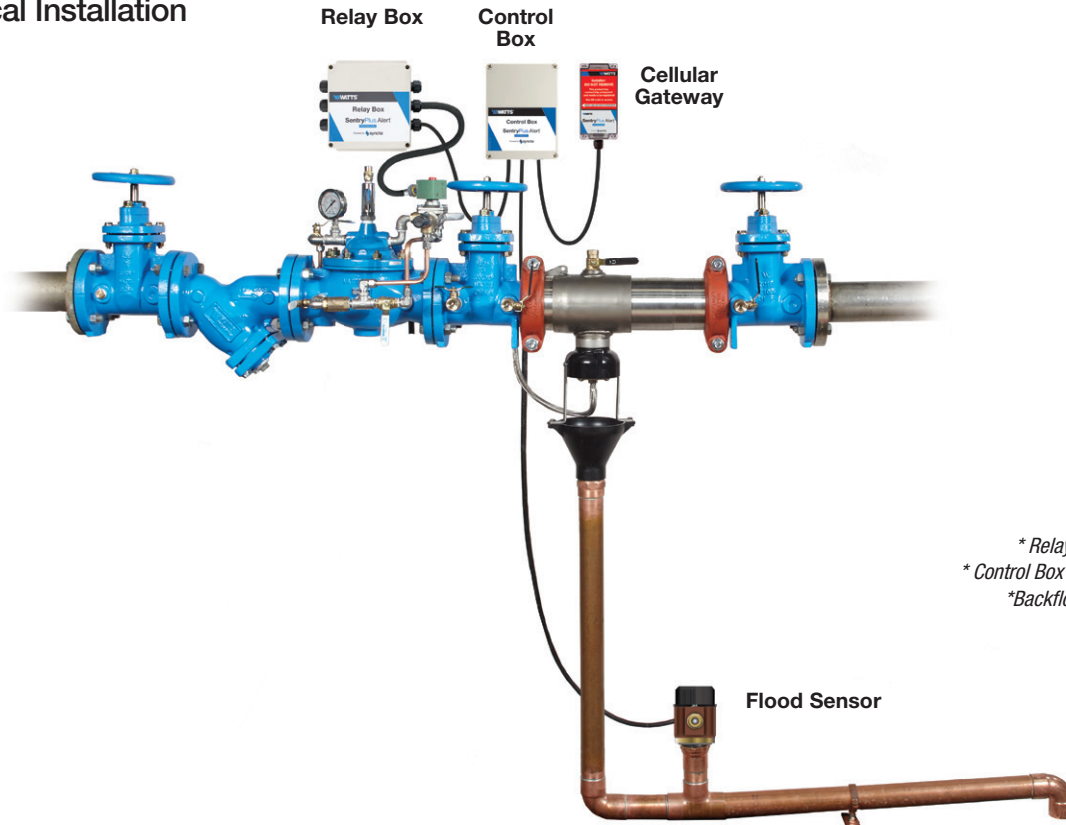

* Relay Box Ships Valve Mounted
 * Control Box and Cellular Gateway Ships Loose
 * Backflow shown is Watts 957-OSY

Schematic

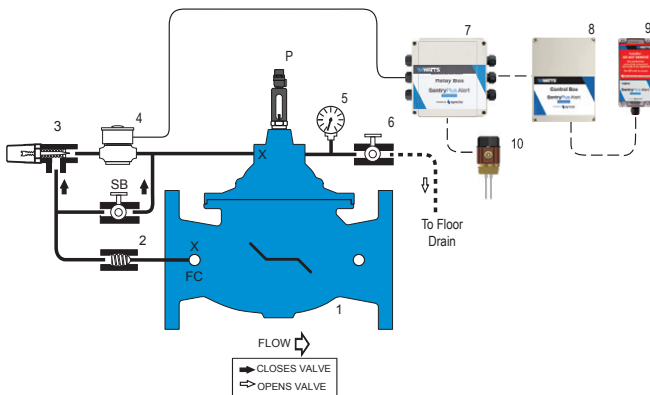

Operation

The Watts Flood Protection Shutdown Valve system helps to protect against catastrophic property damage that can occur due to Relief Valve discharge and/or a blocked or overwhelmed floor drain during normal relief valve operation. Typical conditions which can cause continuous relief valve discharge are:

- Fouled First Check Seat due to dirt, debris or rocks
- Failed First Check Spring
- Clogged or blocked Relief Valve Sensing Line
- Relief Valve Diaphragm failure

The Watts LFF113FP Flood Protection Shutdown Valve is a normally open valve designed to be installed upstream of a Reduced Pressure Zone (RPZ) Backflow Prevention device. It is normally open and closes when continuous relief valve discharge through the drain pipe is sensed by the Flood Sensor, energizing the Relay Box and Solenoid Pilot. The valve is equipped with a Solenoid By-Pass valve (normally closed) which manually closes the Main Valve when engaged. The remote mounted Control Box is equipped with an adjustable time delay to avoid valve closure due to intermittent or nuisance relief valve discharge. The Position Indicator provides local, visual indication of valve closure and is useful during valve start-up and troubleshooting. The valve remains closed and cannot re-open if flow stops or electrical service is interrupted, and must be manually reset after the RPZ is diagnosed and/or repaired.

The valve comes complete with the valve mounted Relay Box, Control Box with adjustable time delay, pre-wired Solenoid Valve, Manual Reset with Pressure Gauge, Position Indicator and Flood Sensor (field installed). The SentryPlus Alert™ Cellular Gateway ships loose with 6 feet of interconnecting cable and will be field mounted.

Standard Components

- 1 - Main Valve (Single Chamber)
 - 2 - Check Valve
 - 3 - Adjustable Closing Speed
 - 4 - 2-Way Solenoid
 - 5 - Pressure Gauge
 - 6 - Manual Reset Ball Valve
 - 7 - Relay Box
 - 8 - Control Box
 - 9 - Cellular Gateway
 - 10 - Flood Sensor
- P - Position Indicator
 SB - Solenoid By-Pass
 X - Isolation Cocks
 FC - Flow Clean Strainer

Flow Data

VALVE SIZE - INCHES		1 1/4	1 1/2	2	2 1/2	3	4	6	8	10
SUGGESTED	Maximum Continuous Flow Rate Gpm (Water)	93	125	208	300	460	800	1800	3100	5000
	Maximum Intermittent Flow Rate Gpm (Water)	115	158	260	370	570	1000	2300	3900	6250
	Minimum Flow Rate Gpm (Water)	3	5	6	9	15	16	17	25	55
C _v	Factor GPM (Globe)	29	34	55	75	125	220	460	775	1215
	Factor GPM (Angle)	39	53	66	99	170	280	650	1100	1530

- Maximum continuous flow based on velocity of 20 ft. per second.
- Maximum intermittent flow based on velocity of 25 ft. per second.
- Minimum flow rates based on a 20-40 psi pressure drop.
- The C_v Factor of a value is the flow rate in US GPM at 60°F that will cause a 1psi drop in pressure.
- C_v factor can be used in the following equations to determine Flow (Q) and Pressure Drop (ΔP):

$$Q \text{ (Flow)} = C_v \sqrt{\Delta P} \quad \Delta P \text{ (Pressure Drop)} = (Q/C_v)^2$$
- The C_v factors stated are based upon a fully open valve.
- Many factors should be considered in sizing control valves including inlet pressure, outlet pressure and flow rates.
- For sizing questions including cavitation analysis consult Watts with system details.

Headloss

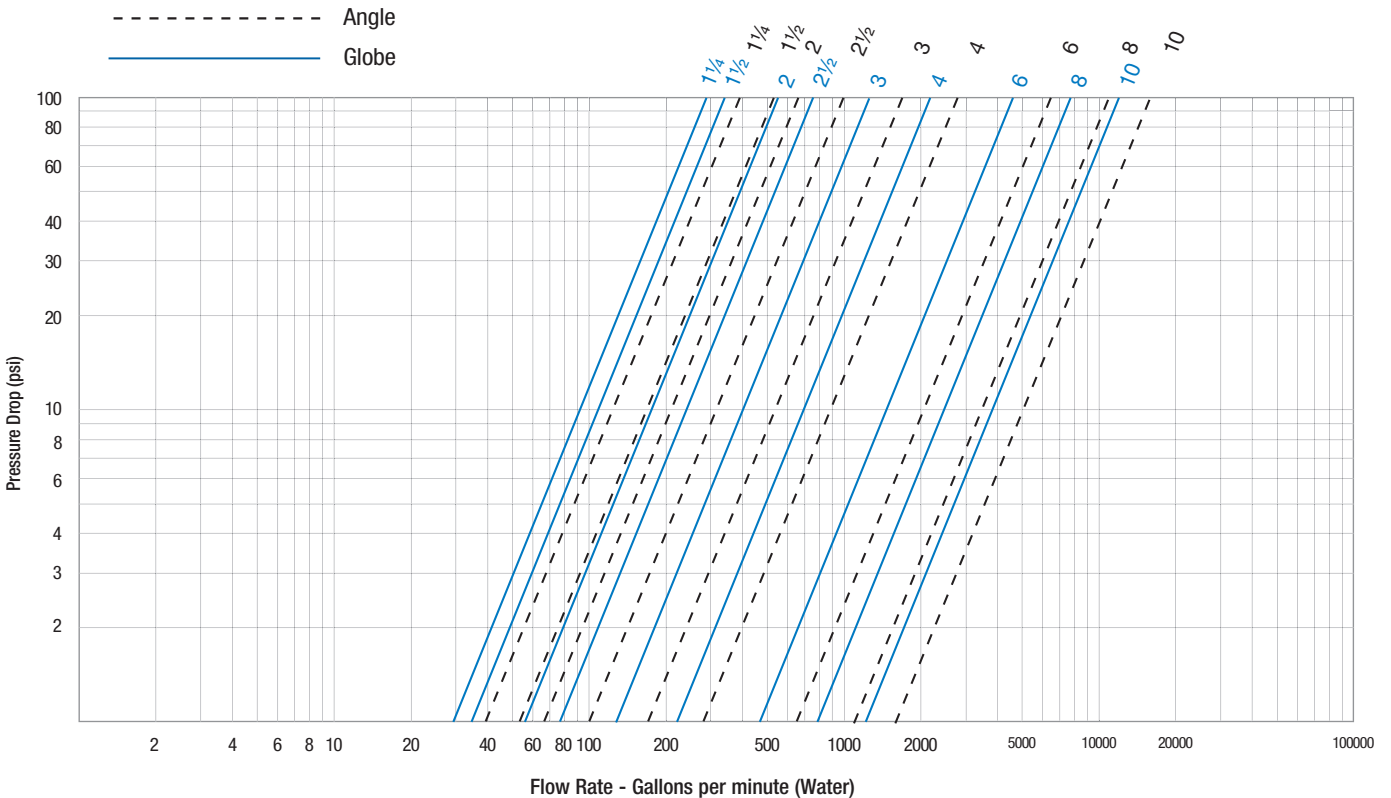

The C_v Factor of a value is the flow rate in US GPM at 60° F that will cause a 1 psi drop in pressure. The factors stated are based upon a fully open valve. C_v factor can be used in the following equations to determine Flow (Q) and Pressure Drop (Δ P):

$$Q \text{ (Flow)} = C_v \sqrt{\Delta P} \quad \Delta P \text{ (Pressure Drop)} = (Q/C_v)^2$$

Typical Main Valve

(Threaded and Flanged design)

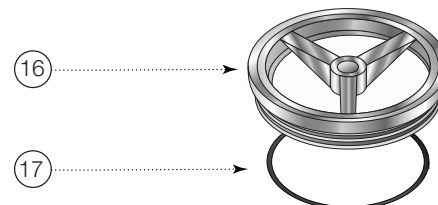
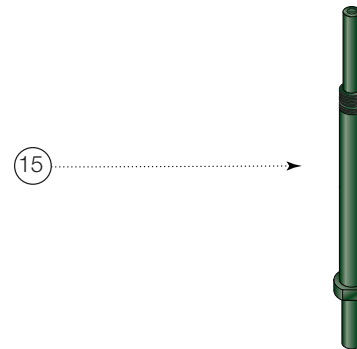
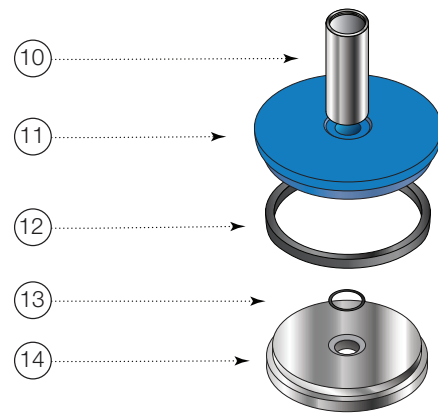
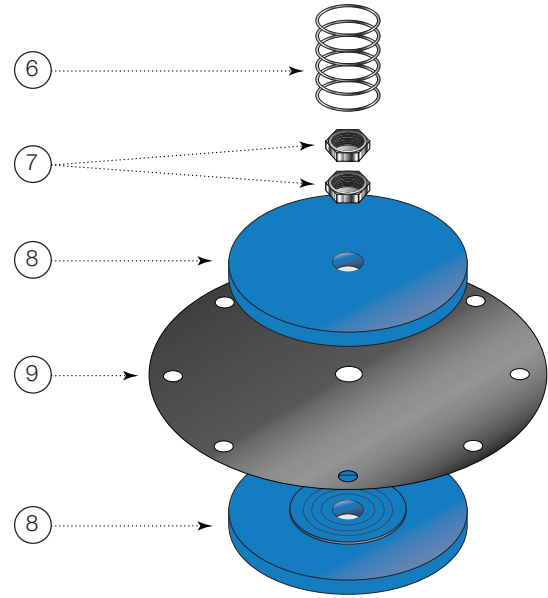
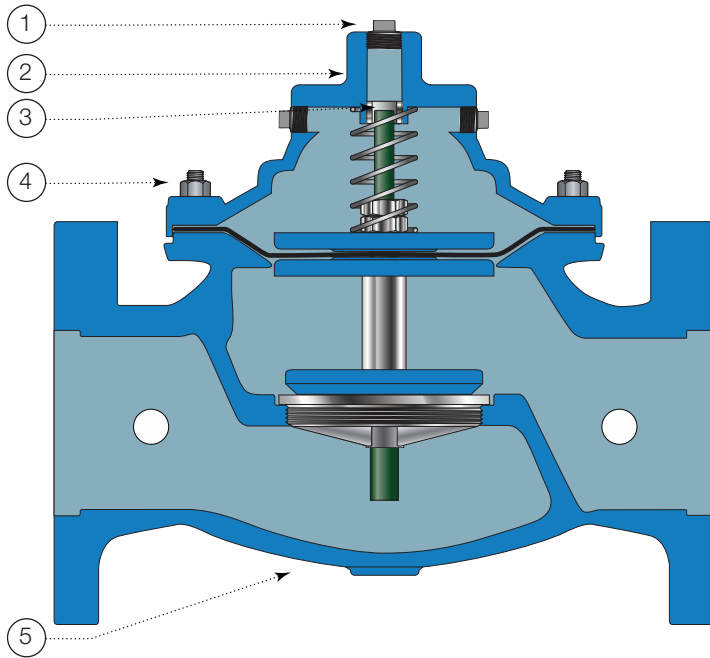

ITEM	DESCRIPTION	MATERIAL
1	Pipe Plug	Lead Free Brass
2	Cover	ASTM A536 65-45-12 Epoxy Coated Ductile Iron
3	Cover Bearing	ASTM A276 304 Stainless Steel
4	Stud with Cover Nut and Washer	ASTM A570 Gr.33 Zinc Plated Steel
5	Body	ASTM A536 65-45-12 Epoxy Coated Ductile Iron
6	Spring	ASTM A276 302 Stainless Steel
7	Stem Nut	ASTM A276 304 Stainless Steel
8	Diaphragm Washer	ASTM A536 65-45-12 Epoxy Coated Ductile Iron
9	Diaphragm*	Buna-N (Nitrile)
10	Spacer	ASTM A276 304 Stainless Steel
11	Quad Seal Retainer	ASTM A536 65-45-12 Epoxy Coated Ductile Iron
12	Quad Seal*	Buna-N (Nitrile)
13	O-Ring*	Buna-N (Nitrile)
14	Quad Seal Plate	ASTM A743 CF8M (316) Stainless Steel
15	Shaft / Stem	ASTM A276 304 Stainless Steel -Xylan coated
16	Seat Ring	ASTM A743 CF8M (316) Stainless Steel
17	Seat Gasket*	Buna-N (Nitrile)

* Contained in Main Valve Repair Kit

NOTICE

Installation: If unit is installed in any orientation other than horizontal (cover up) OR extreme space constraints exist, consult customer service prior to or at the time of order.

Dimensions

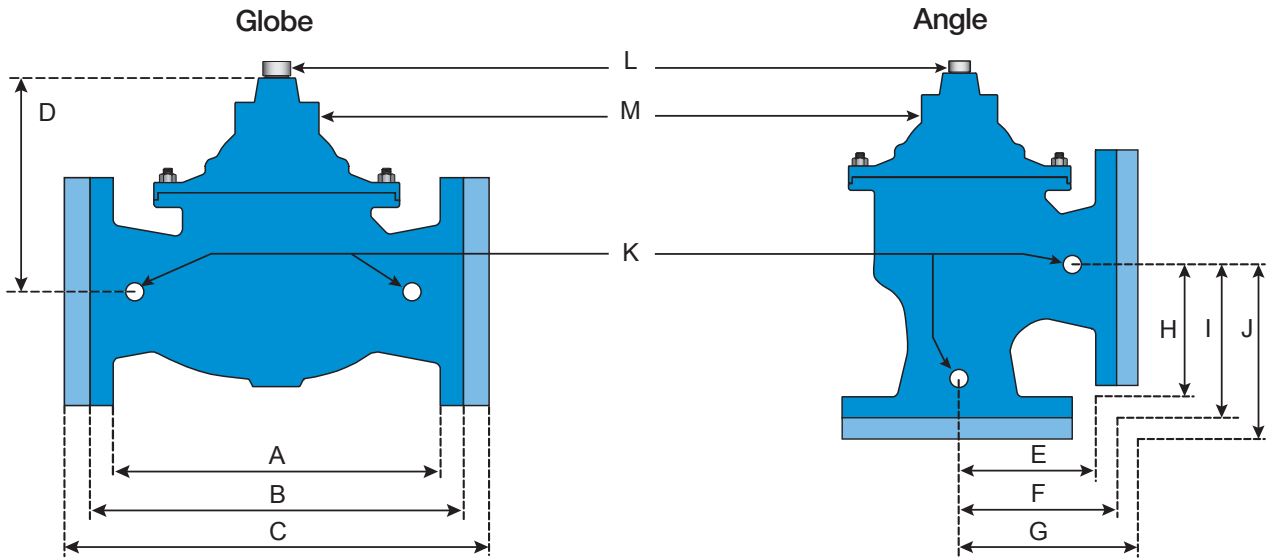

Globe Thread		Globe 150#		Globe 300#		Cover To Center		Angle Thread		Angle 150#		Angle 300#		Angle Thread		Angle 150#		Angle 300#		Port Size NPT	Port Size NPT	Port Size NPT	Shipping Weights*				
A		B		C		D		E		F		G		H		I		J		K	L	M					
in.	mm	in.	mm	in.	mm	in.	mm	in.	mm	in.	mm	in.	mm	in.	mm	in.	mm	in.	mm	in.	mm	in.	mm	in.	mm	lb	kg
1 1/4	7 1/4	184						3 1/2	89	3 1/4	83					1 7/8	48					1/4	1/2	1/8	15	7	
1 1/2	7 1/4	184	8 1/2	216				3 1/2	89	3 1/4	83	4	102			1 7/8	48	4	102			1/4	1/2	1/8	15	7	
2	9 3/8	238	9 3/8	238	10	254	4 15/16	125	4	102	4	102	4 1/4	108	4	102	4	102	4 1/4	108	1/2	1/2	1/4	35	16		
2 1/2	11	279	11	279			7	178	5 1/2	140	5 1/2	140	5 13/16	148	4	102	4	102	4 5/16	110	1/2	1/2	3/8	65	30		
3	10 1/2	267	12	305	13 1/4	337	7	178	5 1/4	133	5 3/4	146	6 1/8	156	5 1/4	133	5 3/4	146	6 1/8	156	1/2	1/2	3/8	95	43		
4			15	381	15 5/8	397	8 5/8	219			6 3/4	171	7 1/8	181			6 3/4	171	7 1/8	181	1/2	1/2	3/8	190	86		
6			20	508	21	533	11 3/4	298			8 1/2	216	8 7/8	225			8 1/2	216	8 7/8	225	1/2	1/2	1/2	320	145		
8			25 3/8	645	26 3/8	670	15 3/4	400			11	279	11 1/2	292			11	279	11 1/2	292	1/2	1	1/2	650	295		
10			29 3/4	756	31 1/8	791	17	430			14 7/8	378	15 9/16	395			8 5/8	219	9 5/16	237	1	1		940	426		

Grooved End Dimensions*

VALVE SIZE	GLOBE GROOVED		COVER TO CENTER		ANGLE GROOVED		ANGLE GROOVED		PORT SIZE (NPT)		PORT SIZE (NPT)		SHIPPING WEIGHTS*	
	A	B	C	D	E	F	lb	kg						
in.	in.	mm	in.	mm	in.	mm	in.	mm	in.	in.	lb	kg	lb	kg
1 1/4	8 1/2	216	5 1/2	140	4 1/4	108	3 1/4	83	3/8	1/4	25	11		
1 1/2	8 1/2	216	5 1/2	140	4 1/4	108	3 1/4	83	3/8	1/4	25	11		
2	9	229	6 1/2	165	4 3/4	121	3 1/4	83	3/8	1/2	40	18		
2 1/2	11	279	7 1/2	191	5 1/2	140	4	102	1/2	1/2	65	29		
3	12 1/2	318	8 1/4	210	6	152	4 1/4	108	1/2	1/2	95	43		
4	15	381	10 5/8	270	7 1/2	191	5	127	3/4	3/4	190	86		
6	20	508	13 3/8	340					3/4	3/4	320	145		
8	25 3/8	645	16	406					1	1	650	295		

*Available as configured item. Contact customer service for more details.

	1 1/4	1 1/2	2	2 1/2	3	4	6	8	10
fl.oz.	4	4	4	10	10	22	70		
U.S. Gal								1 1/4	2 1/2

Valve Travel

VALVE SIZE - INCHES	1 1/4	1 1/2	2	2 1/2	3	4	6	8	10
Travel - Inches	3/8	3/8	1/2	5/8	3/4	1	1 1/2	2	2 1/2

Control Box

The Control Box is equipped with an adjustable time delay.

The valve is normally open and closes when continuous relief valve discharge through the drain pipe is sensed by the Flood Sensor.

The Control Box is equipped with an adjustable time delay to avoid valve closure due to intermittent or nuisance relief valve discharge. The time delay is adjustable from 0 to 120 seconds.

Time delay can be adjusted by pressing the + or - buttons in the Control Box.

The Control Box also features terminals to connect to a Building Management System or alarm.

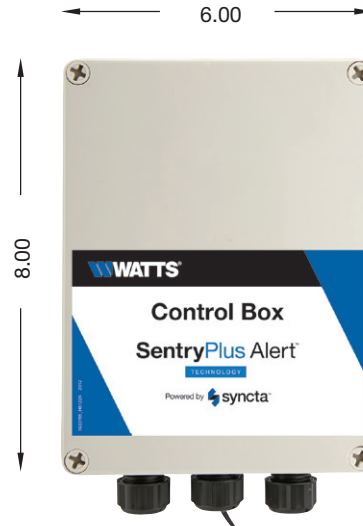

Cellular Gateway

Watts Cellular Gateway is hardwired to Control Box and are in constant communication with each other. Cellular Gateway communicates via cellular network with Watts Syncta® Cloud IoT platform. In-case of an abnormal continuous discharge from the Relief valve, the unit wirelessly notifies user alerting them of the fault condition.

Cellular Gateway is a remote mounted, electrically powered and receives power via connection to the Control Box. It can be mounted up to 100ft away from the Control Box.



Flood Sensor

The Flood Sensor is installed in the discharge piping from the RPZ relief valve. If the Flood Sensor detects water in the discharge piping, it will signal the Control Box to send wireless alerts and/or close the LFF113FP valve.

Front View

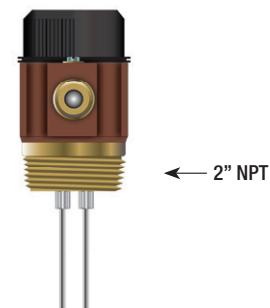

Relay Box

The Relay Box contains the relay used to operate the LFF113FP Solenoid to close the valve. It receives the signal from the Control Box, and is wired directly to the Solenoid.

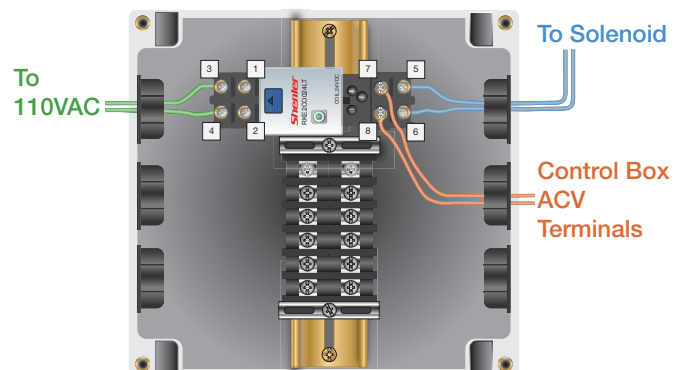

Universal Upgrade Kit

(Upgrade existing installations of LFF113FP and RPZ Backflow Preventers to Connected Assemblies)

Universal Upgrade Kit is an ideal solution to upgrade existing LFF113FP ACV and/or Backflow RPZ installations to Smart Connected assemblies. The upgrade can be done in-line without any removal of existing components already installed.

EDP CODE	DESCRIPTION
0113209	For existing RPZ/RPDA backflow preventers
0113210	For existing LFF113FP Flood Protection ACV (in conjunction with 0113209)

The Kit consists of following:

EDP 0113209

- Control Box
- Cellular Gateway
- Flood Sensor
- 2" Tee (PVC) with NPTF threaded end connections
(To mount Flood Sensor)

EDP 0113210*

- Relay Box for LFF113FP ACV solenoid

*Relay Box will not fit on existing valve mounting brackets used for the JB113 Junction Box. Contact Watts Customer Service for appropriate valve mounting bracket, or wall mount Relay Box.

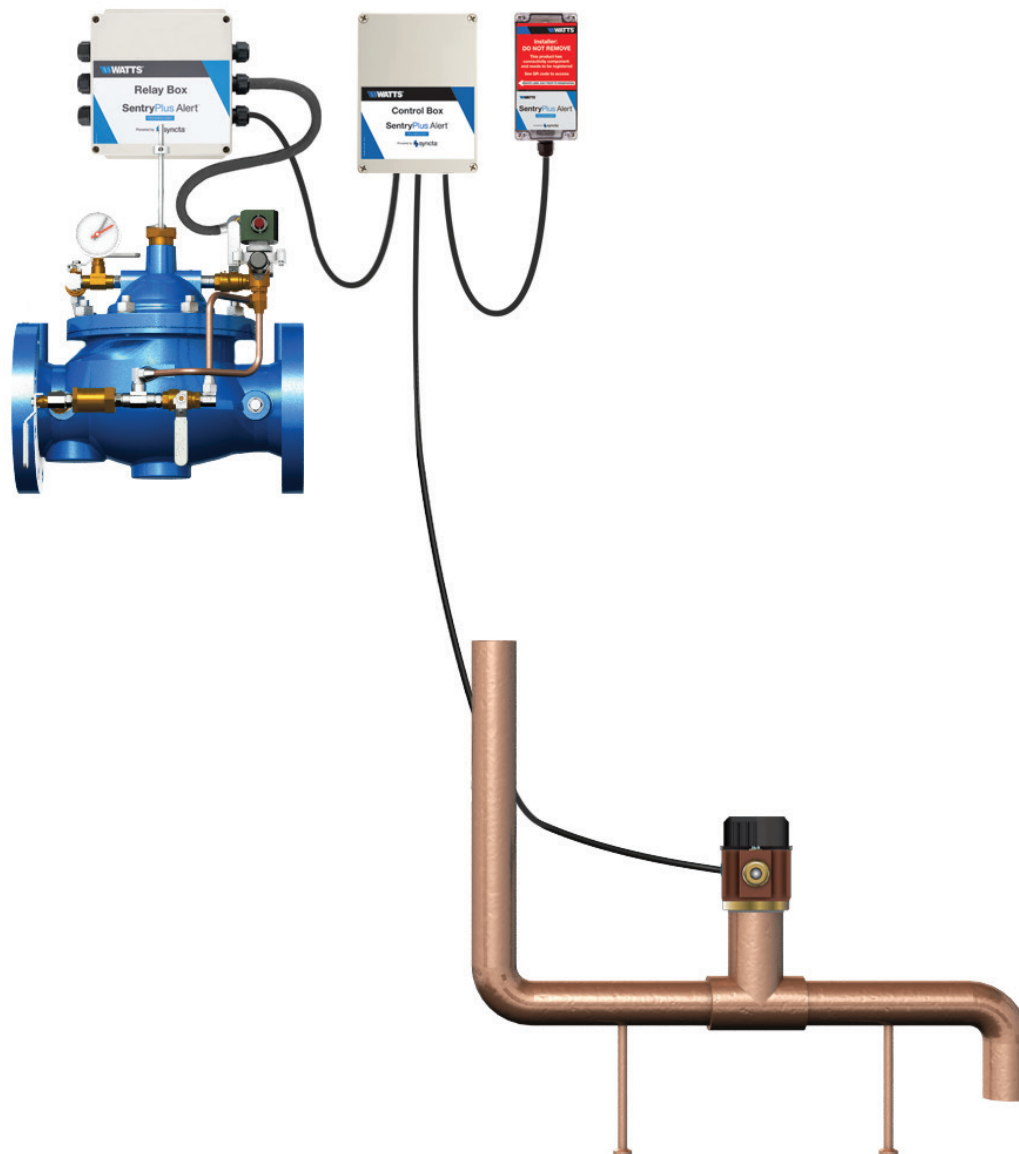

Specifications

The Flood Protection Shutdown Valve shall be a normally open Diaphragm Valve installed upstream of the Reduced Pressure Zone Backflow Assembly, and automatically close if the RPZ relief valve begins to discharge. A Time Delay supplied in the Control Box shall prevent the valve from closing on intermittent discharges from the RPZ relief valve. If continuous Relief Valve discharge occurs, the Flood Sensor installed horizontally in the RPZ Relief Valve discharge piping shall send a signal to the Control box, energizing the Relay box and Solenoid to close the main valve. Once closed the Flood Protection Shutdown Valve must be manually reset.

The Control Box connects to Cellular Gateway for wireless communication alerting the user via text, phone or email. This communication is via cellular network using Watts Syncta Cloud IoT platform. Wireless node is a remote mounted unit. It can be mounted up to 100ft away from the Control Box. Additionally, an extra set of Remote Trip Indication terminals allow users to get remote alarms at their Building Management System (BMS) / PLC controller in the Control Room.

The Relay Box shall be valve mounted with the Relay pre wired to the ACV solenoid. The Flood Sensor shall be provided with the valve package and shall be field installed in a horizontal position in the RPZ Relief Valve discharge piping. Vertical installation of the Flood Sensor shall not be acceptable. The valve shall be equipped with a Position Indicator to provide local visual indication of valve closure. The Position Indicator shall be a stainless steel indicating rod which follows main valve stem movement as seen through a cylindrical Pyrex sight tube.

The Reduced Pressure Zone Backflow Assembly, Flood Protection Shutdown Valve, Relay Box, Control Box, and Flood Sensor shall be provided by the same manufacturer and be covered by a single warranty policy.

The main valve shall be a hydraulically operated, single diaphragm actuated, globe or angle pattern valve. Y-pattern valves shall not be permitted. The valve shall contain a disc and diaphragm assembly that forms a sealed chamber below the valve cover, separating operating pressure from line pressure. The diaphragm shall be constructed of nylon reinforced Buna-N, and shall not seal directly against the valve seat and shall be fully supported by the valve body and cover. Rolling diaphragm construction will not be allowed and there shall be no pistons operating the main valve or any pilot controls.

The main valve body and cover shall be Ductile Iron ASTM A536, and all internal cast components shall be Ductile Iron or CF8M (316) Stainless Steel. All Ductile Iron components, including the body and cover, shall be lined and coated with an NSF 61 Certified Epoxy Coating applied by the electrostatic heat fusion process. All main valve throttling components (valve seat and disc guide) shall be Stainless Steel. The valve body and cover must be machined with a 360-degree locating lip to assure proper alignment.

The disc and diaphragm assembly shall contain a Buna-N synthetic rubber disc with a rectangular cross-section that is securely retained on 3-1/2 sides by a disc retainer and disc guide. Diaphragm assemblies utilizing bolts or cap screws for component retention will not be permitted. Direction of flow through the valve shall be the under-the-disc design.

The exposed portion of the seat disc shall contact the valve seat and seal drip-tight. The disc and diaphragm assembly must be guided by two separate bearings, one installed in the valve cover and one concentrically located within the valve seat, to avoid deflection and assure positive disc-to-seat contact. Center guided valves will not be permitted. The main valve spring shall be the manufacturer's heavy or extra heavy spring design. All necessary repairs shall be made from the top of the valve while the body remains in line.

The Pilot Control System shall contain a Flo-Clean Strainer, NEMA 4, 120 VAC 60HZ 2-Way Solenoid with Manual Operator, Manual Reset Ball Valve, Pressure Gauge, Visual Position Indicator, Relay Box, Control Box, and Isolation Ball Valves on all body connections. The Relay Box shall be valve mounted and the Control Box and Flood Sensor shall be field installed.

The valve shall be Watts 113FP (globe) or 1113FP (angle) Wireless Smart Flood Protection Shutdown Valve.

Series 009, 909, 919, 957 and 994

Reduced Pressure Zone Assemblies

Relief Valve Discharge Rates

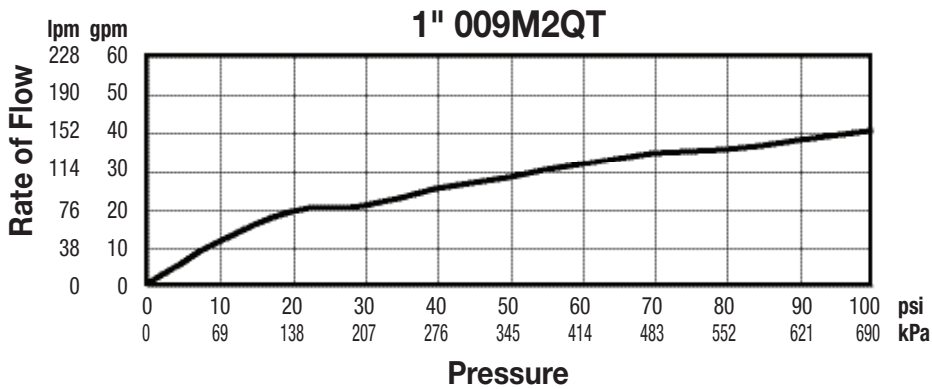
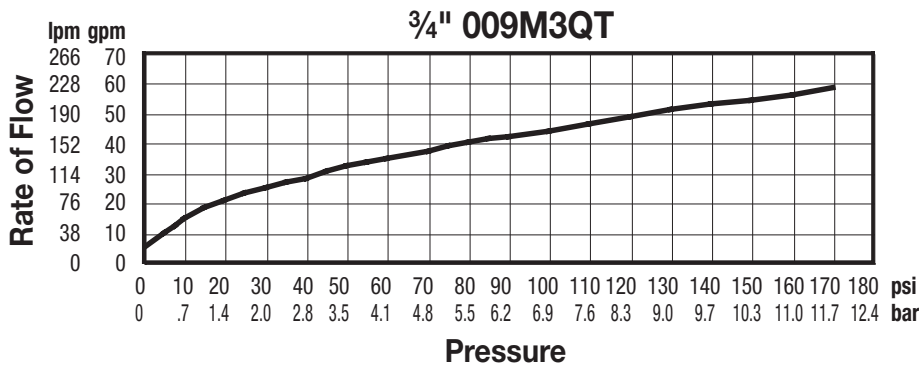
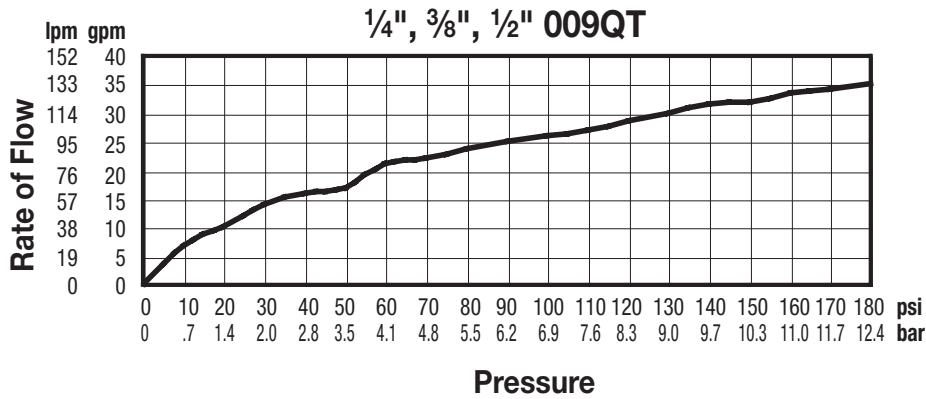

Note: These curves represent catastrophic or worst case discharge rates. These curves were developed by pressurizing the outlet of the backflow preventer with the second check valve's internals removed from the body.

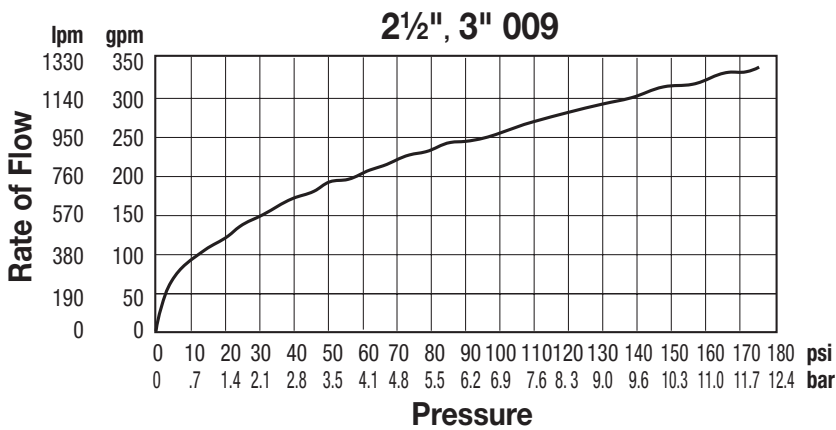
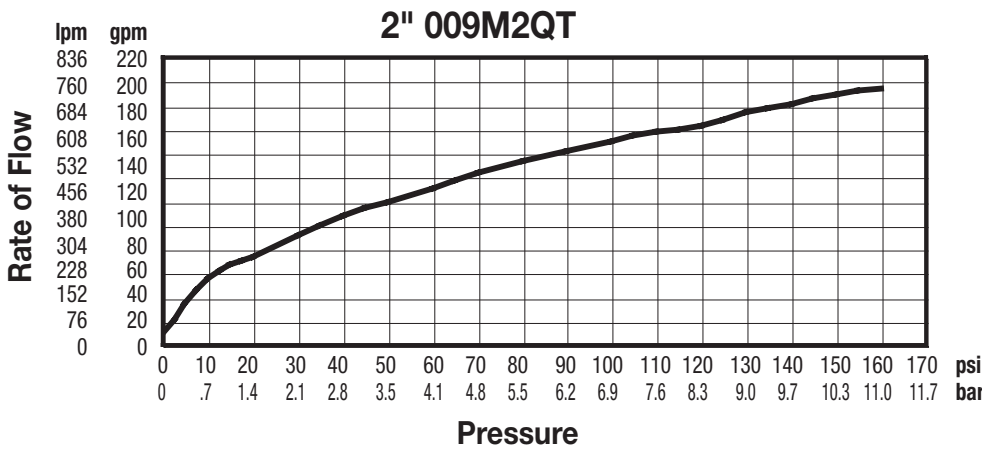
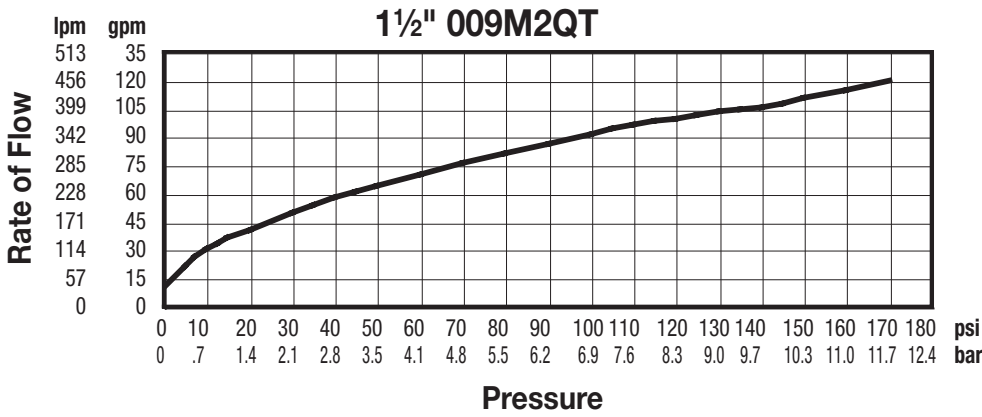
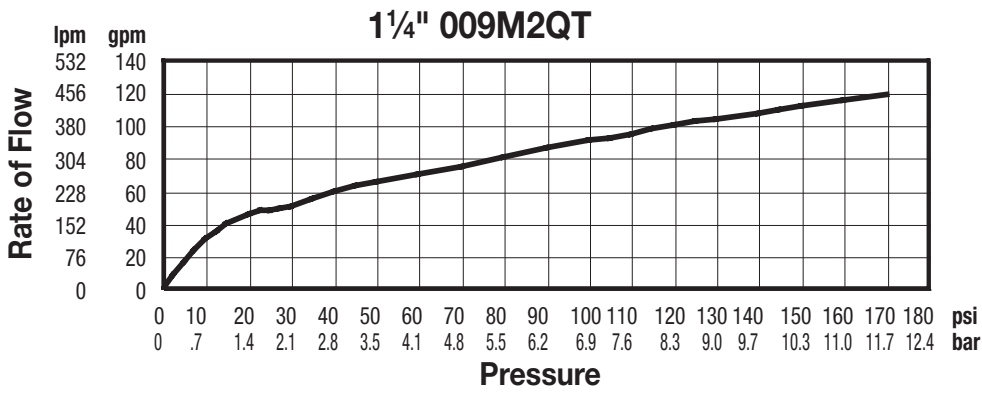

Note: These curves represent catastrophic or worst case discharge rates. These curves were developed by pressurizing the outlet of the backflow preventer with the second check valve's internals removed from the body.

3/4", 1" 909

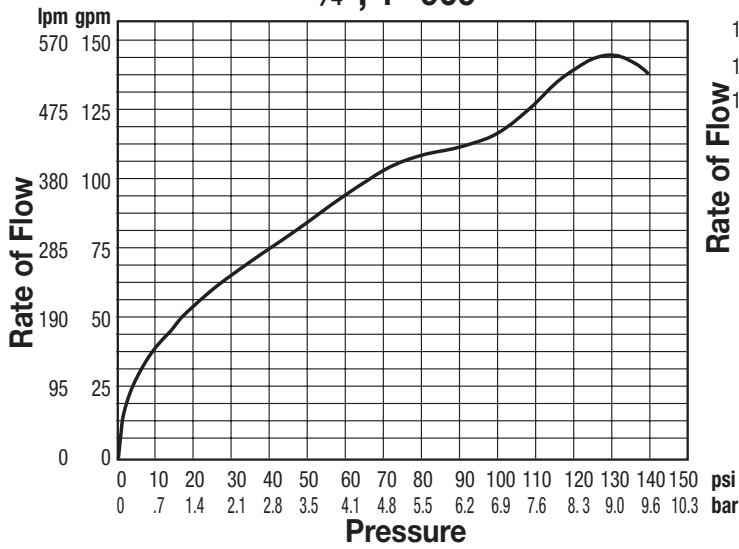

1 1/4", 1 1/2", 2" 909

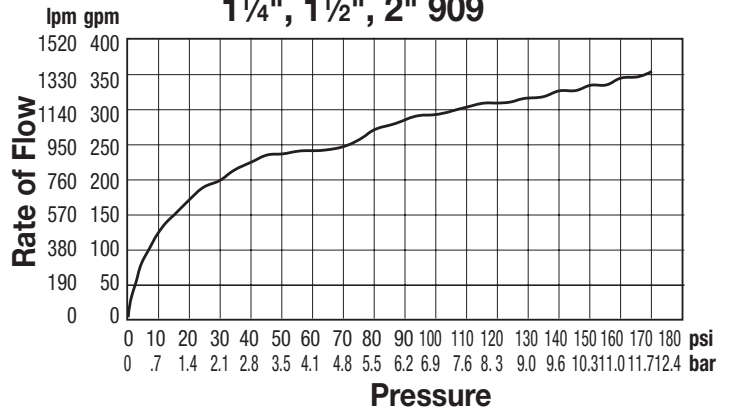

2 1/2" - 3" 909

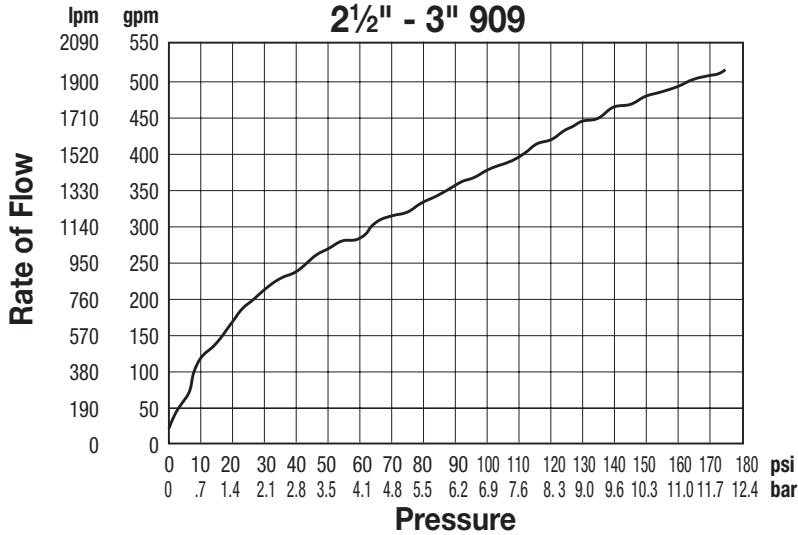

4", 6", 8", 10" 909

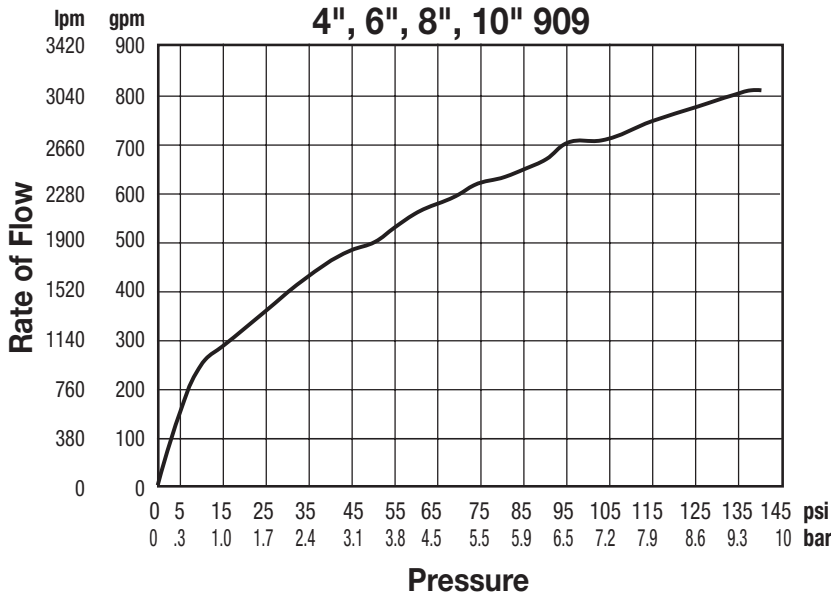

Note: These curves represent catastrophic or worst case discharge rates. These curves were developed by pressurizing the outlet of the backflow preventer with the second check valve's internals removed from the body.

1" 919 RV
Capacity w/Second Check Removed

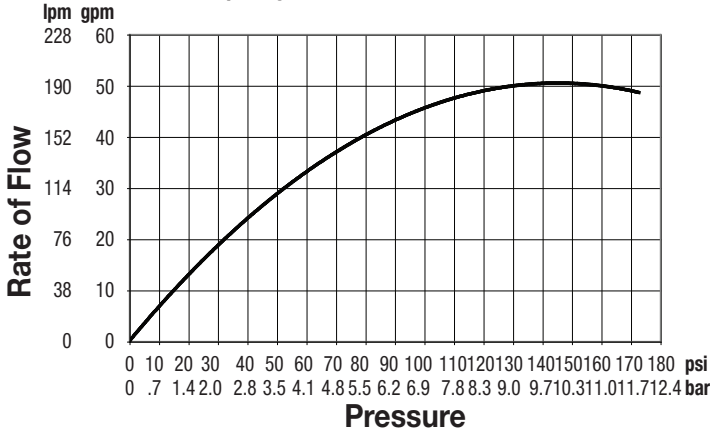

2" 919 QT
Backpressure w/Second Check Poppet & Spring Removed

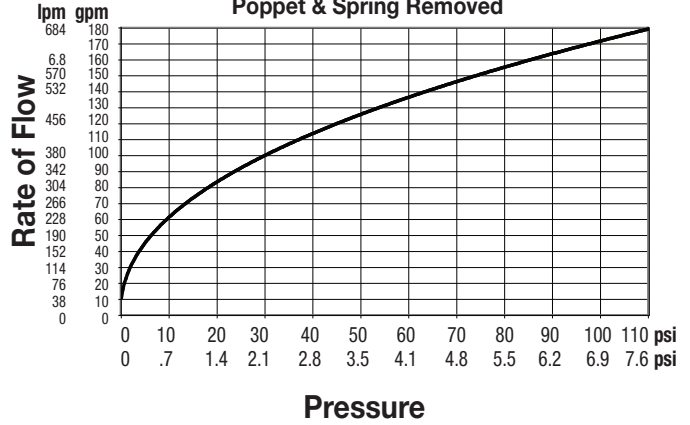

2½" - 10" 994

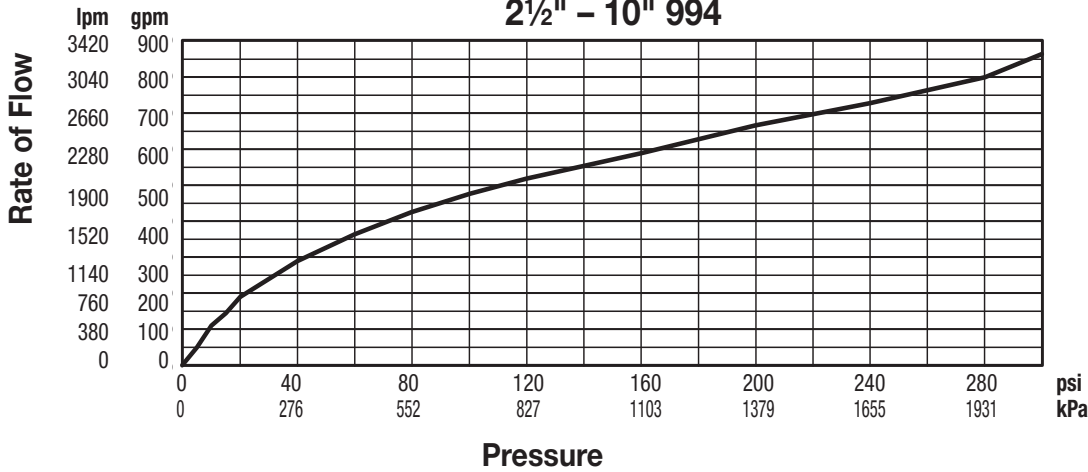

2½" - 10" 957

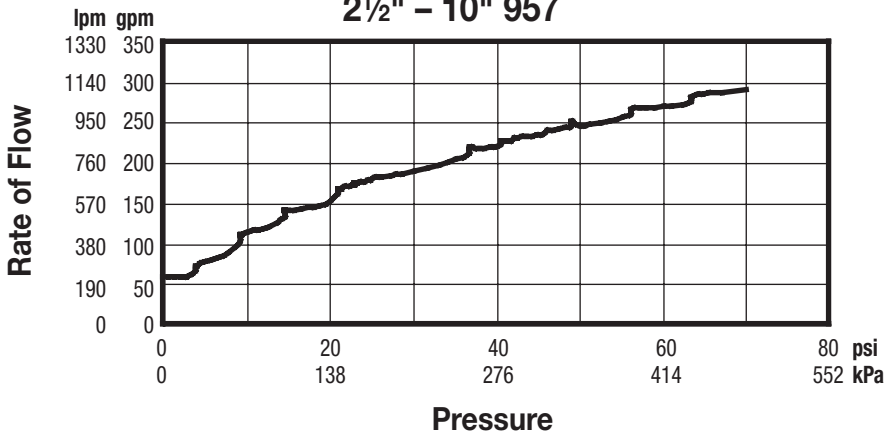

Note: These curves represent catastrophic or worst case discharge rates. These curves were developed by pressurizing the outlet of the backflow preventer with the second check valve's internals removed from the body.

Typical Flow Rates as sized by floor drain manufacturers		Drain Size
gpm	lpm	
55	209	2
112	426	3
170	646	4
350	1330	5

