

Price List

WaterPEX® Plumbing Products



Effective March 31, 2025

All prices supersede previous issues, are temporary and subject to change without notice.

Electronic is Green!

For the latest WaterPEX pricing information in electronic format, visit our Data Exchange at:

<http://www.wattswater.com/dataexchange>

- Download product and list price data in .csv, .pdf, .tsv, .xls and .xml formats
- Easy access to list price data for business systems
- Sign up for e-mail alerts when data is updated
- Access other Watts Water Technologies brands pricing data

Table Of Contents

SECTION	ITEM TYPE	PAGE	SECTION	ITEM TYPE	PAGE
Terms and Conditions		2	PEX Fittings - Poly Alloy		19
Matrix		3	CrimpRing™ Couplings	WP15P	19
Codes, Standards, Approvals and Technical Data		3	CrimpRing™ Elbows	WP19P	19
WaterPEX® Tubing		4	CrimpRing™ x MPT Adapters	WP12P	20
Red, Blue and White Coils	WPTC	4	CrimpRing™ x MPT Elbows	WP20P	20
Red, Blue and White 20' Sticks	WPTS	5	CrimpRing™ Tees	WP18P	21
10' Sticks – Fast Packs	WPPF	5	Swivel Couplings	WP25P, WP26P	22
Stud Reel with Tubing	WPSR	5	Test Plugs	WP27P	22
Stops and Valves		6	Pipe Support and Accessories	Mounting	23
Full-Port Ball Valves	LFWPABV	6	Stubout Brackets and Elbows		23
Full-Port Ball Valves with Drain	LFWPABVD	6	PEX Stubout Brackets and Grommets -		
Copper Manifolds		7	Galvanized	WPSB, WPIG	23
Closed End x 1" Swedged End	LFWPCM1	7	Copper Stubout Brackets and Elbows	WPSB	24
Closed End x 3/4" CrimpRing™ End	LFWPCM2	8	Bend Supports	WPBS	24
3/4" CrimpRing™ End x 3/4"			WaterPEX® Fasteners		25
CrimpRing™ End	LFWPCM3	9	SnapClip™	WPSC	25
CustomCut™	LFWPCM5	10	PEX Manifold Bracket	WPUMB	26
PEX Valves and Accessories		11	PEX Installation Tools & Accessories		27
Stops and Valves	LFWPSV	11	WaterPEX® Tools		27
1/4-Turn Chrome Stops		11	Basic Tubing Cutter	WPTC	27
PEX Stops		1	Professional Tubing Cutter	WPTC	27
In-line Crimp x Crimp Full Port Ball Valves		12	Ratcheting Cinch Tool	WPCCT-6	27
CrimpRing™ and CinchClamps™		13	CinchClamp™ Tool	WPCCT	28
Stainless Steel CinchClamps™	WP9S	13	RingMaster™ Crimping Tools	WPRM	28
Close Ear (CE) CinchClamps™	WP9C	13	CrimpAll™ Tool Kit	WPCATK	28
Copper PEX CrimpRings™	WP14C	13	CrimpRing™ Removal Tool	WPCRT	29
PEX Fittings - Brass		14	Replacement CrimpAll™ and		
CrimpRing™ x Threaded Adapters	LFWP12 (M), LFWP13B-(F)	14	WaterPEX® Unwinder	WPUW	29
CrimpRing™ Sweat Adapters	LFWP10B (M), LFWP11B (F)	14	CrimpMaster™ Tools	WPCMT	29
PEX CrimpRing™ Couplings	LFWP15B	15	WaterPEX® Accessories		30
Transition Coupling Kits	LFWP17B/WP28	15	Washing Machine Shutoff Valves	WPWM	30
Brass PEX x PB (Polybutylene)	LFWP28B	15	Ice Maker Valves	WPIM	30
CrimpRing™ Tees	LFWP18B	16			
CrimpRing™ Elbows - Crimp x Crimp	LFWP19B	17			
Elbows - Crimp x MPT	LFWP20B	17			
CrimpRing™ x Sweat Elbows	LFWP21B	17			
Drop Ear Elbows	LFWP22B	18			
CrimpRing™ Test Plugs	LFWP24B	18			

Terms and Conditions

FREIGHT TERMS: All shipments are F.O.B. shipping point. Shipments from factory less than 1000 lbs. are F.O.B. factory. Factory shipments of \$5000 and over within the continental U.S.A. will be prepaid and allowed when made at the lowest motor carrier transportation rate.

TERMS OF SALE: All sales are F.O.B. shipping point.

PAYMENT TERMS: The invoices are due and payable 30 days from the date of invoice.

PURCHASE ORDER FORMS: Orders submitted on customer's own purchase order forms will be accepted only with the express understanding that no statements, clauses, or conditions contained in said order form will be binding on Watts Regulator Co. ("Watts") if they in any way modify Watts' own terms and conditions of sales.

SPECIAL PRODUCTS: Orders for special or modified products are non-cancelable. In the event that the customer cancels an order for such products, Watts shall charge the customer an amount equal to Watts' costs and expenses incurred in performing the purchase order prior to receipt of notice of cancellation.

LIMITED WARRANTY:

Watts Regulator Co. ("Watts") warrants its potable system components to be free of defects in material and workmanship when used under normal usage and when installed in accordance with all Watts printed installation instructions. Specific warranty durations apply as follows:

1. When installed as a system, Watts warrants its WaterPEX® tubing (all configurations), fittings (brass and plastic), multi-port tees, and manifolds (copper and plastic) to be free of defects in material and workmanship when used under normal conditions in standard potable distribution systems for a period of thirty (30) years from the date of manufacture if known or, if the date of manufacture is not known, from date of shipment. A "system" is defined as piping, fittings and connections, and manifolds. Additional system components may include fasteners or other related accessory items.

Watts pipe, when installed with brass or plastic barbed PEX fittings, multi-port tees, or manifolds manufactured by others and that meet the applicable ASTM Standards (ASTM F 1807) (ASTM F 2159) is warranted to be free of defects in material and workmanship when used under normal conditions for a period of ten (10) years from the date of original shipment.

Watts brass or plastic barbed PEX fittings, multi-port tees, and manifolds, when installed or used individually with cross-linked polyethylene (non-barrier PEX) pipe manufactured by others and that meet the ASTM F 876 requirements, are warranted to be free of defects in material and workmanship when used under normal conditions for a period of two (2) years from the date of original shipment.

Refer to product specific warranties for all other potable components manufactured by Watts.

2. In the event of any such defects during the warranty period, Watts' obligation will be to repair or replace, at its discretion, any material covered under this warranty and proven to be defective. In the event of a system malfunction or leak caused by defective materials (and not by incorrect installation procedures, handling procedures, or jobsite conditions) a reasonable, preapproved amount will be allowed for repair materials and repair labor. In the case of field-assembled configurations, Watts warrants the quality and serviceability of the individual components sold by Watts that the installing contractor incorporates in the manifold assembly, but Watts cannot warrant the complete assembly or any field-assembled connections. That is the responsibility of the installing contractor.

In the event of a malfunction or leak of a system containing other piping and/or fitting manufacturers' components installed within the failed system, Watts will be responsible only for Watts products. Products manufactured by another company should be reported to that manufacturer for their warranty response.

3. In order to qualify for a warranty remedy you must contact Watts in advance and receive a written authorization for this allowance. Repair materials, repair labor, and freight expenses not authorized in writing in advance by Watts will not be compensated.
4. To qualify for the above warranty the following must be completed:
 - a. Use good construction techniques to install Watts materials, as specified in current design and installation guidelines and technical notes. This must include field pressure testing the system and related materials before being covered by concrete or otherwise made inaccessible.
 - b. Install materials according to all specific instructions furnished for the installation.
 - c. Install WaterPEX in a system that will not operate at temperatures exceeding ratings as marked on the tubing.
 - d. Product must be installed in compliance with all applicable plumbing, heating, cooling, and/or mechanical codes.
5. Evidence of tampering, mishandling, neglect, accidental damage, freeze damage, or unauthorized repairs that cause damage to Watts products will void any warranty coverage. All design and supply/return piping to manifold connections are specifically excluded from the terms of this warranty.
6. **THE WARRANTY SET FORTH HEREIN IS GIVEN EXPRESSLY AND IS THE ONLY WARRANTY GIVEN BY WATTS WITH RESPECT TO THE PRODUCTS LISTED IN PARAGRAPH A. WATTS MAKES NO OTHER WARRANTIES, EXPRESS OR IMPLIED. WATTS HEREBY SPECIFICALLY DISCLAIMS ALL OTHER WARRANTIES, EXPRESS OR IMPLIED, INCLUDING BUT NOT LIMITED TO THE IMPLIED WARRANTIES OF MERCHANTABILITY AND FITNESS FOR A PARTICULAR PURPOSE.**
7. The remedy described above shall constitute the sole and exclusive remedy for breach of warranty, and, apart from that remedy, Watts shall not be responsible for any incidental, special or consequential damages, including without limitation, lost profits or the cost of repairing or replacing other property which is damaged if these warranted products do not work properly, other costs resulting from labor charges, delays, vandalism, negligence, fouling caused by foreign material, damage from adverse water conditions, adverse chemical environments, or any other circumstances over which Watts has no control. This warranty shall be invalidated by any abuse, misuse, misapplication or improper installation of the product.

Some states do not allow limitations on how long an implied warranty lasts, and some states do not allow the exclusion or limitation of incidental or consequential damages. Therefore the above limitations may not apply to you. This Limited Warranty gives you specific legal rights, and you may have other rights that vary from state to state. You should consult applicable state laws to determine your rights. **SO FAR AS IS CONSISTENT WITH APPLICABLE STATE LAW, ANY IMPLIED WARRANTIES THAT MAY NOT BE DISCLAIMED, INCLUDING THE IMPLIED WARRANTIES OF MERCHANTABILITY AND FITNESS FOR A PARTICULAR PURPOSE, ARE LIMITED IN DURATION TO ONE YEAR FROM THE DATE OF ORIGINAL SHIPMENT.**

RETURNED GOODS: No material shall be returned without authorization. When credit is issued it will be at the price charged, or prevailing price if lower, less handling charges based on costs of reconditioning, boxing, etc. However, a minimum 25% handling charge will apply. A minimum handling charge of \$200.00 is applied whenever the 25% handling deduction does not total \$200.00. Products which are obsolete or made to special order are not returnable.

NOTE: Prices and terms are subject to change without notice and supersede all previous quotations. The right is reserved to change or modify product design or construction without prior notice and without incurring any obligation to make such changes and modifications on products previously or subsequently sold.

Matrix

MANIFOLDS

CF	Crimp Fitting
CpM	Copper Manifold
MBV	Mini Ball Valve
WPCM-M3	(3 branches)
WPCM-M4	(4 branches)
WPQCM-5	(5 branches)
WPCM-M6	(6 branches)
WPCM-M8	(8 branches)
WPCM-M10	(10 branches)
WPCM-M12	(12 branches)

FITTINGS, STOPS & VALVES

C/Comp.	Compression
CF	Crimp Fitting
CS	Copper Sweat
FIP	Female Iron Pipe
FPT	Female Pipe Thread
FS	Female Sweat
MPT	Male Pipe Thread
MS	Male Sweat
Nom	Nominal
OD	Outside Diameter

CONNECTIONS

1/8 OD = 02
1/4 OD = 04
3/8 OD = 06
1/2 OD = 08
3/4 OD = 12
1 OD = 16
1 1/4 OD = 20
1 1/2 OD = 24
2 OD = 32
1/4 NPT/S = 04
3/8 NPT/S = 06
1/2 NPT/S = 08
3/4 NPT/S = 12
1 NPT/S = 16
1 1/4 NPT/S = 20
1 1/2 NPT/S = 24
2 NPT/S = 32

Codes, Standards, Approvals and Technical Data

Codes, Standards and Approvals

Watts WaterPEX® tubing is manufactured in accordance with ASTM International F876 and F877 to SDR-9 dimensional standards. It is listed by the National Sanitation Foundation to NSF Standards 14 and 61 for use in potable water systems. WaterPEX® tubing is listed by NSF to be in compliance with the Uniform Plumbing Code. All WaterPEX® tubing is labeled B137.5 which indicates that it is compliant to the CSA Standards B137.5.

3.1 WaterPEX is certified by intertek to CAN/ULC S101 and S102, and ASTM E84. WaterPEX is also certified under AWWA C904. All plastic and Lead Free potable components, including WaterPEX pipe, poly alloy and brass fittings are certified to ANSI/NSF 61 Annex G and NSF/ANSI 372.



Chlorine Resistance Category: PEX5306

All Watts WaterPEX® tubing is third party certified by NSF International as meeting the highest chlorine resistance requirements as currently defined by ASTM International F876. The “5” digit indicates that the PEX tubing has been tested and meets the requirements for end use conditions of 100% of the time at 140°F. Watts WaterPEX® tubing therefore can be confidently installed where hot chlorinated potable water is constantly re-circulated.

Engineering/Specification Data and Flow Characteristics

Watts maintains an extensive library of Engineering and Specification sheets for the majority of the WaterPEX products included in this catalog. In addition to ES sheets, pipe and fitting flow data, product specific and installation guidelines for WaterPEX

products may be found on the Watts web site. Information may be accessed at www.watts.com/pex; select the View Details tab for individual products.

Watts WaterPEX® is manufactured in accordance with ASTM International F876 and F877 to SDR-9 dimensional standards. It is listed by the National Sanitation Foundation to NSF Standards 14 and 61 for use in potable water systems. WaterPEX® is listed by NSF to be in compliance to the Uniform Plumbing Code. All WaterPEX® is labeled B137.5 which indicates that it is compliant to the CSA Standards B137.5.



Red, Blue and White Coils

Model No.	Description/Size	Ordering Code	UPC	Net Content	Consumer Unit Weight (lbs)	List Price
-----------	------------------	---------------	-----	-------------	----------------------------	------------

Red Coils

WPTC08-100R	1/2" x 100' coil	0650377	098268310979	100'	6	\$ 136.50
WPTC08-250R	1/2" x 250' coil	0651057	098268358858	250'	14	339.00
WPTC08-300R	1/2" x 300' coil	0650996	098268336160	300'	17	406.00
WPTC08-500R	1/2" x 500' coil	0650378	098268311167	500'	28	673.50
WPTC08-1000R	1/2" x 1000' coil	0650379	098268311174	1000'	55	1,344.00
WPTC12-100R	3/4" x 100' coil	0650380	098268311181	100'	11	237.50
WPTC12-300R	3/4" x 300' coil	0651000	098268337532	300'	32	706.00
WPTC12-500R	3/4" x 500' coil	0650381	098268311198	500'	53	1,168.00
WPTC12-1000R	3/4" x 1000' coil	0650382	098268311204	1000'	105	2,334.00

Blue Coils

WPTC08-100B	1/2" x 100' coil	0650385	098268311242	100'	6	136.50
WPTC08-250B	1/2" x 250' coil	0651055	098268358834	250'	14	339.00
WPTC08-300B	1/2" x 300' coil	0650997	098268336177	300'	17	406.00
WPTC08-500B	1/2" x 500' coil	0650386	098268311259	500'	28	673.50
WPTC08-1000B	1/2" x 1000' coil	0650387	098268311266	1000'	55	1,344.00
WPTC12-100B	3/4" x 100' coil	0650388	098268311273	100'	11	237.50
WPTC12-300B	3/4" x 300' coil	0651001	098268337655	300'	32	706.00
WPTC12-500B	3/4" x 500' coil	0650389	098268311280	500'	53	1,168.00
WPTC12-1000B	3/4" x 1000' coil	0650390	098268311310	1000'	105	2,334.00
WPTC16-100B	1" x 100' coil	0650371	098268527803	100'	17.2	416.00

White Coils

WPTC08-100W	1/2" x 100' coil	0650394	098268311358	100'	6	136.50
WPTC08-250W	1/2" x 250' coil	0651035	098268351989	250'	14	339.00
WPTC08-300W	1/2" x 300' coil	0650998	098268336184	300'	17	406.00
WPTC08-500W	1/2" x 500' coil	0650395	098268311365	500'	28	673.50
WPTC08-1000W	1/2" x 1000' coil	0650396	098268311372	1000'	55	1,344.00
WPTC12-100W	3/4" x 100' coil	0650397	098268311389	100'	11	237.50
WPTC12-250W	3/4" x 250' coil	0651036	098268351729	250'	26	585.50
WPTC16-100W	1" x 100' coil	0650400	098268311419	100'	17	416.00
WPTC16-300W	1" x 300' coil	0651024	098268351934	300'	50.4	1,034.00

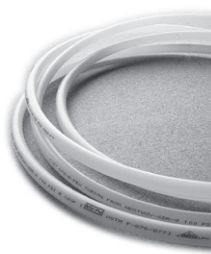
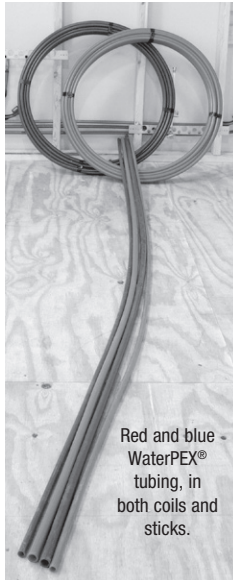

*The wetted surface of this product contacted by consumable water contains less than 0.25% of lead by weight.

Net Content = Quantity of individual pieces or feet contained in the consumer unit.

Red, Blue and White 20' Sticks

Model No.	Description/Size	Ordering Code	UPC	Net Content	Consumer Unit Weight (lbs)	List Price
-----------	------------------	---------------	-----	-------------	----------------------------	------------

Red Sticks

LEAD FREE*	WPTS08-50R	1/2" x 20' Sticks	0650404	098268311464	50 Sticks	43	\$ 1,396.00
	WPTS12-25R	3/4" x 20' Sticks	0650405	098268311471	10 Sticks	21	1,216.00
	WPTS12-10R	3/4" x 20' Sticks	0651029	098268351927	10 Sticks	21	492.00
	WPTS16-5R	1WPx20'-5 Sticks-Red	0651081	098268456066	5 Sticks	18	433.50

Blue Sticks

LEAD FREE*	WPTS08-50B	1/2" x 20' Sticks	0650406	098268311501	50 Sticks	43	1,396.00
	WPTS12-25B	3/4" x 20' Sticks	0650407	098268311518	25 Sticks	21	1,216.00
	WPTS08-25B	1/2" x 20' Sticks	0651025	098268351941	25 Sticks	28	700.00
	WPTS12-10B	3/4" x 20' Sticks	0651028	098268351972	10 Sticks	21	492.00
	WPTS16-5B	1WPx20'-5 Sticks-Blue	0651082	098268456073	5 Sticks	18	433.50

White Sticks

LEAD FREE*	WPTS08-50W	1/2" x 20' Sticks	0650408	098268311525	50 Sticks	43	1,396.00
	WPTS12-25W	3/4" x 20' Sticks	0650409	098268311532	10 Sticks	21	1,216.00
	WPTS16-5W	1" x 20' Sticks	0650410	098268311549	5 Sticks	18	433.50



10' Sticks - Fast Packs

Red Sticks

LEAD FREE*	WPFP08-50R	1/2" x 10' Sticks	0651010	098268340518	50 Sticks	28	723.00
	WPFP12-25R	3/4" x 10' Sticks	0651011	098268340525	25 Sticks	26	629.00

Blue Sticks

LEAD FREE*	WPFP08-50B	1/2" x 10' Sticks	0651012	098268340532	50 Sticks	28	722.00
	WPFP12-25B	3/4" x 10' Sticks	0651013	098268340549	25 Sticks	26	629.00

White Sticks

LEAD FREE*	WPFP12-25W	3/4" x 10' Sticks	0651015	098268340624	25 Sticks	26	629.00
------------	------------	-------------------	---------	--------------	-----------	----	--------

Stud Reel with Tubing

Red

LEAD FREE*	WPSR08-300R	1/2" x 300' Stud Reel	0651020	098268344103	300'	24	454.00
------------	-------------	-----------------------	---------	--------------	------	----	--------

Blue

LEAD FREE*	WPSR08-300B	1/2" x 300' Stud Reel	0651019	098268344080	300'	24	454.00
------------	-------------	-----------------------	---------	--------------	------	----	--------



*The wetted surface of this product contacted by consumable water contains less than 0.25% of lead by weight.

Net Content = Quantity of individual pieces or feet contained in the consumer unit.

Stops and Valves

Model No.	Description/Size	Ordering Code	UPC	Net Content	Net Content Weight (lbs)	List Price
-----------	------------------	---------------	-----	-------------	--------------------------	------------

Full-Port Ball Valves

LEAD FREE*	Model No.	Description/Size	Ordering Code	UPC	Net Content	Net Content Weight (lbs)	List Price
	LFWPABV-08	1/2" F1960 x 1/2" F1960 Full Port Valve	88005387	098268010312	1	0.3	\$ 31.25
	LFWPABV-12	3/4" F1960 x 3/4" F1960 Full Port Valve	88005393	098268010329	1	0.4	39.25
	LFWPABV-16	1" F1960 x 1" F1960 Full Port Valve	88005394	098268010404	1	0.75	54.75

Full-Port Ball Valves with Drain

LEAD FREE*	Model No.	Description/Size	Ordering Code	UPC	Net Content	Net Content Weight (lbs)	List Price
	LFWPABVD-08	1/2" F1960 x 1/2" F1960 Full Port Valve with Drain	88006014	098268002461	1	0.32	32.50
	LFWPABVD-12	3/4" F1960 x 3/4" F1960 Full Port Valve with Drain	88006015	098268010114	1	0.46	41.25
	LFWPABVD-16	1" F1960 x 1" F1960 Full Port Valve with Drain	88006016	098268010305	1	0.84	57.25

*The wetted surface of this product contacted by consumable water contains less than 0.25% of lead by weight.

Net Content = Quantity of individual pieces or feet contained in the consumer unit.

Lead Free* Copper Manifolds (with Lead Free* Brass Fittings and Ball Valves)

Lead Free* Copper manifolds are available in five styles, with or without ball valves. The ends of the manifold trunks are either open, closed, or supplied with 3/4" crimp fittings. Manifolds are made of type "L" copper. All fittings are brass and are brazed to the copper trunk. Order copper CrimpRings™ separately.

Closed End x 1" Swaged End Manifolds

1" diameter manifold trunks are closed at one end and swaged to accept 1" copper at the other. Available with 3/8" and 1/2" brass CrimpRing™ fittings, with or without 1/4-turn brass mini ball valves (MBV), in sizes from M3 to M12. Branches are 2" O.C. Manifolds are sold individually. Order one for hot and one for cold.

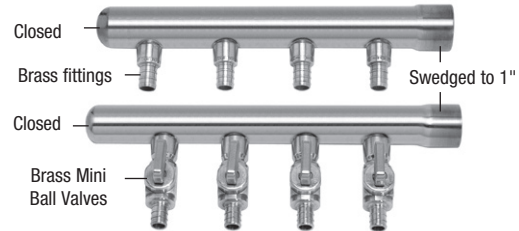

	Model No.	Description/Size	Ordering Code	UPC	Net Content	Consumer Unit Weight (lbs)	List Price
LEAD FREE*	LFWPCM1-M3-08	3 Branch x 1/2" CF	0121097	098268578133	1	1.0	\$ 177.00
	LFWPCM1-M4-08	4 Branch x 1/2" CF	0121098	098268578140	1	1.0	187.00
	LFWPCM1-M6-08	6 Branch x 1/2" CF	0121099	098268578157	1	2.0	195.50
	LFWPCM1-M8-08	8 Branch x 1/2" CF	0121100	098268578164	1	2.0	233.00
	LFWPCM1-M10-08	10 Branch x 1/2" CF	0121101	098268578171	1	2.0	296.00
With Mini Ball Valves (MBV's)							
LEAD FREE*	LFWPCM1-M3-08B	3 Branch x 1/2" CF/MBV	0121103	098268578195	1	2.0	350.50
	LFWPCM1-M4-08B	4 Branch x 1/2" CF/MBV	0121104	098268578201	1	2.0	440.00
	LFWPCM1-M6-08B	6 Branch x 1/2" CF/MBV	0121105	098268578218	1	3.0	559.50
	LFWPCM1-M8-08B	8 Branch x 1/2" CF/MBV	0121106	098268578225	1	3.0	697.50
	LFWPCM1-M10-08B	10 Branch x 1/2" CF/MBV	0121107	098268578249	1	5.0	817.50
	LFWPCM1-M12-08B	12 Branch x 1/2" CF/MBV	0121108	098268578256	1	5.0	973.00

*The wetted surface of this product contacted by consumable water contains less than 0.25% of lead by weight.

Net Content = Quantity of individual pieces or feet contained in the consumer unit.

Lead Free* Copper Manifolds (with Lead Free* Brass Fittings and Ball Valves)

Lead Free* Copper manifolds are available in five styles, with or without ball valves. The ends of the manifold trunks are either open, closed, or supplied with 3/4" crimp fittings. Manifolds are made of type "L" copper. All fittings are brass and are brazed to the copper trunk. Order copper CrimpRings™ separately.

Closed End x 3/4" CrimpRing™ End Manifolds

1" diameter manifold trunks are closed at one end and have a 3/4" brass CrimpRing™ fitting at the supply end. Available with 1/2" brass CrimpRing™ fittings, with or without 1/4-turn brass mini ball valves (MBV), in sizes from M3 to M12. Branches are 2" O.C. Manifolds are sold individually. Order one for hot and one for cold.

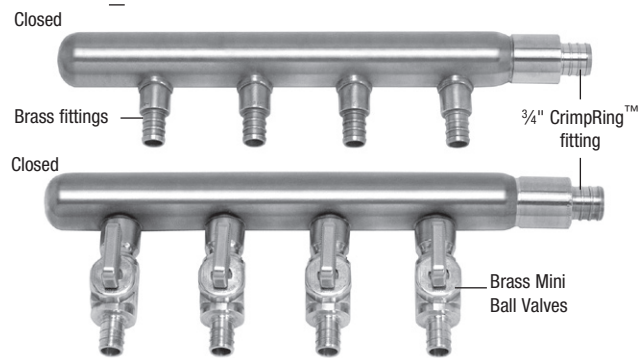

	Model No.	Description/Size	Ordering Code	UPC	Net Content	Consumer Unit Weight (lbs)	List Price
LEAD FREE*	LFWPCM2-M4-08	4 Branch x 3/4" CF - 1/2" CF	0121110	098268578270	1	1.0	\$ 187.00
	LFWPCM2-M6-08	6 Branch x 3/4" CF - 1/2" CF	0121111	098268578287	1	2.0	218.00
	LFWPCM2-M8-08	8 Branch x 3/4" CF - 1/2" CF	0121112	098268578294	1	2.0	264.00
	LFWPCM2-M10-08	10 Branch x 3/4" CF - 1/2" CF	0121113	098268578331	1	3.0	326.00
With Mini Ball Valves (MBV's)							
LEAD FREE*	LFWPCM2-M4-08B	4 Branch x 3/4" CF - 1/2" CF/MBV	0121116	098268578409	1	2.0	452.50
	LFWPCM2-M6-08B	6 Branch x 3/4" CF - 1/2" CF/MBV	0121117	098268578515	1	3.0	592.00
	LFWPCM2-M8-08B	8 Branch x 3/4" CF - 1/2" CF/MBV	0121118	098268578522	1	4.0	729.50
	LFWPCM2-M10-08B	10 Branch x 3/4" CF - 1/2" CF/MBV	0121119	098268578546	1	5.0	848.00

Lead Free* Copper Manifolds (with Lead Free* Brass Fittings and Ball Valves)

3/4" CrimpRing™ End x 3/4" CrimpRing™ End "Flow-Through" Manifolds

Flow-through manifolds have 3/4" brass CrimpRing™ fittings at both ends. This allows water supply to continue through the manifold to the next group of fixtures. Available with 1/2" brass CrimpRing™ fittings, with or without 1/4-turn brass mini ball valves (MBV), in sizes from M3 to M12. Branches are 2" O.C. Manifolds are sold individually. Order one for hot and one for cold.

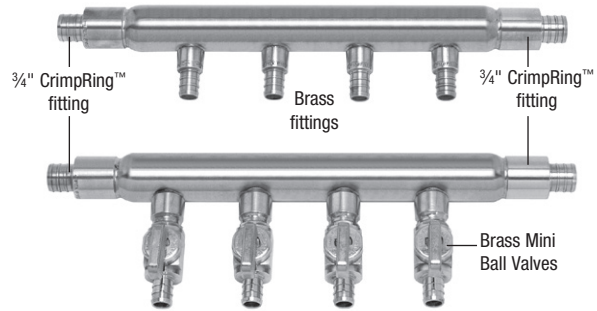

	Model No.	Description/Size	Ordering Code	UPC	Net Content	Consumer Unit Weight (lbs)	List Price
LEAD FREE*	LFWPCM3-3-08	3 Branch x 3/4" CF x 3/4" CF - 1/2" CF	0121121	098268578577	1	1.0	\$ 206.00
	LFWPCM3-M4-08	4 Branch x 3/4" CF x 3/4" CF - 1/2" CF	0121122	098268578584	1	1.0	218.00
	LFWPCM3-M6-08	6 Branch x 3/4" CF x 3/4" CF - 1/2" CF	0121123	098268578591	1	2.0	251.50
	LFWPCM3-M8-08	8 Branch x 3/4" CF x 3/4" CF - 1/2" CF	0121124	098268578621	1	2.0	296.00
	LFWPCM3-M10-08	10 Branch x 3/4" CF x 3/4" CF - 1/2" CF	0121125	098268578638	1	2.0	357.00
	LFWPCM3-M12-08	12 Branch x 3/4" CF x 3/4" CF - 1/2" CF	0121126	098268578645	1	3.0	397.50
With Mini Ball Valves (MBV's)							
LEAD FREE*	LFWPCM3-M4-08B	4 Branch x 3/4" CF x CF - 1/2" CF/MBV	0121128	098268578669	1	2.0	482.00
	LFWPCM3-M6-08B	6 Branch x 3/4" CF x CF - 1/2" CF/MBV	0121129	098268578676	1	3.0	623.00
	LFWPCM3-M8-08B	8 Branch x 3/4" CF x CF - 1/2" CF/MBV	0121140	098268579031	1	4.0	760.50
	LFWPCM3-M10-08B	10 Branch x 3/4" CF x CF - 1/2" CF/MBV	0121130	098268578683	1	5.0	879.50
	LFWPCM3-M12-08B	12 Branch x 3/4" CF x CF - 1/2" CF/MBV	0121131	098268578690	1	5.0	1,034.00

*The wetted surface of this product contacted by consumable water contains less than 0.25% of lead by weight.

Net Content = Quantity of individual pieces or feet contained in the consumer unit.

Lead Free* Copper Manifolds (with Lead Free* Brass Fittings and Ball Valves)

CustomCut™ Copper Manifolds - 1 Trunk x 16 - Branch - 3" O.C. Fittings

CustomCuts™ are designed to be cut up in the field. Cut off five branches for a 5-branch manifold, seven for a 7-branch manifold, etc. All CustomCuts™ are 4' long with 16 fittings spaced 3" apart, so a pipe cutter can fit between the branches. CustomCuts™ come with or without MBVs, with either 3/8" crimp fittings, 1/2" crimp fittings, or with 1/2" base branches to accept any type of 1/2" nominal crimp fitting or Watts Mini Ball Valve (MBV). All fittings are Lead Free brass.

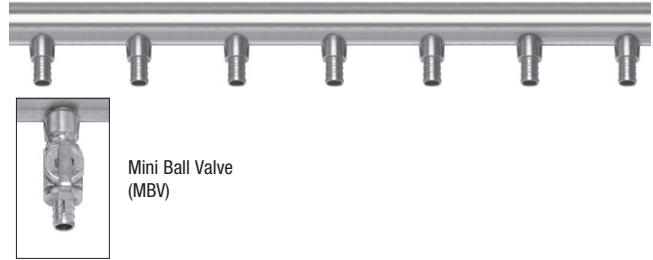

Model No.	Description/Size	Ordering Code	UPC	Net Content	Consumer Unit Weight (lbs)	List Price
LEAD FREE* LFWPCM5-M16-08	16 Branch x 1/2" CF	0121136	098268578744	1	5.0	519.00

Putting it Together.

Manifolds are the heart of the WaterPEX® plumbing system. Choosing the correct manifold is important. The photograph at left shows an example of a "flow-through" manifold configuration and some of the WaterPEX® components that make it work.

All Watts copper manifolds are made with brass fittings and brass ball valves.

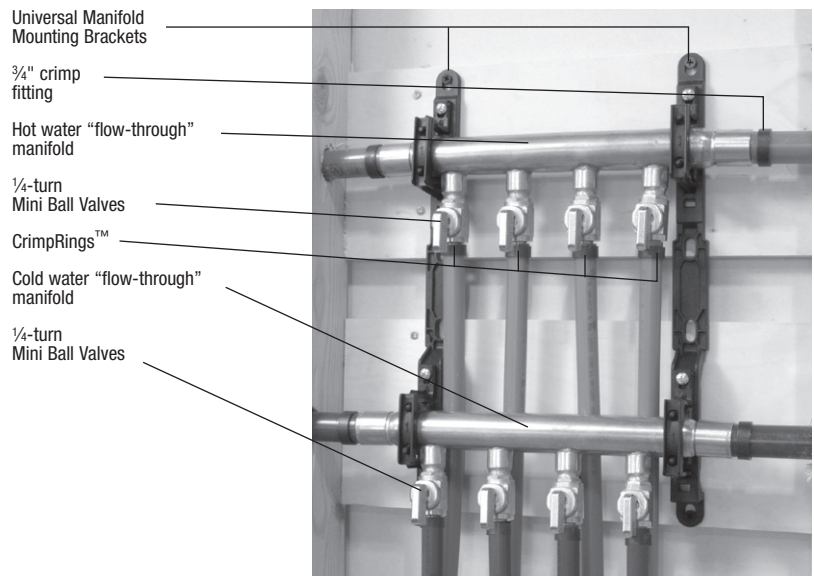

*The wetted surface of this product contacted by consumable water contains less than 0.25% of lead by weight.

Net Content = Quantity of individual pieces or feet contained in the consumer unit.

PEX Valves and Accessories

Stops and Valves

1/4-Turn Chrome Stops

Ever snapped the stem off a plastic stop? These solid brass valves (even the stem is brass) open or shut in a 1/4-turn. Trusted Watts quality in a chrome plated ball valve. Best choice for longevity and frequent use. Sweat, compression, or crimp fittings provide for a quick, reliable connection.



LEAD FREE*

Model No.	Description/Size	Ordering Code	UPC	Net Content	Consumer Unit Weight (lbs)	Case Qty	Case Weight (lbs)	List Price
LFWPSS-1PB	1/2" PEX Barb x 3/8" OD Comp. Straight	0121141	098268730593	1	1.0	50	50	\$ 24.50

PEX Stops

These 1/4-turn Stops include insert stiffeners and compression rings for use with 1/2" WaterPEX®. Brass or chrome sleeves (sold separately) slide over 1/2" WaterPEX® to give a sleek, finished appearance all the way to the wall.

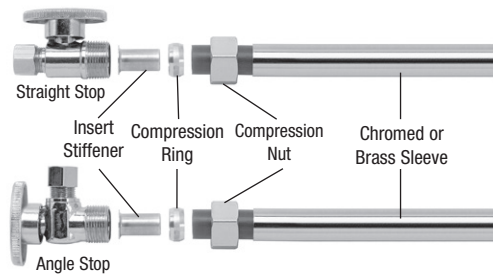

Model No.	Description/Size	Ordering Code	UPC	Net Content	Consumer Unit Weight (lbs)	Case Qty	Case Weight (lbs)	List Price
PolyBag								
WPChS-1PB	Chrome sleeve 5" - 1/2"	0650477	098268312553	1	0.01	10	0.1	19.00
WPIS-1PB	PEX Insert Stiffener - 1/2"	0650478	098268312560	1	2.0	1	2	8.25

Putting it Together.

The perfect bathroom setup. The photograph at right shows an example of a real-world PEX configuration for a bathroom sink and some of the WaterPEX® components that make it work.

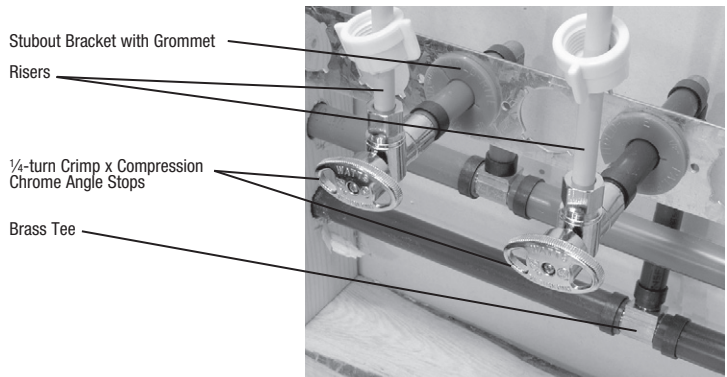

*The wetted surface of this product contacted by consumable water contains less than 0.25% of lead by weight.

Net Content = Quantity of individual pieces or feet contained in the consumer unit.

PEX Valves and Accessories

Valves

In-line Crimp x Crimp Full Port Ball Valves

No soldering, no threading, and no waiting. Just slip a length of WaterPEX® pipe over the barbs, and crimp into place. Solid, leak-proof connection completed in a matter of seconds.

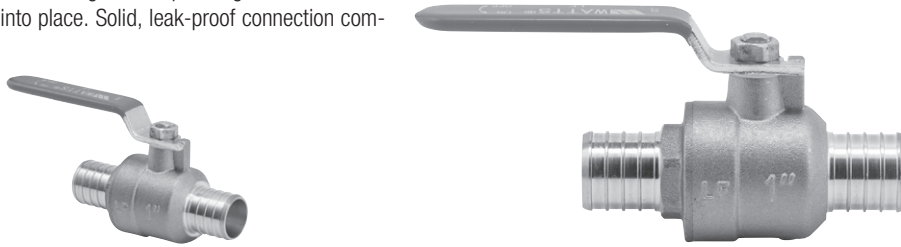

	Model No.	Description/Size	Ordering Code	UPC	Net Content	Consumer Unit Weight (lbs)	Case Qty	Case Weight (lbs)	List Price
LEAD FREE*	LFWPBV-08	1/2" CF x 1/2" CF	0653000	098268441123	1	1.0	40	40	\$ 29.00
	LFWPBV-12	3/4" CF x 3/4" CF	0653001	098268441130	1	1.0	40	40	46.75
	LFWPBV-16	1" CF x 1" CF	0653002	098268441147	1	1.0	24	24	81.50

In-line Crimp x Crimp Full Port Ball Valves with Waste Drain

This valve is the same as the Crimp x Crimp full port ball valve, but it includes a waste drain for draining with the valve in the closed position.

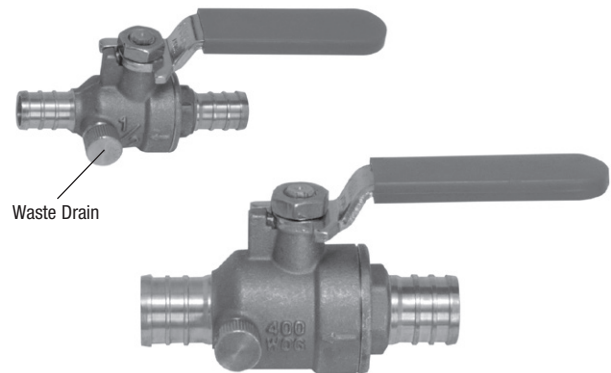

	Model No.	Description/Size	Ordering Code	UPC	Net Content	Consumer Unit Weight (lbs)	Case Qty	Case Weight (lbs)	List Price
LEAD FREE*	LFWPBVD-08	1/2" CF x 1/2" CF with Waste Drain	0653003	098268441154	1	1.0	40	40	\$ 53.25
	LFWPBVD-12	3/4" CF x 3/4" CF with Waste Drain	0653004	098268441161	1	1.0	40	40	80.50

*The wetted surface of this product contacted by consumable water contains less than 0.25% of lead by weight.

Net Content = Quantity of individual pieces or feet contained in the consumer unit.

CrimpRing™ and CinchClamps™

Stainless Steel CinchClamps™

Perfect for connecting PEX to crimp-type fittings in hard-to-reach spaces. Simply pinch the tab closed with the CinchTool™ to make the connection. CinchClamps™ are made from corrosion-resistant annealed 304 stainless steel (meets NSF/ANSI Std. 14, ASTM International 2098).

NOTICE Watts WaterPEX CinchClamp™ fittings should not be used with wrought copper PEX fittings. When using CinchClamps when the ambient air temperature is below 30°F, extra care must be taken while making the connection. Keep the CinchClamps in a warm place if possible, and make the cinch at a slow, even pace. Failure to do so may cause the CinchClamp not to seal properly.



Model No.	Description/Size	Ordering Code	UPC	Net Content	Consumer Unit Weight (lbs)	Case Qty	Case Weight (lbs)	List Price
PolyBag								
WP9S-12PB	3/4"	0650539	098268313246	10	0.2	10	2	\$ 25.25
WP9S-16PB	1"	0650540	098268313253	10	0.2	10	2	28.25
Bulk (Bagged)								
WP9S-06	3/8"	0650541	098268313260	100	0.8	10	8	155.50
WP9S-08	1/2"	0650542	098268313277	100	1.0	10	10	155.50
WP9S-16	1"	0650544	098268313291	100	3.3	4	13	241.00

Close Ear (CE) CinchClamp™



Model No.	Description/Size	Ordering Code	UPC	Net Content	Consumer Unit Weight (lbs)	Case Qty	Case Weight (lbs)	List Price
Bulk (Bagged)								
WP9CE-08	1/2"	0651817	098268774856	100	1.08	10	10.8	\$ 171.50

Copper PEX CrimpRings™

Proven by 20 years of experience, annealed copper CrimpRings™ provide a quick, safe, and reliable connection to WaterPEX® SDR-9 pipe. Simply slide one of these CrimpRings™ over the WaterPEX® pipe and crimp into place with the crimp tool.



Model No.	Description/Size	Ordering Code	UPC	Net Content	Consumer Unit Weight (lbs)	Case Qty	Case Weight (lbs)	List Price
PolyBag								
WP14C-06PB	3/8"	0650545	098268313307	10	0.1	10	1	\$ 14.25
WP14C-08PB	1/2"	0650546	098268313314	10	0.2	10	1	13.00
WP14C-12PB	3/4"	0650547	098268313321	10	0.1	10	1	14.50
WP14C-16PB	1"	0650548	098268313338	10	0.1	10	1	22.75
Bulk (Bagged)								
WP14C-06	3/8"	0650550	098268313352	100	1.2	–	–	107.00
WP14C-08	1/2"	0650551	098268313369	100	1.55	–	–	93.50
WP14C-12	3/4"	0650552	098268313376	100	2.0	–	–	111.50
WP14C-16	1"	0650553	098268313383	100	2.5	–	–	185.00
WP14C-20	1 1/4"	0650554	098268313390	100	3.3	–	–	547.50

PEX Fittings - Brass

CrimpRing™ x Threaded Adapter

Thread adapters into the appropriate NPT fitting.



Model No.	Description/Size	Ordering Code	UPC	Net Content	Consumer Unit Weight (lbs)	Case Qty	Case Weight (lbs)	List Price
PolyBag								
LFWP12B-0608PB	3/8" CF x 1/2" MPT	0653023	098268441352	10	0.9	10	9	\$ 102.00
LFWP12B-0808PB	1/2" CF x 1/2" MPT	0653024	098268441369	10	1.1	10	11	102.00
LFWP12B-0812PB	1/2" CF x 3/4" MPT	0653025	098268441376	10	1.2	100	12	143.00
LFWP12B-1208PB	3/4" CF x 1/2" MPT	0653026	098268441383	10	1.1	10	11	126.00
LFWP12B-1212PB	3/4" CF x 3/4" MPT	0653027	098268441390	10	1.4	10	14	152.50
LFWP12B-1216PB	3/4" CF x 1" MPT	0653028	098268441406	3	1.4	10	14	42.00
LFWP12B-1612PB	1" CF x 3/4" MPT	0653029	098268441413	3	0.5	10	19	61.00
LFWP12B-1616PB	1" CF x 1" MPT	0653030	098268441420	3	2.4	10	24	65.50
LFWP13B-0808PB	1/2" CF x 1/2" FPT	0653032	098268441444	5	1.4	10	14	65.25
LFWP13B-0812PB	1/2" CF X 3/4" FTP	0653155	098268442670	10	1.9	100	19	206.00
LFWP13B-1212PB	3/4" CF x 3/4" FPT	0653033	098268441451	5	1.0	20	19	70.00
LFWP13B-1616PB	1" CF x 1" FPT	0653162	098268442748	10	2.8	4	11	185.00
Bulk								
LFWP13B-0808	1/2" CF x 1/2" FPT	0653043	098268441550	100	14.0	-	-	1,183.00
LFWP13B-1212	3/4" CF x 3/4" FPT	0653044	098268441567	100	19.0	-	-	1,280.00

CrimpRing™ Sweat Adapters

Sweat adapters onto a copper pipe to transition to WaterPEX® supply lines.

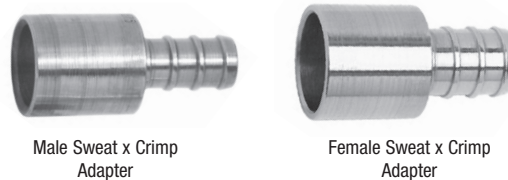

Model No.	Description/Size	Ordering Code	UPC	Net Content	Consumer Unit Weight (lbs)	Case Qty	Case Weight (lbs)	List Price
PolyBag								
LFWP10B-0806PB	1/2" MS x 3/8" CF	0653005	098268441178	10	.3	10	3	\$ 66.75
LFWP10B-0808PB	1/2" MS x 1/2" CF	0653006	098268441185	10	.5	10	5	54.50
LFWP10B-1212PB	3/4" MS x 3/4" CF	0653007	098268441192	5	.8	10	8	48.50
LFWP10B-1616PB	1" MS x 1" CF	0653008	098268441208	5	.8	10	8	130.00
LFWP11B-0808PB	1/2" FS x 1/2" CF"	0653010	098268441222	10	.4	10	4	55.50
LFWP11B-0812PB	1/2" FS x 3/4" CF	0653168	098268442809	10	1.4	10	14	79.75
LFWP11B-1212PB	3/4" FS x 3/4" CF	0653011	098268441239	10	1.2	10	12	90.25
LFWP11B-1616PB	1" FS x 1" CF	0653012	098268441246	5	1.4	10	14	95.75
Bulk								
LFWP10B-0808	1/2" MS x 1/2" CF	0653015	098268441277	100	5.0	-	-	487.50
LFWP10B-1212	3/4" MS x 3/4" CF	0653016	098268441284	100	8.0	-	-	879.00
LFWP11B-0808	1/2" FS x 1/2" CF	0653019	098268441314	100	4.0	-	-	499.50
LFWP11B-1212	3/4" FS x 3/4" CF	0653020	098268441321	100	12	-	-	830.00
LFWP11B-1616	1" FS x 1" CF	0653021	098268441338	100	14	-	-	1,901.00

PEX Fittings - Brass

PEX CrimpRing™ Couplings

For making field repairs or continuing a run. Order CrimpRings™ separately.



PEX x PEX

Model No.	Description/Size	Ordering Code	UPC	Net Content	Consumer Unit Weight (lbs)	Case Qty	Case Weight (lbs)	List Price
-----------	------------------	---------------	-----	-------------	----------------------------	----------	-------------------	------------

PolyBag

LEAD FREE*	LFWP15B-0606PB	3/8" CF x 3/8" CF	0653045	098268441574	10	0.2	10	2	\$ 50.50
	LFWP15B-0806PB	1/2" CF x 3/8" CF	0653046	098268441581	10	0.3	10	3	55.50
	LFWP15B-0808PB	1/2" CF x 1/2" CF	0653047	098268441598	10	0.3	10	3	43.50
	LFWP15B-1208PB	3/4" CF x 1/2" CF	0653048	098268441604	10	0.5	10	5	72.50
	LFWP15B-1212PB	3/4" CF x 3/4" CF	0653049	098268441611	10	.5	10	5	52.75
	LFWP15B-1612PB	1" CF x 3/4" CF	0653050	098268441628	10	1.0	10	10	98.25
	LFWP15B-1616PB	1" CF x 1" CF	0653051	098268441635	20	1.8	5	9	189.00

Bulk

LEAD FREE*	LFWP15B-0808	1/2" CF x 1/2" CF	0653056	098268441680	100	3.0	-	-	387.00
	LFWP15B-1212	3/4" CF x 3/4" CF	0653058	098268441703	100	5.0	-	-	471.00

Brass PEX x PB (Polybutylene) Transition Couplings Kits

For transitioning from polybutylene pipe to WaterPEX®. Each kit contains 2 copper CrimpRings™ and one PEX to PB coupling.



PEX x PB

Model No.	Description/Size	Ordering Code	UPC	Net Content	Consumer Unit Weight (lbs)	Case Qty	Case Weight (lbs)	List Price
-----------	------------------	---------------	-----	-------------	----------------------------	----------	-------------------	------------

LEAD FREE*	LFWP17B-08PB	1/2" Coupling kit	0653148	098268442601	10	0.56	100	5.6	190.00
	LFWP17B-12PB	3/4" Coupling kit	0653149	098268442618	10	1.3	100	13	245.00
	LFWP28B-08PB	1/2" CF X 1/2" PB Coupling only	0653170	098268442823	10	2	100	20	124.50
	LFWP28B-12PB	3/4" CF x 3/4" PB Coupling only	0653171	098268442830	10	3	100	30	169.50

*The wetted surface of this product contacted by consumable water contains less than 0.25% of lead by weight.

Net Content = Quantity of individual pieces or feet contained in the consumer unit.

PEX Fittings - Brass

CrimpRing™ Tees x Run X Branch

making directional changes in potable systems.

(Run
Used for

Run
1



Run
2

Branch
3

Model No.	Description/Size	Ordering Code	UPC	Net Content	Consumer Unit Weight (lbs)	Case Qty	Case Weight (lbs)	List Price
-----------	------------------	---------------	-----	-------------	----------------------------	----------	-------------------	------------

PolyBag

Model No.	Description/Size	Ordering Code	UPC	Net Content	Consumer Unit Weight (lbs)	Case Qty	Case Weight (lbs)	List Price
LFWP18B-08PB	1/2" CF x 1/2" CF x 1/2" CF	0653072	098268441840	10	0.8	10	8	82.25
LFWP18B-080812PB	1/2" CF x 1/2" CF x 3/4" CF	0653073	098268441857	10	0.8	10	8	114.00
LFWP18B-120808PB	3/4" CF x 1/2" CF x 1/2" CF	0653074	098268441864	10	0.9	10	9	117.00
LFWP18B-120812PB	3/4" CF x 1/2" CF x 3/4" CF	0653075	098268441871	10	1.1	10	11	123.00
LFWP18B-121206PB	3/4" CF x 3/4" CF x 3/8" CF	0653076	098268441888	10	0.8	10	8	159.50
LFWP18B-121208PB	3/4" CF x 3/4" CF x 1/2" CF	0653077	098268441895	10	1.1	10	11	124.50
LFWP18B-12PB	3/4" CF x 3/4" CF x 3/4" CF	0653078	098268441901	10	1.3	10	13	112.50
LFWP18B-121216PB	3/4" CF x 3/4" CF x 1" CF	0653079	098268441918	10	2.4	5	12	270.50
LFWP18B-161212PB	1" CF x 3/4" CF x 3/4" CF	0653080	098268441925	10	2.6	5	13	270.50
LFWP18B-161608PB	1" CF x 1" CF x 1/2" CF	0653081	098268441932	10	2.8	5	14	264.00
LFWP18B-161612PB	1" CF x 1" CF x 3/4" CF	0653082	098268441949	10	3.0	5	15	255.50
LFWP18B-16PB	1" CF x 1" CF x 1" CF	0653083	098268441956	10	3.2	5	16	259.50

Bulk

Model No.	Description/Size	Ordering Code	UPC	Net Content	Consumer Unit Weight (lbs)	Case Qty	Case Weight (lbs)	List Price
LFWP18B-08	1/2" CF x 1/2" CF x 1/2" CF	0653088	098268442007	100	8.0	-	-	762.50
LFWP18B-120808	3/4" CF x 1/2" CF x 1/2" CF	0653090	098268442021	100	9.0	-	-	1,085.00
LFWP18B-120812	3/4" CF x 1/2" CF x 3/4" CF	0653091	098268442038	100	11.0	-	-	1,135.00
LFWP18B-121208	3/4" CF x 3/4" CF x 1/2" CF	0653093	098268442052	100	11.0	-	-	1,152.00
LFWP18B-12	3/4" CF x 3/4" CF x 3/4" CF	0653094	098268442069	100	13.0	-	-	1,040.00

*The wetted surface of this product contacted by consumable water contains less than 0.25% of lead by weight.

Net Content = Quantity of individual pieces or feet contained in the consumer unit.

PEX Fittings - Brass

CrimpRing™ Elbows - Crimp x Crimp

Used to make a 90° change between WaterPEX®.



Model No.	Description/Size	Ordering Code	UPC	Net Content	Consumer Unit Weight (lbs)	Case Qty	Case Weight (lbs)	List Price
-----------	------------------	---------------	-----	-------------	----------------------------	----------	-------------------	------------

PolyBag

LEAD FREE*	LFWP19B-06PB	3/8" CF x 3/8" CF	0653100	098268442120	10	0.35	10	3.5	\$ 75.25
	LFWP19B-08PB	1/2" CF x 1/2" CF	0653101	098268442137	10	0.47	10	4.7	64.75
	LFWP19B-1208PB	3/4" CF x 1/2" CF	0653102	098268442144	10	.22	10	2.2	117.00
	LFWP19B-1212PB	3/4" CF x 3/4" CF	0653103	098268442151	10	.22	10	2.2	84.50
	LFWP19B-16PB	1" CF x 1" CF	0653104	098268442168	10	.21	10	2.1	212.50

Bulk

LEAD FREE*	LFWP19B-08	1/2" CF x 1/2" CF	0653106	098268442182	100	4.0	-	-	588.00
	LFWP19B-1212	3/4" CF x 3/4" CF	0653108	098268442205	100	8.0	-	-	784.00
	LFWP19B-16	1" CF x 1" CF	0653109	098268442212	100	18.0	-	-	1,987.00

Elbows - Crimp x MPT

Used to make a 90° change between WaterPEX® and threaded pipe.



Model No.	Description/Size	Ordering Code	UPC	Net Content	Consumer Unit Weight (lbs)	Case Qty	Case Weight (lbs)	List Price
-----------	------------------	---------------	-----	-------------	----------------------------	----------	-------------------	------------

PolyBag

LEAD FREE*	LFWP20B-0806PB	1/2" CF x 3/8" MPT	0653110	098268442229	10	1.4	10	14	\$ 213.00
	LFWP20B-0808PB	1/2" CF x 1/2" MPT	0653111	098268442236	10	2.6	10	26	252.50
	LFWP20B-12PB	3/4" CF x 3/4" MPT	0653113	098268442250	10	2.03	100	22.03	346.50

CrimpRing™ x Sweat Elbows

Use these elbows when making tight turns.



Model No.	Description/Size	Ordering Code	UPC	Net Content	Consumer Unit Weight (lbs)	Case Qty	Case Weight (lbs)	List Price
-----------	------------------	---------------	-----	-------------	----------------------------	----------	-------------------	------------

PolyBag

LEAD FREE*	LFWP21B-08PB	1/2" CF x 1/2" FS	0653163	098268442755	10	1.0	10	10	\$ 259.50
	LFWP21B-0812PB	1/2" CF x 3/4" FS	0653118	098268442304	10	1.2	10	12	333.50
	LFWP21B-12PB	3/4" CF x 3/4" FS	0653119	098268442311	10	1.6	10	16	356.50

*The wetted surface of this product contacted by consumable water contains less than 0.25% of lead by weight.

Net Content = Quantity of individual pieces or feet contained in the consumer unit.

PEX Fittings - Brass

Drop Ear Elbows

For making 90° change between WaterPEX® and threaded pipe.

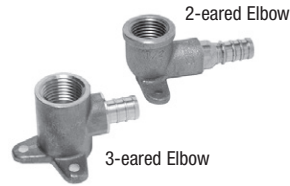

Model No.	Description/Size	Ordering Code	UPC	Net Content	Consumer Unit Weight (lbs)	Case Qty	Case Weight (lbs)	List Price	
PolyBag									
LEAD FREE*	LFWP22B-0608PB	3/8" CF x 1/2" FPT - 2 eared	0653122	098268442342	10	1.8	10	18	\$ 331.50
LEAD FREE*	LFWP22B-08PB	1/2" CF x 1/2" FPT - 2 eared	0653123	098268442359	10	1.7	10	17	275.00
LEAD FREE*	LFWP23B-08PB	1/2" CF x 1/2" FPT - 3 eared	0653124	098268442366	10	1.7	10	17	306.50
LEAD FREE*	LFWP22B-1208PB	3/4" CF x 1/2" FPT - 2 eared	0653125	098268442373	10	1.8	5	18	454.00
LEAD FREE*	LFWP22B-12PB	3/4" CF x 3/4" FPT - 2 eared	0653126	098268442380	10	1.8	5	18	406.00
Bulk									
LEAD FREE*	LFWP22B-08	1/2" CF x 1/2" FPT - 2 eared	0653128	098268442403	100	17.0	-	-	2,563.00
LEAD FREE*	LFWP23B-08	1/2" CF x 1/2" FPT - 3 eared	0653129	098268442410	100	17.0	-	-	2,988.00

CrimpRing™ Test Plugs

Used for pressure testing the system.



Model No.	Description/Size	Ordering Code	UPC	Net Content	Consumer Unit Weight (lbs)	Case Qty	Case Weight (lbs)	List Price	
PolyBag									
LEAD FREE*	LFWP24B-06PB	3/8" CF	0653132	098268442441	10	0.2	10	2	\$ 43.50
LEAD FREE*	LFWP24B-08PB	1/2" CF	0653133	098268442458	10	.3	10	3	40.50
LEAD FREE*	LFWP24B-12PB	3/4" CF	0653134	098268442465	10	.6	10	6	53.75
LEAD FREE*	LFWP24B-16PB	1" CF	0653135	098268442472	10	1.0	10	10	65.75

*The wetted surface of this product contacted by consumable water contains less than 0.25% of lead by weight.

Net Content = Quantity of individual pieces or feet contained in the consumer unit.

PEX Fittings – Poly-Alloy

Poly-Alloy CrimpRing™ fittings are a perfect match for Watts WaterPEX®. These fittings are produced from an engineered thermoplastic polymer called PPSU. PPSU resin offers many improved performance characteristics that make it an excellent choice for molded components installed in the demanding environment of a hot and cold-water plumbing system.

Poly-Alloy CrimpRing™ fittings are made to ASTM International F2159 and F877 standards. They have the NSF-pw rating and are certified to Canadian Standard Association B137.5.

CrimpRing™ Couplings

For making field repairs or continuing a run. Order CrimpRings™ separately.



Model No.	Description/Size	Ordering Code	UPC	Net Content	Consumer Unit Weight (lbs)	Case Qty	Case Weight (lbs)	List Price
PolyBag								
WP15P-08PB	1/2" CF x 1/2" CF	0650655	098268314915	10	0.1	10	1	\$ 22.75
WP15P-1208PB	3/4" CF x 1/2" CF	0650656	098268314922	10	0.5	10	5	31.25
WP15P-12PB	3/4" CF x 3/4" CF	0650657	098268314939	10	0.1	10	1	28.75
WP15P-1612PB	1" CF x 3/4" CF	0650658	098268314946	10	0.2	10	2	46.00
WP15P-16PB	1" CF x 1" CF	0650659	098268314953	10	0.2	10	2	48.50

Bulk

LEAD FREE*	WP15P-08	1/2" CF x 1/2" CF	0650660	098268314960	100	1.0	–	–	187.00
LEAD FREE*	WP15P-12	3/4" CF x 3/4" CF	0650662	098268314984	100	1.0	–	–	251.50

CrimpRing™ Elbows

Used to make a 90° change between WaterPEX®.



Model No.	Description/Size	Ordering Code	UPC	Net Content	Consumer Unit Weight (lbs)	Case Qty	Case Weight (lbs)	List Price
PolyBag								
WP19P-08PB	1/2" CF x 1/2" CF	0650665	098268315103	10	0.1	10	1	\$ 28.75
WP19P-1208PB	3/4" CF x 1/2" CF	0650666	098268315110	10	0.2	10	2	39.25
WP19P-1212PB	3/4" CF x 3/4" CF	0650667	098268315127	10	0.2	10	2	41.00
WP19P-16PB	1" CF x 1" CF	0650668	098268315141	10	0.5	10	5	109.00

Bulk

LEAD FREE*	WP19P-08	1/2" CF x 1/2" CF	0650669	098268315158	100	1.0	–	–	245.00
LEAD FREE*	WP19P-1212	3/4" CF x 3/4" CF	0650671	098268315172	100	2.0	–	–	360.00

*The wetted surface of this product contacted by consumable water contains less than 0.25% of lead by weight.

Net Content = Quantity of individual pieces or feet contained in the consumer unit.

PEX Fittings – Poly-Alloy

CrimpRing™ x MPT Adapter

Thread adapters into the appropriate NPT fitting.



Model No.	Description/Size	Ordering Code	UPC	Net Content	Consumer Unit Weight (lbs)	Case Qty	Case Weight (lbs)	List Price
-----------	------------------	---------------	-----	-------------	----------------------------	----------	-------------------	------------

PolyBag

LEAD FREE*	WP12P-08PB	1/2" CF x 1/2" MPT	0650673	098268315196	10	0.2	10	2	\$ 32.75
	WP12P-12PB	3/4" CF x 3/4" MPT	0650675	098268315219	10	0.2	10	2	41.00

CrimpRing™ x MPT Elbow

Used to make a 90° change between WaterPEX® and threaded pipe.



Model No.	Description/Size	Ordering Code	UPC	Net Content	Consumer Unit Weight (lbs)	Case Qty	Case Weight (lbs)	List Price
-----------	------------------	---------------	-----	-------------	----------------------------	----------	-------------------	------------

PolyBag

LEAD FREE*	WP20P-08PB	1/2" CF x 1/2" MPT	0650679	098268315257	10	0.2	10	2	\$ 38.00
	WP20P-1208PB	3/4" CF x 1/2" MPT	0650680	098268315264	10	0.3	10	3	49.25
	WP20P-1212PB	3/4" CF x 3/4" MPT	0650681	098268315271	10	0.3	10	3	54.75

*The wetted surface of this product contacted by consumable water contains less than 0.25% of lead by weight.

Net Content = Quantity of individual pieces or feet contained in the consumer unit.

PEX Fittings – Poly-Alloy

CrimpRing™ Tees (Run x Run x Branch)

Used for making directional changes in potable systems.



Model No.	Description/Size	Ordering Code	UPC	Net Content	Consumer Unit Weight (lbs)	Case Qty	Case Weight (lbs)	List Price
-----------	------------------	---------------	-----	-------------	----------------------------	----------	-------------------	------------

PolyBag

1 2 3

LEAD FREE*	WP18P-08PB	1/2" CF x 1/2" CF x 1/2" CF	0650685	098268315356	10	0.2	10	2	\$ 31.75
	WP18P-080812PB	1/2" CF x 1/2" CF x 3/4" CF	0650686	098268315363	10	0.2	10	2	44.00
	WP18P-12PB	3/4" CF x 3/4" CF x 3/4" CF	0650687	098268315370	10	0.3	10	3	44.00
	WP18P-121208PB	3/4" CF x 3/4" CF x 1/2" CF	0650688	098268315417	10	0.2	10	2	44.00
	WP18P-120812PB	3/4" CF x 1/2" CF x 3/4" CF	0650689	098268315424	10	0.3	10	3	45.75
	WP18P-120808PB	3/4" CF x 1/2" CF x 1/2" CF	0650690	098268315653	10	0.2	10	2	45.75
	WP18P-121216PB	3/4" CF x 3/4" CF x 1" CF	0650691	098268315660	10	0.4	10	4	87.75
	WP18P-161608PB	1" CF x 1" CF x 1/2" CF	0650692	098268315677	10	0.5	10	5	93.50
	WP18P-161212PB	1" CF x 3/4" CF x 3/4" CF	0650693	098268315684	10	0.5	10	5	106.50
	WP18P-161612PB	1" CF x 1" CF x 3/4" CF	0650694	098268315691	10	0.5	10	5	106.50
WP18P-16PB	1" CF x 1" CF x 1" CF	0650695	098268315707	5	0.5	10	5	57.25	

Bulk

1 2 3

LEAD FREE*	WP18P-08	1/2" CF x 1/2" CF x 1/2" CF	0650696	098268315714	100	2.0	–	–	279.00
	WP18P-12	3/4" CF x 3/4" CF x 3/4" CF	0650698	098268315738	100	3.0	–	–	399.00
	WP18P-121208	3/4" CF x 3/4" CF x 1/2" CF	0650699	098268315745	100	2.0	–	–	399.00
	WP18P-120812	3/4" CF x 1/2" CF x 3/4" CF	0650800	098268315752	100	3.0	–	–	403.50
	WP18P-120808	3/4" CF x 1/2" CF x 1/2" CF	0650801	098268315769	100	2.0	–	–	403.50

*The wetted surface of this product contacted by consumable water contains less than 0.25% of lead by weight.

Net Content = Quantity of individual pieces or feet contained in the consumer unit.

PEX Fittings – Poly-Alloy

Swivel Couplings

For connecting 3/8" or 1/2" WaterPEX® supply lines directly from manifold or branch supply to faucet. (Not needed if using WaterPEX® Risers or Flexible Risers.)



Model No.	Description/Size	Ordering Code	UPC	Net Content	Consumer Unit Weight (lbs)	Case Qty	Case Weight (lbs)	List Price
-----------	------------------	---------------	-----	-------------	----------------------------	----------	-------------------	------------

PolyBag

Straight

WP25P-0608PB	3/8" CF x 1/2" FIP - Swivel	0650807	098268315950	25	0.8	4	3	\$ 134.00
WP25P-08PB	1/2" CF x 1/2" FIP - Swivel	0650808	098268315967	25	0.8	4	3	130.50
WP25P-12PB	3/4" x 3/4" FIP - Swivel	0650809	098268315981	25	1.3	4	5	148.00

Angle

WP26P-08PB	1/2" CF x 1/2" FIP - Swivel	0650810	098268316018	10	0.4	10	4	65.25
WP26P-12PB	3/4" CF x 3/4" FIP - Swivel	0650811	098268316025	5	0.3	10	3	37.25

Test Plugs

Used for pressure testing the system.



Model No.	Description/Size	Ordering Code	UPC	Net Content	Consumer Unit Weight (lbs)	Case Qty	Case Weight (lbs)	List Price
-----------	------------------	---------------	-----	-------------	----------------------------	----------	-------------------	------------

PolyBag

WP27P-08PB	1/2" CF	0650818	098268316100	10	0.5	10	5	\$ 17.25
WP27P-12PB	3/4" CF	0650819	098268316179	10	0.1	10	1	23.25
WP27P-16PB	1" CF	0650820	098268316193	10	0.2	10	2	28.75

Bulk

WP27P-08	1/2" CF	0650822	098268316285	100	50.0	–	–	145.50
----------	---------	---------	--------------	-----	------	---	---	--------

Pipe Support and Mounting Accessories

Stubout Brackets and Elbows

PEX Stubout Brackets and Grommets-Galvanized

PEX Stubout Brackets and Grommets are used to position and align PEX stubouts at fixtures or along joists or studs. The bracket is secured to wood framing with nails. The grommet is inserted into the bracket, then the WaterPEX® slides through the grommet. This creates a secure, stable stubout for attaching valve stops. Grommets are made of fire-retardant materials.

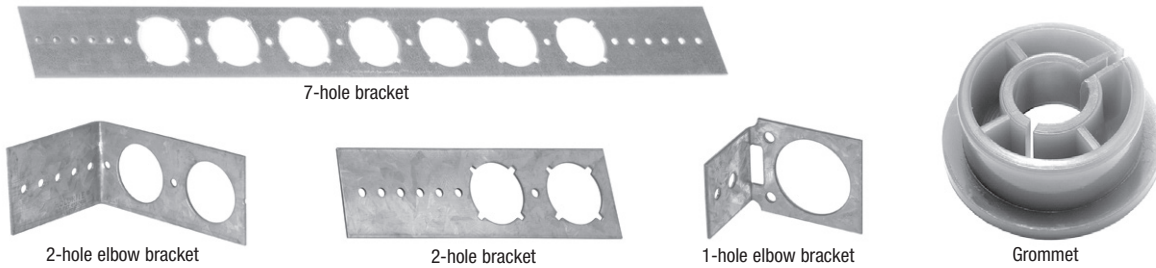

Model No.	Description/Size	Ordering Code	UPC	Net Content	Consumer Unit Weight (lbs)	Case Qty	Case Weight (lbs)	List Price
WPSB-7S	Bracket - 7-hole	0650828	098268316469	50	29.0	—	—	896.50
WPIG-08	1/2" Insert Grommet for Galvanized Bracket	0650829	098268316476	10	2.0	10	20	29.00
WPIG-12	3/4" Insert Grommet for Galvanized Bracket	0650830	098268316605	10	2.7	10	27	29.00

Putting it Together

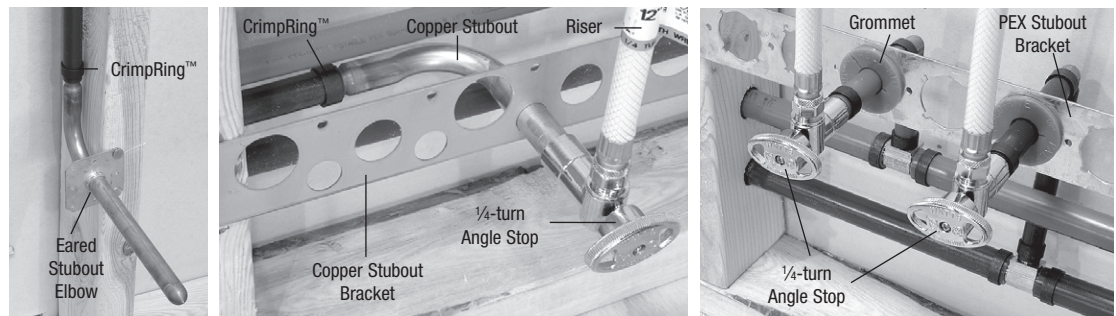

Pipe Support and Mounting Accessories

Stubout Brackets and Elbows

Copper Stubout Brackets and Elbows

- **Copper Stubout Brackets** are used to position and align copper pipe and/or stubout elbows at plumbing fixtures (as an alternative to using PEX Stubouts, see below). The brackets are nailed to the wood framing, then the copper pipe or stubouts are soldered to the brackets. This creates a secure, stable stubout for attaching valve stops.
- **Copper Stubout Elbows.** 90° Barbed transition from WaterPEX® supply piping to fixture supply piping.

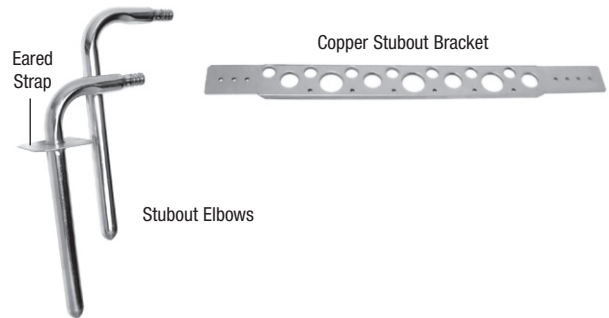

Model No.	Description/Size	Ordering Code	UPC	Net Content	Consumer Unit Weight (lbs)	Case Qty	Case Weight (lbs)	List Price
WPSB-A	1/2", 3/4" and 1" Bracket	0650832	098268316629	50	11.0	—	—	\$ 989.50
WPSB-B8	1/2" CF x 1/2" Nom. Stubout Elbow	0650833	098268316674	10	2.8	10	28	133.00
WPSB-B12	1/2" CF x 1/2" Nom. Stubout Elbow	0650834	098268316704	4	1.4	10	14	75.25
WPSB-C	3/8" CF x 1/2" Nom. Stubout Elbow w/Eared Strap	0650836	098268316735	5	1.8	5	9	109.00
WPSB-D	1/2" CF x 1/2" Nom. Stubout Elbow w/Eared Strap	0650837	098268316742	5	1.8	5	9	102.50

LEAD FREE*

Bend Supports

- **Mid-run Bend Supports.** Mid-run Bend Supports help WaterPEX® bend in walls and joist cavities.
- **Terminal Bend Supports.** Terminal Bend Supports are plastic elbows that are used at the ends of the WaterPEX® to make smooth, clean transitions up to manifolds.

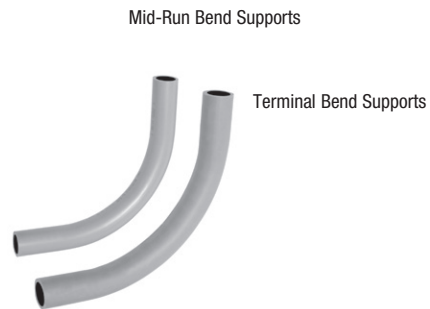

Model No.	Description/Size	Ordering Code	UPC	Net Content	Consumer Unit Weight (lbs)	Case Qty	Case Weight (lbs)	List Price
WPBS-08M	1/2" Mid Run	0650839	098268316780	10	1.0	10	10	\$ 70.50
WPBS-12M	3/4" Mid Run	0650840	098268316797	10	1.7	10	17	187.00
WPBS-0608T	3/8" and 1/2" Terminal	0650841	098268316919	10	22.0	—	—	56.25
WPBS-12T	3/4" Terminal	0650842	098268316926	10	21.0	—	—	82.25

Pipe Support and Mounting Accessories

WaterPEX® Fasteners

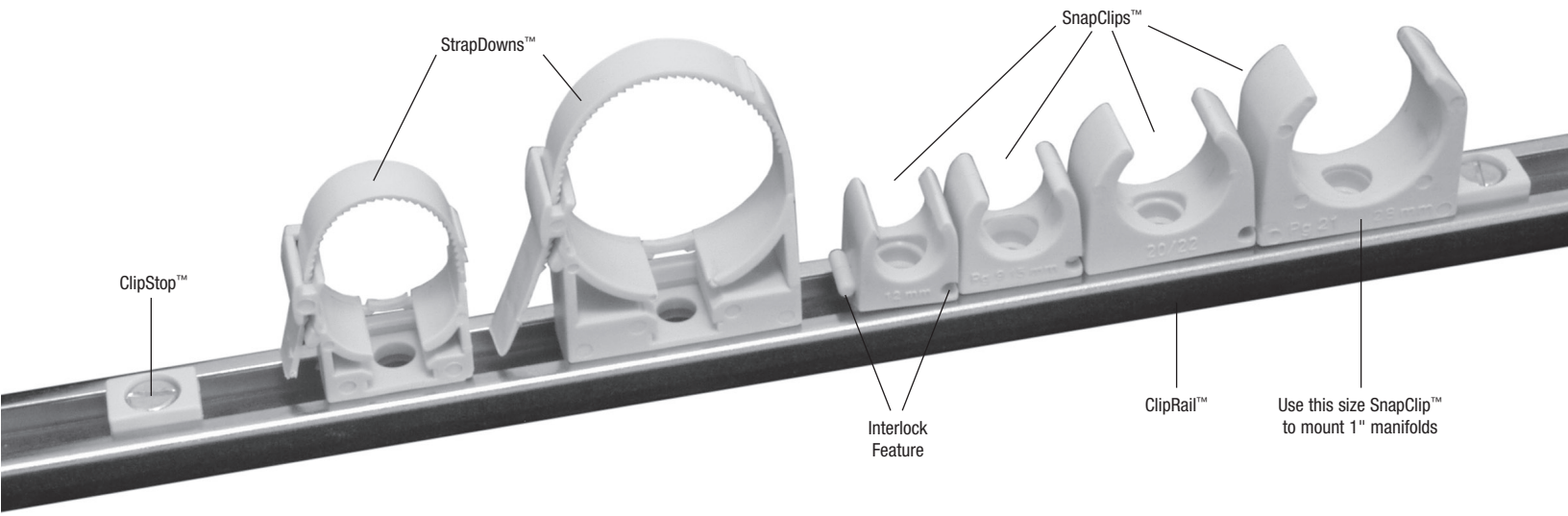

SnapClip™

For holding WaterPEX® tubing firmly in place. SnapClips™ can be used with or without ClipRails™. They can be interlocked for a very tight arrangement. Anchor them with a single screw through base (screws not included).

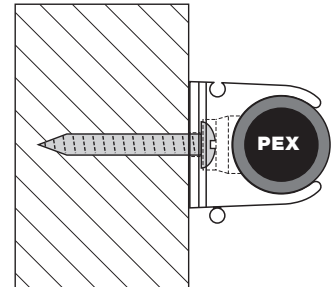
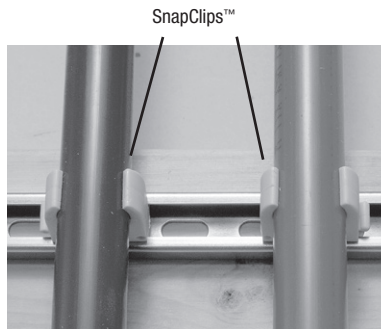

Model No.	Description/Size	Ordering Code	UPC	Net Content	Consumer Unit Weight (lbs)	Case Qty	Case Weight (lbs)	List Price
PolyBag								
WPSC-06PB	3/8" WaterPEX	0650903	098268317718	10	0.2	10	2	\$ 9.00
WPSC-08PB	1/2" WaterPEX	0650904	098268317725	10	0.2	10	2	13.25
WPSC-12PB	3/4" WaterPEX	0650905	098268317763	10	0.2	10	2	14.25
WPSC-16PB	1" WaterPEX	0650906	098268317770	10	0.2	10	2	16.00
Bulk								
WPSC-06	3/8" WaterPEX	0650912	098268317831	100	1.0	–	–	62.75
WPSC-08	1/2" WaterPEX	0650913	098268317848	100	1.0	–	–	98.75
WPSC-12	3/4" WaterPEX	0650914	098268317855	100	1.0	–	–	117.50
WPSC-16	1" WaterPEX	0650915	098268317862	100	1.0	–	–	143.00

PEX Manifold Bracket

This bracket will hold a pair of Watts Copper Manifolds — one hot and one cold. This narrow bracket fits within a 3½" wall or can be mounted external to the wall.



Model No.	Description/Size	Ordering Code	UPC	Net Content	Consumer Unit Weight (lbs)	Case Qty	Case Weight (lbs)	List Price
PolyBag								
WPUMB-1PB	PEX Manifold Bracket - 2	0650911	098268317824	2	3.0	1	3	\$ 124.50

WaterPEX® Tools

Basic Tubing Cutter

All-metal construction makes this cutter superior to plastic models.



Model No.	Description/Size	Ordering Code	UPC	Net Content	Consumer Unit Weight (lbs)	Case Qty	Case Weight (lbs)	List Price
PolyBag								
WPTC-1PB	Basic Tubing Cutter	0650927	098268318197	1	1.0	–	–	\$ 52.75
Bulk								
WPTC-1	Basic Tubing Cutter	0650864	098268317176	10	5.0	–	–	514.00

Professional Tubing Cutter

Cuts WaterPEX® to length. This ratchet-style cutter is made of all-metal, heavy-duty construction and designed for the rigor of daily jobsite use.



Model No.	Description/Size	Ordering Code	UPC	Net Content	Consumer Unit Weight (lbs)	Case Qty	Case Weight (lbs)	List Price
PolyBag								
WPTC-2PB	Professional Tubing Cutter (ratchet type)	0650928	098268318227	1	1.0	–	–	\$ 93.50

Ratcheting Cinch Tool

Designed specifically for Watts WaterPEX® and Cinch Clamps. One hand use with the visual and audible indication of successful cinch. In-field calibration. Packaged in a heavy duty holster.

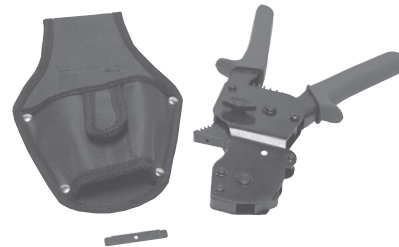

Model No.	Description/Size	Ordering Code	UPC	Net Content	Consumer Unit Weight (lbs)	Case Qty	Case Weight (lbs)	List Price
WPCCT-6	Ratcheting Cinch Tool	0651059	098268382983	1	2.0	–	–	\$ 597.00

PEX Installation Tools & Accessories

WaterPEX® Tools

Manual CinchClamp™ Tool

Manual CinchClamp™ Tool is designed for use of tubing and CinchClamp™ connections. WPCCT-2 comes in a heavy-duty holster with a gapping gauge and calibration bar.



Model No.	Description/Size	Ordering Code	UPC	Net Content	Consumer Unit Weight (lbs)	Case Qty	Case Weight (lbs)	List Price
WPCCT-2	Manual CinchClamp Tool	0651060	098268382990	1	3.0	–	–	\$ 399.00

RingMaster™ Crimp Tools

Larger tool for more leverage. Includes RingMaster™ fitted with crimping jaws. Other jaws can be purchased separately (see next page). 3/8", 1/2", 5/8", and 3/4" jaws fit 15" tool; 1" jaws fit only in 19" tool.



Model No.	Description/Size	Ordering Code	UPC	Net Content	Consumer Unit Weight (lbs)	Case Qty	Case Weight (lbs)	List Price
-----------	------------------	---------------	-----	-------------	----------------------------	----------	-------------------	------------

PolyBag

WPRM06-15PB	3/8" (15" tool)	0650929	098268318234	1	3.0	–	–	\$ 679.50
WPRM08-15PB	1/2" (15" tool)	0650930	098268318241	1	3.0	–	–	679.50
WPRM12-19PB	3/4" (15" tool)	0650931	098268318258	1	4.0	–	–	679.50
WPRM16-19PB	1" (19" tool)	0650932	098268318265	1	4.0	–	–	1,278.00

CrimpAll™ Tool Kit

Tough plastic tool kit helps you keep track of all your crimping tools. 15" CrimpAll™ tool, interchangeable 3/8", 1/2", 5/8", and 3/4" crimping jaws, Go/No-Go crimp gauge, and adjustment tools.



Model No.	Description/Size	Ordering Code	UPC	Net Content	Consumer Unit Weight (lbs)	Case Qty	Case Weight (lbs)	List Price
WPCATK-1	3/8" - 3/4" CrimpAll Kit 15"	0650872	098268317268	1	6.0	–	–	\$ 729.50

PEX Installation Tools & Accessories

WaterPEX® Tools

CrimpRing™ Removal Tool

A heavy duty tool for the removal of the WaterPEX CrimpRing™ without damaging PEX fittings.



Model No.	Description/Size	Ordering Code	UPC	Net Content	Consumer Unit Weight (lbs)	Case Qty	Case Weight (lbs)	List Price
WPCRT-1	CrimpRing Removal Tool	0651016	098268340563	1	2.0	–	–	\$ 119.00

WaterPEX® Unwinder

This is a must for any WaterPEX® installation. The Unwinder works for both barrier and non-barrier PEX. It can handle sizes through 1". The coil sits on the tripod and is held in place as it unwinds with four guide-bars. The WaterPEX® is uncoiled through a guide-ring that sits at the top of the unwinder.



Model No.	Description/Size	Ordering Code	UPC	Net Content	Consumer Unit Weight (lbs)	Case Qty	Case Weight (lbs)	List Price
WPUW-1	PEX Unwinder	0650866	098268317190	1	35.0	–	–	\$ 1,621.00

CrimpMaster™ Tools

Smaller, more compact for tight spaces.



Model No.	Description/Size	Ordering Code	UPC	Net Content	Consumer Unit Weight (lbs)	Case Qty	Case Weight (lbs)	List Price
PolyBag								
WPCMT-08PB	1/2" CrimpMaster Tool - 11"	0650888	098268317534	1	3.0	–	–	\$ 866.50
WPCMT-12PB	3/4" CrimpMaster Tool - 11"	0650889	098268317541	1	3.0	–	–	866.50

WaterPEX® Accessories

Washing Machine Shutoff Valves

Protects all connections, and comes with a knockout for safety drain line. Shuts off all water pressure to washing machines with a single easy-lever handle. Prevents water damage when your customer is away. Fitted for standard washing machine hose connections, with swivel 1/2" CrimpRing™ WaterPEX® connections to the house plumbing. Maximum temperature 180°F, maximum pressure 150psi. (Hoses sold separately.)

WaterOff Control Center



WaterOff Control Valve only



Model No.	Description/Size	Ordering Code	UPC	Net Content	Consumer Unit Weight (lbs)	Case Qty	Case Weight (lbs)	List Price
WPWMCC-1	WaterOff Valve w/Decorative Box	0650921	098268318029	1	3.0	–	–	\$ 317.50
WPWMV-2	WaterOff Valve Only	0650922	098268318036	1	1.0	–	–	252.50

Washing Machine Valve and Enclosure

Package comes complete with two individual 1/4-turn brass valves and white protective enclosure with faceplate. Valves are fitted for standard washing machine hose and 1/2" WaterPEX® CrimpRing™ fittings. The design allows for left, center or right valve and waste mounting. The 6 1/2" x 7 7/8" x 3" enclosure comes complete with brackets for nailing to house framing. (Hoses sold separately.)



Washing Machine Valve only

Model No.	Description/Size	Ordering Code	UPC	Net Content	Consumer Unit Weight (lbs)	Case Qty	Case Weight (lbs)	List Price
WPWME-1	Washing Machine Valve w/Enclosure	0650923	098268318043	1	3.0	10	30	\$ 111.00

Ice Maker Valves

Package comes complete with one 1/4-turn brass valve and white protective enclosure with faceplate. Valves are fitted for standard 1/4" compression ice maker and 1/2" WaterPEX® CrimpRing™ fitting. The 5 3/16" x 5 3/16" x 2 1/2" enclosure nails directly to house framing.



Ice Maker Valve only



Model No.	Description/Size	Ordering Code	UPC	Net Content	Consumer Unit Weight (lbs)	Case Qty	Case Weight (lbs)	List Price
LFWPIME-1	Ice Maker Valve and Enclosure	0653144	098268442564	1	1.0	10	10	\$ 87.50
LFWPIMV-1	Ice Maker Valve Only	0653145	098268442571	1	1.0	10	10	34.50

LEAD FREE

To locate your nearest Watts representative, please click on our *find a sales rep* locator on watts.com.

Represented by:

